



# PROFİL KATALOĐU

## **STANDART SERİLER**

[www.haseldisticaret.com](http://www.haseldisticaret.com)









**TÜRK STANDARDLARI ENSTİTÜSÜ**  
**TÜRK STANDARDLARINA UYGUNLUK BELGESİ**  
**TURKISH STANDARDS INSTITUTION**  
**CERTIFICATE OF CONFORMITY TO TURKISH STANDARDS**



<b>BELGE NUMARASI</b> REFERENCE NUMBER OF LICENCE	075027-TSE-01/02
<b>BELGENİN İLK VERİLİŞ TARİHİ</b> DATE OF FIRST ISSUE OF LICENCE	21.03.2013
<b>BELGENİN SON GEÇERLİLİK TARİHİ</b> LICENCE VALID UNTIL	31.12.2018
<b>BELGE SAHİBİ KURULUŞUN ADI</b> NAME OF THE LICENCE HOLDER	HİLAL ALÜMİNYUM İTHALAT İHRACAT SANAYİ VE TİCARET LİMİTED ŞİRKETİ
<b>BELGE SAHİBİ KURULUŞUN ADRESİ</b> ADDRESS OF THE LICENCE HOLDER	HÜRRIYET MAH. DR.CEMİL BENGÜ CAD. NO:62/2 KAĞITHANE İSTANBUL/TÜRKİYE
<b>ÜRETİM YERİ ADI</b> NAME OF THE MANUFACTURING PLACE	HİLAL ALÜMİNYUM İTHALAT İHRACAT SANAYİ VE TİCARET LİMİTED ŞİRKETİ
<b>ÜRETİM YERİ ADRESİ</b> ADDRESS OF THE MANUFACTURING PLACE	EDİRNE ORG. SAN. BÖLG. 5.CAD. NO:11/18 SÜLOĞLU EDİRNE / TÜRKİYE
<b>İPTAL EDİLEN BELGE NUMARASI (Varsa)</b> INDICATION OF SUPERSEDED LICENCE (if any)	075027-TSE-01/01
<b>TESCİLLİ TİCARİ MARKASI</b> REGISTERED TRADE MARK	ŞEKİL+HİLAL YAPI SAĞLIĞI İTHALAT İHRACAT SANAYİ VE TİCARET LTD. ŞTİ.
<b>İLGİLİ TÜRK STANDARDI</b> RELATED TURKISH STANDARD	TS EN 755-1 / Alüminyum ve alüminyum alaşımları – Ekstrüzyonla imal edilmiş tellik çubuk/çubuk, boru ve profiller – Bölüm 1: Muayene ve teslim için teknik şartlar / 09.03.2010
<b>BELGE KAPSAMI</b> SCOPE OF LICENCE	ALÜMİNYUM VE ALÜMİNYUM ALAŞIMLARI EKSTRÜZYONLA İMAL EDİLMİŞ LUMBOZ BORULAR – EN AW 6060 VE EN AW 6063 ALAŞIMINDAN İMAL EDİLMİŞ.

e-imzalı/e-signed

28.05.2018

Belgelendirme Merkezi Başkanı Adına  
AHMET NURSİ KARTAL

TSE İSTANBUL BELGELENDİRME MÜDÜRÜ

\*Bu belge, belgelendirilen ürünün, üretim yerinin Enstitümüzün belirlediği şartları karşıladığını da gösterir.

\*Bu belge hiç bir suretle tahrif edilemez, kısmen veya okunmasını zorlaştıracak şekilde çoğaltılamaz, kaza ve silini yapılamaz.

\*TSE İSTANBUL BELGELENDİRME MÜDÜRLÜĞÜ \* Adres: Çayırova Tren İstasyonu Yanı ÇAYIROVA/GEZBE \* Tel: 2627231273\* Faks: 2627231606

\*TSE BELGELENDİRME MERKEZİ BAŞKANLIĞI, Adres: Necatibey Cad. No:112 06100 Bakanlıklar/ANKARA – Tel: 0 312 416 64 81 / 416 64 27, Faks: 0 312 416 66 17

e-posta : bmb@tse.org.tr , web : www.tse.org.tr

<https://evrakkontrol.tse.org.tr/BelgeDogrulama.aspx?p=xllg8y7q> adresinden belgenin doğruluğunu ve geçerliliğini sorgulayınız.



1 / 1



**TÜRK STANDARDLARI ENSTİTÜSÜ**  
**TÜRK STANDARDLARINA UYGUNLUK BELGESİ**  
**TURKISH STANDARDS INSTITUTION**  
**CERTIFICATE OF CONFORMITY TO TURKISH STANDARDS**

Markanın Tanımı Description of the Mark  
TSE veya or  veya or Т С Е

<b>BELGE NUMARASI</b> REFERENCE NUMBER OF LICENCE	075027-TSE-04/02
<b>BELGENİN İLK VERİLİŞ TARİHİ</b> DATE OF FIRST ISSUE OF LICENCE	21.03.2013
<b>BELGENİN SON GEÇERLİLİK TARİHİ</b> LICENCE VALID UNTIL	31.12.2018
<b>BELGE SAHİBİ KURULUŞUN ADI</b> NAME OF THE LICENCE HOLDER	HİLAL ALÜMİNYUM İTHALAT İHRACAT SANAYİ VE TİCARET LİMİTED ŞİRKETİ
<b>BELGE SAHİBİ KURULUŞUN ADRESİ</b> ADDRESS OF THE LICENCE HOLDER	HÜRRİYET MAH. DR.CEMİL BENGÜ CAD. NO:62/2 KAĞITHANE İSTANBUL/TÜRKİYE
<b>ÜRETİM YERİ ADI</b> NAME OF THE MANUFACTURING PLACE	HİLAL ALÜMİNYUM İTHALAT İHRACAT SANAYİ VE TİCARET LİMİTED ŞİRKETİ
<b>ÜRETİM YERİ ADRESİ</b> ADDRESS OF THE MANUFACTURING PLACE	EDİRNE ORG. SAN. BÖLG. 5.CAD. NO:11/18 SULOĞLU EDİRNE / TÜRKİYE
<b>İPTAL EDİLEN BELGE NUMARASI (Varsa)</b> INDICATION OF SUPERSEDED LICENCE (if any)	075027-TSE-04/01
<b>TESCİLLİ TİCARİ MARKASI</b> REGISTERED TRADE MARK	ŞEKİL+HİLAL YAPI SAĞLIĞI İTHALAT İHRACAT SANAYİ VE TİCARET LTD. ŞTİ.
<b>İLGİLİ TÜRK STANDARDI</b> RELATED TURKISH STANDARD	TS EN 755-1 / Alüminyum ve alüminyum alaşımları – Ekstrüzyonla imal edilmiş tellik çubuk/çubuk, boru ve profiller – Bölüm 1: Muayene ve teslim için teknik şartlar / 09.03.2010
<b>BELGE KAPSAMI</b> SCOPE OF LICENCE	ALÜMİNYUM VE ALÜMİNYUM ALAŞIMLARI EKSTRÜZYONLA İMAL EDİLMİŞ YUVARLAK ÇUBUKLAR – EN AW 6060 VE EN AW 6063 ALAŞIMINDAN İMAL EDİLMİŞ.

e-imzalı/e-signed

28.05.2018

Belgelendirme Merkezi Başkanı Adına  
AHMET NURSİ KARTAL

TSE İSTANBUL BELGELENDİRME MÜDÜRÜ

\*Bu belge, belgelendirilen ürünün, üretim yeminin Enstitümüzün belirlediği şartları karşıladığını da gösterir.  
\*Bu belge hiç bir suretle tahrif edilemez, kısmen veya okunmasını zorlaştıracak şekilde çoğaltılamaz, kızırtı ve silinti yapılamaz.  
\*TSE İSTANBUL BELGELENDİRME MÜDÜRLÜĞÜ \* Adres: Çayirova Tren İstasyonu Yeni ÇAYIROVA/GEBZE \* Tel: 2627231273\* Faks: 2627231606  
\*TSE BELGELENDİRME MERKEZİ BAŞKANLIĞI; Adres: Necatibey Cad. No:112 06100 Bakanlıklar/ANKARA – Tel: 0 312 416 64 81 / 416 64 27, Faks: 0 312 416 68 17  
e-posta : bmb@tse.org.tr , web : www.iso.org.tr





**TÜRK STANDARDLARI ENSTİTÜSÜ**  
**TÜRK STANDARDLARINA UYGUNLUK BELGESİ**  
**TURKISH STANDARDS INSTITUTION**  
**CERTIFICATE OF CONFORMITY TO TURKISH STANDARDS**

Markanın Tanımı Description of the Mark  
TSE veya/ör  veya/ör T S E

<b>BELGE NUMARASI</b> REFERENCE NUMBER OF LICENCE	075027-TSE-03/02
<b>BELGENİN İLK VERİLİŞ TARİHİ</b> DATE OF FIRST ISSUE OF LICENCE	21.03.2013
<b>BELGENİN SON GEÇERLİLİK TARİHİ</b> LICENCE VALID UNTIL	31.12.2018
<b>BELGE SAHİBİ KURULUŞUN ADI</b> NAME OF THE LICENCE HOLDER	HİHAL ALÜMİNYUM İTHALAT İHRACAT SANAYİ VE TİCARET LİMİTED ŞİRKETİ
<b>BELGE SAHİBİ KURULUŞUN ADRESİ</b> ADDRESS OF THE LICENCE HOLDER	HÜRRİYET MAH. DR.CEMİL BENGÜ CAD. NO:62/2 KAĞITHANE İSTANBUL/TÜRKİYE
<b>ÜRETİM YERİ ADI</b> NAME OF THE MANUFACTURING PLACE	HİHAL ALÜMİNYUM İTHALAT İHRACAT SANAYİ VE TİCARET LİMİTED ŞİRKETİ
<b>ÜRETİM YERİ ADRESİ</b> ADDRESS OF THE MANUFACTURING PLACE	HÜRRİYET MAH. DR.CEMİL BENGÜ CAD. NO:62/2 KAĞITHANE İSTANBUL / TÜRKİYE
<b>İPTAL EDİLEN BELGE NUMARASI (Varsa)</b> INDICATION OF SUPERSEDED LICENCE (if any)	075027-TSE-03/01
<b>TESCİLLİ TİCARİ MARKASI</b> REGISTERED TRADE MARK	ŞEKİL+HİHAL YAPI SAĞLIĞI İTHALAT İHRACAT SANAYİ VE TİCARET LTD. ŞTİ.
<b>İLGİLİ TÜRK STANDARDI</b> RELATED TURKISH STANDARD	TS EN 755-1 / Alüminyum ve alüminyum alaşımları – Ekstrüzyonla imal edilmiş tellik çubuk/çubuk, boru ve profiller – Bölüm 1: Muayene ve teslim için teknik şartlar / 09.03.2010
<b>BELGE KAPSAMI</b> SCOPE OF LICENCE	ALÜMİNYUM VE ALÜMİNYUM ALAŞIMLARI EKSTRÜZYONLA İMAL EDİLMİŞ PROFİLLER – EN AW 6060 VE EN AW 6063 ALAŞIMINDAN İMAL EDİLMİŞ.

e-imzalı/e-signed

28.05.2018

Belgelendirme Merkezi Başkanı Adına  
AHMET NURSİ KARTAL

TSE İSTANBUL BELGELENDİRME MÜDÜRÜ

\*Bu belge, belgelendirilen ürünün, üretim yerinin, Enstitümüzün belirlediği şartları karşıladığını da gösterir.  
\*Bu belge hiç bir suretle tahrif edilemez, kısmen veya okunmasını zorlaştıracak şekilde çoğaltılamaz, kazıntı ve silinti yapılamaz.  
\*TSE İSTANBUL BELGELENDİRME MÜDÜRLÜĞÜ \* Adres: Çayyova Tren İstasyonu Yanı ÇAYIROVA/GEZİZE \* Tel: 2627231273 \* Faks: 2627231806  
\*TSE BELGELENDİRME MERKEZİ BAŞKANLIĞI; Adres: Necatibey Cad. No:112 06100 Bakanlıklar/ANKARA – Tel: 0 312 416 64 81 / 416 64 27, Faks: 0 312 416 66 17  
e-posta : tse@tse.org.tr , web : www.tse.org.tr

<https://evrakkontrol.tse.org.tr/BelgeDogrulama.aspx?p=d8ihgwn> adresinden belgenin doğruluğunu ve geçerliliğini sorgulayınız.



1 / 1



**TÜRK STANDARDLARI ENSTİTÜSÜ**  
**TÜRK STANDARDLARINA UYGUNLUK BELGESİ**  
**TURKISH STANDARDS INSTITUTION**  
**CERTIFICATE OF CONFORMITY TO TURKISH STANDARDS**

Markanın Tanımı Description of the Mark  
**TSE** veya/or  veya/or **T S W**

<b>BELGE NUMARASI</b> REFERENCE NUMBER OF LICENCE	075027-TSE-02/02
<b>BELGENİN İLK VERİLİŞ TARİHİ</b> DATE OF FIRST ISSUE OF LICENCE	21.03.2013
<b>BELGENİN SON GEÇERLİLİK TARİHİ</b> LICENCE VALID UNTIL	20.09.2018
<b>BELGE SAHİBİ KURULUŞUN ADI</b> NAME OF THE LICENCE HOLDER	HİLAL ALÜMİNYUM İTHALAT İHRACAT SANAYİ VE TİCARET LIMITED ŞİRKETİ
<b>BELGE SAHİBİ KURULUŞUN ADRESİ</b> ADDRESS OF THE LICENCE HOLDER	HÜRRİYET MAH. DR.CEMİL BENGÜ CAD. NO:62/2 KAĞITHANE İSTANBUL/TÜRKİYE
<b>ÜRETİM YERİ ADI</b> NAME OF THE MANUFACTURING PLACE	HİLAL ALÜMİNYUM İTHALAT İHRACAT SANAYİ VE TİCARET LIMITED ŞİRKETİ
<b>ÜRETİM YERİ ADRESİ</b> ADDRESS OF THE MANUFACTURING PLACE	EDİRNE ORG. SAN. BÖLG. 5.CAD. NO:11/18 SÜLOĞLU EDİRNE / TÜRKİYE
<b>İPTAL EDİLEN BELGE NUMARASI (Varsa)</b> INDICATION OF SUPERSEDED LICENCE (if any)	075027-TSE-02/01
<b>TESCİLLİ TİCARİ MARKASI</b> REGISTERED TRADE MARK	ŞEKİL+HİLAL YAPI SAĞLIĞI İTHALAT İHRACAT SANAYİ VE TİCARET LTD. ŞTİ.
<b>İLGİLİ TÜRK STANDARDI</b> RELATED TURKISH STANDARD	TS EN 12020-1 / Alüminyum ve alüminyum alaşımları - EN AW- 6060 ve EN AW- 6063 alaşımlarından ekstrüzyon ile imal edilmiş hassas profiller - Bölüm 1: Teknik muayene ve teslim şartları / 02.03.2010 -- TS EN 12020-2 / Alüminyum ve alüminyum alaşımları - EN AW- 6060 ve EN AW- 6063 alaşımlarından ekstrüzyon ile imal edilmiş hassas profiller - Bölüm 2: Boyut ve şekil toleransları / 02.03.2010
<b>BELGE KAPSAMI</b> SCOPE OF LICENCE	

\*ALÜMİNYUM HASSAS PROFİLLER  
EN AW 6060 VE EN AW 6063 Alaşımlı Malzemelerden Isıl Bariyerli ve Bariyersiz profiller

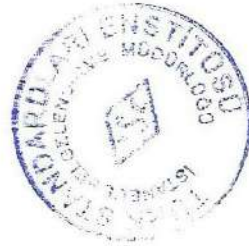

21..101/2018  
Belgelendirme Merkezi Başkanı Adına  
AHMET NURSI KARTAL

TSE İSTANBUL BELGELENDİRME MÜDÜRÜ

\*Bu belge, belgelendirilen ürünün, üretim yerinin Enstitümüzün belirlediği şartları karşıladığını da gösterir.  
\*Bu belge hiç bir suretle tahrif edilemez, kısmen veya okunmasını zorlaştıracak şekilde çoğaltılamaz, kazıntı ve silinti yapılamaz.  
\*TSE İSTANBUL BELGELENDİRME MÜDÜRLÜĞÜ \* Adres: Çayırova Tren İstasyonu Yanı ÇAYIROVA/GEBZE \* Tel: 2627231273 \* Faks: 2627231806  
\*TSE BELGELENDİRME MERKEZİ BAŞKANLIĞI, Adres: Necatibey Cad. No:112 06100 Bakanlıklar/ANKARA - Tel: 0 312 416 64 81 / 416 64 27, Faks: 0 312 416 66 17  
e-posta : bmb@tse.org.tr , web : www.tse.org.tr

<https://evrakkontrol.tse.org.tr/BelgeDogrulama.aspx?p=ic6i79hz> adresinden belgenin doğruluğunu ve geçerliliğini sorgulayınız.







**TÜRK STANDARDLARI ENSTİTÜSÜ**  
**TÜRK STANDARDLARINA UYGUNLUK BELGESİ**  
**TURKISH STANDARDS INSTITUTION**  
**CERTIFICATE OF CONFORMITY TO TURKISH STANDARDS**

Markanın Tanımı Description of the Mark  
TSE veya/or  veya/or T S E

<b>BELGE NUMARASI</b> REFERENCE NUMBER OF LICENCE	075027-TSE-01/02
<b>BELGENİN İLK VERİLİŞ TARİHİ</b> DATE OF FIRST ISSUE OF LICENCE	21.03.2013
<b>BELGENİN SON GEÇERLİLİK TARİHİ</b> LICENCE VALID UNTIL	31.12.2018
<b>BELGE SAHİBİ KURULUŞUN ADI</b> NAME OF THE LICENCE HOLDER	HİHAL ALÜMİNYUM İTHALAT İHRACAT SANAYİ VE TİCARET LİMİTED ŞİRKETİ
<b>BELGE SAHİBİ KURULUŞUN ADRESİ</b> ADDRESS OF THE LICENCE HOLDER	HÜRRIYET MAH. DR.CEMİL BENGÜ CAD. NO:62/2 KAĞITHANE İSTANBUL/TÜRKİYE
<b>ÜRETİM YERİ ADI</b> NAME OF THE MANUFACTURING PLACE	HİHAL ALÜMİNYUM İTHALAT İHRACAT SANAYİ VE TİCARET LİMİTED ŞİRKETİ
<b>ÜRETİM YERİ ADRESİ</b> ADDRESS OF THE MANUFACTURING PLACE	EDİRNE ORG. SAN. BÖLG. 5.CAD. NO:11/18 SÜLOĞLU EDİRNE / TÜRKİYE
<b>İPTAL EDİLEN BELGE NUMARASI (Varsa)</b> INDICATION OF SUPERSEDED LICENCE (if any)	075027-TSE-01/01
<b>TESCİLLİ TİCARİ MARKASI</b> REGISTERED TRADE MARK	ŞEKİL+HİHAL YAPI SAĞLIĞI İTHALAT İHRACAT SANAYİ VE TİCARET LTD. ŞTİ.
<b>İLGİLİ TÜRK STANDARDI</b> RELATED TURKISH STANDARD	TS EN 755-1 / Alüminyum ve alüminyum alaşımları – Ekstrüzyonla imal edilmiş tellik çubuk/çubuk, boru ve profiller – Bölüm 1: Muayene ve teslim için teknik şartlar / 09.03.2010
<b>BELGE KAPSAMI</b> SCOPE OF LICENCE	ALÜMİNYUM VE ALÜMİNYUM ALAŞIMLARI EKSTRÜZYONLA İMAL EDİLMİŞ LUMBOZ BORULAR – EN AW 6060 VE EN AW 6063 ALAŞIMINDAN İMAL EDİLMİŞ.

e-izmalı/e-signed

28.05.2018

Belgelendirme Merkezi Başkanı Adına  
AHMET NURSİ KARTAL

TSE İSTANBUL BELGELENDİRME MÜDÜRÜ

\*Bu belge, belgelendirilen ürünün, üretim yerinin Enstitümüzün belirlediği şartları karşıladığını da gösterir.

\*Bu belge hiç bir suretle tahrif edilemez, kısmen veya okunmasını zorlaştıracak şekilde çoğaltılamaz, kazınmaz ve silinmez.

\*TSE İSTANBUL BELGELENDİRME MÜDÜRLÜĞÜ \* Adres: Çayırova Tren İstasyonu Yanı ÇAYIROVA/GEZİRE \* Tel: 2627231273\* Faks: 2627231606

\*TSE BELGELENDİRME MERKEZİ BAŞKANLIĞI, Adres: Necatibay Cad. No:112 06100 Bakanlıkları/ANKARA – Tel: 0 312 416 64 81 / 416 64 27, Faks: 0 312 416 66 17  
e-posta : bmb@tse.org.tr , web : www.tse.org.tr

<https://evrakkontrol.tse.org.tr/BelgeDogrulama.aspx?p=xllg8y7q> adresinden belgenin doğruluğunu ve geçerliliğini sorgulayınız.



1 / 1



**TÜRK STANDARDLARI ENSTİTÜSÜ**  
**TÜRK STANDARDLARINA UYGUNLUK BELGESİ**  
**TURKISH STANDARDS INSTITUTION**  
**CERTIFICATE OF CONFORMITY TO TURKISH STANDARDS**

Markanın Tanımı Description of the Mark  
TSE veya or  veya or T S E

<b>BELGE NUMARASI</b> REFERENCE NUMBER OF LICENCE	075027-TSE-04/02
<b>BELGENİN İLK VERİLİŞ TARİHİ</b> DATE OF FIRST ISSUE OF LICENCE	21.03.2013
<b>BELGENİN SON GEÇERLİLİK TARİHİ</b> LICENCE VALID UNTIL	31.12.2018
<b>BELGE SAHİBİ KURULUŞUN ADI</b> NAME OF THE LICENCE HOLDER	HİLAL ALÜMİNYUM İTHALAT İHRACAT SANAYİ VE TİCARET LİMİTED ŞİRKETİ
<b>BELGE SAHİBİ KURULUŞUN ADRESİ</b> ADDRESS OF THE LICENCE HOLDER	HÜRRİYET MAH. DR.CEMİL BENGÜ CAD. NO:62/2 KAĞITHANE İSTANBUL/TÜRKİYE
<b>ÜRETİM YERİ ADI</b> NAME OF THE MANUFACTURING PLACE	HİLAL ALÜMİNYUM İTHALAT İHRACAT SANAYİ VE TİCARET LİMİTED ŞİRKETİ
<b>ÜRETİM YERİ ADRESİ</b> ADDRESS OF THE MANUFACTURING PLACE	EDİRNE ORG. SAN. BÖLG. 5.CAD. NO:11/18 SULOĞLU EDİRNE / TÜRKİYE
<b>İPTAL EDİLEN BELGE NUMARASI (Varsa)</b> INDICATION OF SUPERSEDED LICENCE (if any)	075027-TSE-04/01
<b>TESCİLLİ TİCARİ MARKASI</b> REGISTERED TRADE MARK	ŞEKİL+HİLAL YAPI SAĞLIĞI İTHALAT İHRACAT SANAYİ VE TİCARET LTD. ŞTİ.
<b>İLGİLİ TÜRK STANDARDI</b> RELATED TURKISH STANDARD	TS EN 755-1 / Alüminyum ve alüminyum alaşımları – Ekstrüzyonla imal edilmiş tellik çubuk/çubuk, boru ve profiller – Bölüm 1: Muayene ve teslim için teknik şartlar / 09.03.2010
<b>BELGE KAPSAMI</b> SCOPE OF LICENCE	

**ALÜMİNYUM VE ALÜMİNYUM ALAŞIMLARI**

EKSTRÜZYONLA İMAL EDİLMİŞ YUVARLAK ÇUBUKLAR – EN AW 6060 VE EN AW 6063 ALAŞIMINDAN İMAL EDİLMİŞ.

e-imzalı/e-signed

28.05.2018

Belgelendirme Merkezi Başkanı Adına  
AHMET NURSI KARTAL

TSE İSTANBUL BELGELENDİRME MÜDÜRÜ

\*Bu belge, belgelendirilen ürünün, üretim yennin Enstitümüzün belirlediği şartları karşıladığını da gösterir.

\*Bu belge hiç bir suretle tahrif edilemez, kısmen veya okunmasını zorlaştıracak şekilde çoğaltılamaz, kızıntı ve silinti yapılamaz.

\*TSE İSTANBUL BELGELENDİRME MÜDÜRLÜĞÜ \* Adres: Çayirova Tren İstasyonu Yanı ÇAYIROVA/GEBZE \* Tel: 2627231273\* Faks: 2627231606

\*TSE BELGELENDİRME MERKEZİ BAŞKANLIĞI; Adres: Necatibey Cad. No:112 06100 Bakanlıklar/ANKARA – Tel: 0 312 416 64 81 / 416 64 27. Faks: 0 312 416 88 17

e-posta : bmb@tse.org.tr , web : www.tse.org.tr

<https://evrakkontrol.tse.org.tr/BelgeDogrulama.aspx?p=99> jabyag adresinden belgenin doğruluğunu ve geçerliliğini sorgulayınız.





## QUALITY MANAGEMENT SYSTEM CERTIFICATE

Universal GmbH  
Certification Services

This certificate is granted to the organization,

**Hilal Aluminyum Ith. Ihr. San. Ve Tic. Ltd. Sti.**

**Dr. Cemil Bengu Cad. No:62/2 Kagithane / Istanbul / Turkey**  
**Factory: Edirne Organize San. Bolgesi 5.Cad.**  
**No:11/8 Suluoglu / Edirne / Turkey**

by review of SA2.007231 numbered report for the scope

**The Manufacturing and Sale of Aluminium Profile Import &  
Export and Wholesale of Building Materials and  
Construction Equipments**

to certify that a quality management system in accordance with  
standard's clauses is established and being implemented

### DIN EN ISO 9001:2015

**Certificate No : QMS 0116 007231**

**Original Certification Date : 2016 - 01 - 05**

**Issue / Revised Date : 2018 - 01 - 04**

**Expiry Date : 2019 - 01 - 04**

**Certificate Period : 3 Years ( 3<sup>rd</sup> Year )**



Deutsche  
Akkreditierungsstelle  
D-ZM-16058-01-00

  
Universal GmbH



UNICERT®



## KALİTE YÖNETİM SİSTEMİ SERTİFİKASI

Universal GmbH  
Belgelendirme Hizmetleri

Bu sertifika,

**Hilal Alüminyum İth. İhr. San. Ve Tic. Ltd. Şti.**

Dr. Cemil Bengü Cad. No:62/2 Kağıthane/ İstanbul/ Türkiye  
Fabrika: Edirne Organize San. Bölgesi 5.Cad.  
No:11/8 Suluoğlu/ Edirne/ Türkiye

kuruluşunun,

**Alüminyum Profil Üretimi ve Satışı ile İnşaat Malzemeleri ve  
İnşaat Makineleri İthalat, İhracat ve Toptan Satışı**

kapsamında, SA2.007231 sayılı rapordaki inceleme ile

**DIN EN ISO 9001:2015**

standardının şartlarına uyan bir kalite yönetim sistemi  
kurduğunu ve uyguladığını onaylamak üzere verilmiştir.

**Sertifika No : QMS 0116 007231**

**İlk Yayın Tarihi : 2016 - 01 - 05**

**Yayın / Revizyon Tarihi : 2018 - 01 - 04**

**Geçerlilik Tarihi : 2019 - 01 - 04**

**Belge Periyodu : 3 Yıl ( 3.Yıl )**

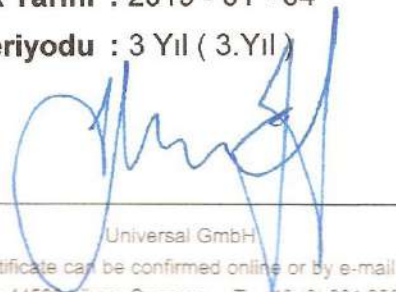

  
Universal GmbH



The authenticity of this certificate can be confirmed online or by e-mail to the Head Office via:



# TÜRK LOYDU

TL İş No : 9748  
TL Work No

## FABRİKA ÜRETİM KONTROL UYGUNLUK BELGESİ CERTIFICATE OF CONFORMITY OF THE FACTORY PRODUCTION CONTROL

<1785-CPR-0036>

Avrupa Parlamentosu ve Konseyinin 9 Mart 2011 tarihli 305/2011/AB Yapı Malzemeleri Yönetmeliği'ne uygun olarak bu sertifika aşağıdaki yapı malzemeleri için  
*In compliance with Regulation 305/2011/EU of the European Parliament and of the Council of 9 March 2011 (the Construction Products Regulation or CPR), this certificate applies to the construction product*

### Yapısal amaçlı alüminyum ve alüminyum alaşımlı ürünler Aluminium and aluminium alloy products for structural purposes

Ürün Product	Genel Hükümler General Conditions	Spesifik Şartlar Specific Conditions		Boyutlar Dimensions	Alaşım Alloys
		Mekanik Özellikler Mechanical Spec.	Toleranslar Tolerances		
Ekstrüzyonla İmalat Edilmiş Profil	EN 755-1	EN 755-2	EN 755-9	Çevre çapı 155 mm'den küçük ürünler (≥Ø 155mm) Products with circumference diameter less than 155 mm (≥Ø 155mm)	EN AW 6060 EN AW 6063
Ekstrüzyonla İmalat Edilmiş Hassas Profil	EN 12020-1	EN 755-2	EN 12020-2	Çevre çapı 155 mm'den küçük ürünler (≥Ø 155 mm) Products with circumference diameter less than 155 mm (≥Ø 155mm)	

placed on the market under the name or trade mark of

**HİHAL ALÜMİNYUM İTHALAT VE İHRACAT SAN. VE TİC. LTD. ŞTİ.**  
Hürriyet Mah. Dr. Cemil Bengü Cad. No 62 Kağıthane İSTANBUL  
tarafından

and produced in the manufacturing plant (s)

**HİHAL ALÜMİNYUM İTHALAT VE İHRACAT SAN. VE TİC. LTD. ŞTİ.**  
Edirne Org. San. Bölğ. 5. Cad. No:11-8, Domurcalı / Süloğlu / EDİRNE  
tesisinde üretilmektedir.

Bu belge standardın Ek ZA'sında açıklanan performans süreklilik değerlendirme ve doğrulama ile ilgili tüm hükümlerin karşılandığını gösterir.

*This certificate attests that all provisions concerning the assessment and verification of constancy of performance described in Annex ZA of the standard(s)*

**EN 15088:2005**

Sistem 2+ uygulanmıştır ve  
under system 2+ is applied and that

fabrika üretim kontrolü yukarıda belirtilen tüm öngörülen şartları yerine getirmektedir.  
the factory production control fulfils all the prescribed requirements set out above.

Belgelendirme tarihi/Date of certification : 11.06.2018  
İlk Belgelendirme tarihi/Date of initial certification : 06.03.2015  
Belge geçerlilik tarihi/Date of certificate expiry : 05.03.2021

**Hasan MUFTUOĞLU**

Ürün Belgelendirme Komitesi Başkanı V.

Act. Head of Product Certification Committee

Yönetmeliğe uygun olarak ürünün sorumluluğu imalatçı veya yetkili temsilcisine aittir. Yönetmelikte belirtilen üretim/ürün değerlendirme sistemine tamamen uyulduğu zaman uygunluk işareti üzerine konulabilir ve uygunluk beyanı düzenlenebilir.

Türk Loydu'nun herhangi bir ihmali dolayısıyla sebep olduğu kayıp ve hasarların ispatlanması durumunda, kayıplara "Mesleki Sorumluluk Sigortası" limitleri dahilinde tazminat ödenir.

The product liability rests with the manufacturer or his representative in accordance with the directive. The conformity marking may only be affixed to the product and a Declaration of Conformity may only be issued when the production/product assessment system referred in the directive is fully complied with.

If any person suffers loss or damage which is proved to have been caused by any negligent act or omission of Türk Loydu, that loss compensated within the limits of "Professional Indemnity Insurance".

TÜRK LOYDU – Evliya Çelebi Mh. Tersaneler Cd. No.26/1 – 34944 Tuzla/İstanbul – Tel: 0216 581 37 00 – e-mail: endustri@turkloydu.org



# TÜRK LOYDU

Sertifika Tarihi: 11.06.2018  
Certificate Date

TL İş No: 9749  
TL Work No

## DEMİRYOLU ARAÇLARI VE BİLEŞENLERİNİN KAYNAĞI SERTİFİKASI WELDING OF RAILWAY VEHICLES AND COMPONENTS CERTIFICATE EN 15085-2:2007

**İmalatçı Adı ve Adresi** : HİLAL ALÜMİNYUM İTHALAT VE İHRACAT SAN. VE TİC. LTD. ŞTİ.  
*Manufacturer and Address* : Edirne Org. San. Bölğ. 5. Cad. No:11-8, Domurcalı / Süloğlu / EDİRNE

Yukarıda belirtilen firma aşağıdaki tanımlanmış uygulama kapsamında kaynak işleri yapılması için belgelendirilmiştir.

*Is certificate that it is qualified for carrying out welding jobs in the area of application of:*

**Sertifikasyon Seviyesi** : CL3  
*Certification Level*

**Uygulama Alanı** : Demiryolu araçlarının ticari tedarik parçalarının yeni yapım, değiştirme ve  
*Field of Application* : onarımı  
*New build, conversion and repair of parts of trade supply parts for rail vehicles*

**Sertifikasyon Aralığı** :  
*Range of Certification*

Kaynak Yöntemi/ Welding Process EN ISO 4063	Malzeme Grubu/ Material Group CEN ISO/TR 15608	Boyutlar/ Dimensions	Yorumlar/ Comments
131	22.2	1≤t≤40 mm	FW
135	1.1	3mm≤t≤40 mm	FW

<b>Sorumlu Kaynak Koordinatörü</b> <i>Responsible Welding Coordinator</i>	:	--			
<b>Aynı Haklara Sahip Vekil</b> <i>Deputy With Equal Rights</i>	:	--			
<b>Vekil</b> <i>Deputy</i>	:	--			
<b>Yorumlar</b> <i>Comments</i>	:	--			
<b>Sertifika No</b> <i>Certificate No</i>	:	TL/15085/CL3/9749-18-04526/0/2018			
<b>Geçerlilik</b> <i>Valid</i>	:	10.03.2021			
<b>İlk belgelendirme tarihi</b> <i>Date of initial certification</i>	:	11.03.2015	<b>Yayın</b> <i>Issued on</i>	:	11.06.2018
<b>Denetçi</b> <i>Auditor</i>	:	Nurdan ERGAN, Ayşem ERGÜN COŞKUN			

**Hasan MUFTUOĞLU**  
Ürün Belgelendirme Komitesi Başkanı V.  
*Act. Head of Product Certification Committee*

**Murat DEVREZ**  
Teknik Yönetici  
*Technical Manager*





# TÜRK LOYDU

TL İş No : 9748  
TL Work No

## FABRİKA ÜRETİM KONTROL UYGUNLUK BELGESİ CERTIFICATE OF CONFORMITY OF THE FACTORY PRODUCTION CONTROL

<1785-CPR-0036>

Avrupa Parlamentosu ve Konseyinin 9 Mart 2011 tarihli 305/2011/AB Yapı Malzemeleri Yönetmeliği'ne uygun olarak bu sertifika aşağıdaki yapı malzemeleri için

*In compliance with Regulation 305/2011/EU of the European Parliament and of the Council of 9 March 2011 (the Construction Products Regulation or CPR), this certificate applies to the construction product*

### Yapısal amaçlı alüminyum ve alüminyum alaşımli ürünler Aluminium and aluminium alloy products for structural purposes

Ürün Product	Genel Hükümler General Conditions	Spesifik Şartlar Specific Conditions		Boyutlar Dimensions	Alaşım Alloys
		Mekanik Özellikler Mechanical Spec.	Toleranslar Tolerances		
Ekstrüzyonla İmalat Edilmiş Profil	EN 755-1	EN 755-2	EN 755-9	Çevre çapı 155 mm'den küçük ürünler ( $\geq \varnothing 155\text{mm}$ ) Products with circumference diameter less than 155 mm ( $\geq \varnothing 155\text{mm}$ )	EN AW 6060 EN AW 6063
Ekstrüzyonla İmalat Edilmiş Hassas Profil	EN 12020-1	EN 755-2	EN 12020-2	Çevre çapı 155 mm'den küçük ürünler ( $\geq \varnothing 155\text{mm}$ ) Products with circumference diameter less than 155 mm ( $\geq \varnothing 155\text{mm}$ )	

placed on the market under the name or trade mark of

**HİHAL ALÜMİNYUM İTHALAT VE İHRACAT SAN. VE TİC. LTD. ŞTİ.**

Hürriyet Mah. Dr. Cemil Bengü Cad. No 62 Kağıthane İSTANBUL

tarafından

and produced in the manufacturing plant (s)

**HİHAL ALÜMİNYUM İTHALAT VE İHRACAT SAN. VE TİC. LTD. ŞTİ.**

Edirne Org. San. Bölğ. 5. Cad. No:11-8, Domurcalı / Süloğlu / EDİRNE

tesisinde üretilmektedir.

Bu belge standardın Ek ZA'sında açıklanan performans süreklilik değerlendirme ve doğrulama ile ilgili tüm hükümlerin karşılandığını gösterir.

*This certificate attests that all provisions concerning the assessment and verification of constancy of performance described in Annex ZA of the standard(s)*

**EN 15088:2005**

Sistem 2+ uygulanmıştır ve  
under system 2+ is applied and that

fabrika üretim kontrolü yukarıda belirtilen tüm öngörülen şartları yerine getirmektedir.  
the factory production control fulfils all the prescribed requirements set out above.

Belgelendirme tarihi/Date of certification : 11.06.2018  
İlk Belgelendirme tarihi/Date of initial certification : 06.03.2015  
Belge geçerlilik tarihi/Date of certificate expiry : 05.03.2021

**Hasan MUFTUOĞLU**

Ürün Belgelendirme Komitesi Başkanı V.

Act. Head of Product Certification Committee

Yönetmeliğe uygun olarak ürünün sorumluluğu imalatçı veya yetkili temsilcisine aittir. Yönetmelikte belirtilen üretim/ürün değerlendirme sistemine tamamen uyulduğu zaman uygunluk işareti üzerine konulabilir ve uygunluk beyanı düzenlenebilir.  
Türk Loydu'nun herhangi bir ihmali dolayısıyla sebep olduğu kayıp ve hasarların ispatlanması durumunda, kayıplara "Mesleki Sorumluluk Sigortası" limitleri dahilinde tazminat ödenir.

*The product liability rests with the manufacturer or his representative in accordance with the directive. The conformity marking may only be affixed to the product and a Declaration of Conformity may only be issued when the production/product assessment system referred in the directive is fully complied with.  
If any person suffers loss or damage which is proved to have been caused by any negligent act or omission of Türk Loydu, that loss compensated within the limits of "Professional Indemnity Insurance".*

TÜRK LOYDU – Evliya Çelebi Mh. Tersaneler Cd. No.26/1 – 34944 Tuzla/İstanbul – Tel: 0216 581 37 00 – e-mail: endustri@turkloydu.org

# İÇİNDEKİLER INDEX



<b>ALDOKS SERİSİ</b> .....	<b>19</b>
<i>WINDOWS DOOR SYSTEM</i>	
<b>AHŞAP KASA PROFİLLERİ</b> .....	<b>41</b>
<i>WOODEN DOOR FRAME PROFILES</i>	
<b>ARA BÖLME PROFİLLERİ</b> .....	<b>51</b>
<i>PARTITION PROFILES</i>	
<b>HC60 SERİ</b> .....	<b>59</b>
<i>HC60 SERIE</i>	
<b>DAR TUBA SERİSİ</b> .....	<b>87</b>
<i>SLIDING WINDOWS SERIE</i>	
<b>GENİŞ TUBA SERİSİ</b> .....	<b>99</b>
<i>SLIDING WINDOWS SERIE</i>	
<b>VERANDA PROFİLLERİ</b> .....	<b>109</b>
<i>VERANDA PROFILES</i>	
<b>KOMPOZİT PROFİLLERİ</b> .....	<b>129</b>
<i>COMPOSITE PANEL PROFILES</i>	
<b>KÜPEŞTE PROFİLLERİ</b> .....	<b>137</b>
<i>HANDRAILS PROFILES</i>	
<b>KARE KÜPEŞTE PROFİLLERİ</b> .....	<b>181</b>
<i>SQUARE HANDRAILS PROFILES</i>	
<b>CAM KÜPEŞTE PROFİLLERİ</b> .....	<b>191</b>
<i>GLASS HANDRAILS PROFILES</i>	
<b>MOBİLYA PROFİLLERİ</b> .....	<b>197</b>
<i>FURNITURE PROFILES</i>	
<b>SERAMİK PROFİLLERİ</b> .....	<b>223</b>
<i>CERAMIC PROFILES</i>	
<b>TEMİZ ODA PROFİLLERİ</b> .....	<b>251</b>
<i>COOLING ROOM PROFILES</i>	
<b>VİTRİN PROFİLLERİ</b> .....	<b>259</b>
<i>SHOWCASE PROFILE</i>	
<b>GÜNEŞ KIRICI PROFİLLER</b> .....	<b>263</b>
<i>SUNBREAKER PROFILES</i>	
<b>ZEMİN PROFİLLERİ</b> .....	<b>269</b>
<i>FLOORING PROFILE</i>	
<b>PANJUR PROFİLLERİ</b> .....	<b>283</b>
<i>SHUTTER PROFILES</i>	
<b>DENİZLİK, SÜPÜRGELİK PROFİLLERİ</b> .....	<b>291</b>
<i>WINDOWSILL, SKIRTING PROFILES</i>	
<b>BORU PROFİLLERİ</b> .....	<b>297</b>
<i>PIPE PROFILES</i>	
<b>DİKDÖRTGEN VE KARE PROFİLLER</b> .....	<b>301</b>
<i>RECTANGULAR AND SQUARE PROFILES</i>	
<b>KÖŞEBENT, T, U VE LAMA PROFİLLERİ</b> .....	<b>305</b>
<i>KÖŞEBENT, T, U AND FLAT BAR PROFILES</i>	





## PROFİL KATALOĐU











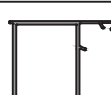

# ALDOKS SERİSİ

WINDOWS DOOR SYSTEM

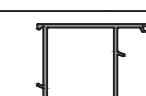
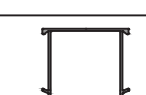

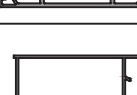

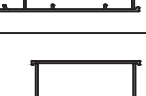



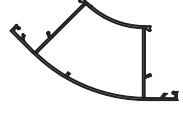
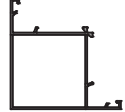

★ ProfİL Ađırlıkları Teorik Olup Teslim Anındaki Ađırlık Geerlidir

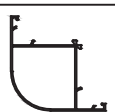
★ *Weight of profiles are theoretical, net weight will valid at the time of delivery.*





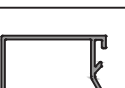

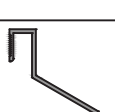

★ Yandaki profil birim ağırlıkları, bilgisayarda hesaplanmış teorik ağırlıklardır.

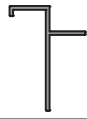
PROFİL KESİTİ	PROFİL KODU	PROFİL ADI	AĞIRLIK	ATALET MOMENTLERİ		SAYFA NO
				$J_x$ (cm <sup>4</sup> )	$J_y$ (cm <sup>4</sup> )	
	1339	Dar Kasa Profili	0,460 kg/m	5,38	1,88	
	1338	Dar Kanat Profili	0,549 kg/m	8,05	2,53	
	1340	Dar Orta Kayıt Profili	0,549 kg/m	6,05	3,99	
	1096	Kasa Profili	0,599 kg/m	8,60	5,58	
	2937	Kasa Profili	0,888 kg/m	11,47	8,09	
	1095	Kanat Profili	0,699 kg/m	13,42	6,10	
	2411	Kanat Profili	1,041 kg/m	18,20	8,80	
	1097	Orta Kayıt Profili	0,696 kg/m	10,48	8,44	
	2412	Orta Kayıt Profili	1,041 kg/m	14,12	12,26	
	2860	Geniş Kasa Profili	1,061 kg/m	33,19	13,67	
	2120	Geniş Kanat Profili	1,166 kg/m	44,27	14,45	
	2859	Geniş Orta Kayıt Profili	1,189 kg/m	43,58	15,81	
	2123	Takviyeli Kasa Profili	1,086 kg/m	34,34	14,41	
	2124	Takviyeli Kanat Profili	1,191 kg/m	34,37	16,37	













★ Yandaki profil birim ağırlıkları, bilgisayarda hesaplanmış teorik ağırlıklardır.

PROFİL KESİTİ	PROFİL KODU	PROFİL ADI	AĞIRLIK	ATALET MOMENTLERİ		SAYFA NO
				$J_x$ (cm <sup>4</sup> )	$J_y$ (cm <sup>4</sup> )	
	2121	Etek Profili	1,287 kg/m	63,94	18,08	
	4157	135° Dönüş Profili	0,974 kg/m	...	...	
	4158	90° Dönüş Profili	0,806 kg/m	...	...	
	4159	90° Dönüş Profili	1,520 kg/m	...	...	
	4160	90° Dönüş Profili	0,720 kg/m	...	...	
	4161	Tırnak Adaptörü	0,272 kg/m	...	...	
	4162	Düz Seri Çarpma Kapı Adaptörü	0,341 kg/m	...	...	
	4163	Düz Seri Çarpma Kapı Adaptörü	0,260 kg/m	...	...	
	1750	Cam Çıtası	0,215 kg/m	...	...	
	1090	Cam Çıtası	0,232 kg/m	...	...	
	1749	Tek Cam Çıtası	0,215 kg/m	...	...	
	2413	Tek Cam Çıtası	0,243 kg/m	...	...	
	1088	Tek Cam Çıtası	0,232 kg/m	...	...	
	1094	Damlalık	0,188 kg/m	...	...	

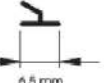

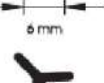

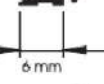
★ Yandaki profil birim ağırlıkları, bilgisayarda hesaplanmış teorik ağırlıklardır.

PROFİL KESİTİ	PROFİL KODU	PROFİL ADI	AĞIRLIK	ATALET MOMENTLERİ		SAYFA NO
				$J_x$ (cm <sup>4</sup> )	$J_y$ (cm <sup>4</sup> )	
	1404	Fugalı Te Bini	0,275 kg/m	...	...	
	1175	İspayolet Yuvası	0,135 kg/m	...	...	
	1176	Fugalı Te Bini	0,94 kg/m	...	...	
	1406	Dar U Bağlantı Profili	0,451 kg/m	...	...	
	1330	Geniş U Bağlantı Profili	0,627 kg/m	...	...	
	1114	Köşebent	0,823 kg/m	...	...	
	1333	Köşe Takozu	0,772 kg/m	...	...	
	1099	Köşe Takozu	1,122 kg/m	...	...	

★ Yandaki profil ağırlıkları, bilgisayarda hesaplanmış teorik ağırlıklardır.

AKSESUAR KESİTİ	AKSESUAR KODU	AKSESUAR ADI	AĞIRLIK	PAKETLEME	SAYFA NO
 <b>HA57-01</b> CAM FİTİLİ 1 Pk 100mt 6,10kg GLASS GASKET	HA57-01	Cam Fiteli	6,10 kg	1 Pk/ 100mt	
 <b>HA57-02</b> CAM FİTİLİ 1 Pk 100mt 7,85kg GLASS GASKET	HA57-02	Cam Fiteli	7,85 kg	1 Pk/ 100mt	
 <b>HA57-03</b> CAM FİTİLİ 1 Pk 100mt 8,80kg GLASS GASKET	HA57-03	Cam Fiteli	8,80 kg	1 Pk/ 100mt	
 <b>HA57-04</b> OMEGA FİTİLİ 1 Pk 100mt 2,6kg OMEGA GASKET	HA57-04	Omega Fiteli	2,60 kg	1 Pk/ 100mt	
 <b>HA57-05</b> OMEGA FİTİLİ 1 Pk 100mt 2,8kg OMEGA GASKET	HA57-05	Omega Fiteli	2,80 kg	1 Pk/ 100mt	
	HA59-06/1/1 HA59-06/1/2	Çakma Fitel	3,30 kg	1 Pk/ 100mt	
	HA59-06/1/3 HA59-06/1/4	Çakma Fitel	3,80 kg	1 Pk/ 100mt	
	HA57-15	Aldoks Fitel	1,80 kg ...	1 Pk/ 100mt	
	HA57-16	Aldoks Fitel	2,10 kg	1 Pk/ 100mt	
	HA57-18	Aldoks Çift Kulak Fitel	2,60 kg	1 Pk/ 100mt	
	HA57-19	Aldoks Çift Kulak Fitel	2,80 kg	1 Pk/ 100mt	
	HA57-22	Maçalı Fitel	2,30 kg	1 Pk/ 100mt	
	HA57-23	Maçalı Fitel	2,80 kg	1 Pk/ 100mt	
	HA57-24	Maçalı Fitel	3,20 kg	1 Pk/ 100mt	

★ Yandaki profil birim ağırlıkları, bilgisayarla hesaplanmış teorik ağırlıklardır.

AKSESUAR KESİTİ	AKSESUAR KODU	AKSESUAR ADI	AĞIRLIK	PAKETLEME	SAYFA NO
 <b>HA32-15/1/8</b> ALDOKS MENTEŞE DÜZ KULLANIM: 100 KULLANIM: 100 KULLANIM: 100	HA32-15/1/8	Aldoks Menteşe Düz	...	240 Ad/ 1 Paket	
 <b>HA32-15/2/7</b> ALDOKS MENTEŞE FUGALI KULLANIM: 100 KULLANIM: 100 KULLANIM: 100	HA32-15/2/7	Aldoks Menteşe Fugalı	...	240 Ad/ 1 Paket	
 <b>HA32-08/5</b> İSPANYOLET KOL - PARMAK İZLİ ÇATALLI KULLANIM: 100 KULLANIM: 100 KULLANIM: 100	HA32-08/5	İspanyolet Kol Parmak İzli Çatallı	...	120 Ad/ 1 Paket	
 <b>HA31-01</b> YAYLI SOSİS KOL KULLANIM: 100 KULLANIM: 100 KULLANIM: 100	HA31-01	Yaylı Sosis Kol	...	50 Ad/ 1 Paket	
 <b>HA31-09/2</b> GENİŞ AYNALI SOSİS KOL KULLANIM: 100 KULLANIM: 100 KULLANIM: 100	HA31-09/2	Geniş Aynalı Sosis Kol	...	25 Ad/ 1 Paket	
 <b>HA31-11</b> KIVRIK BORU KOL KULLANIM: 100 KULLANIM: 100 KULLANIM: 100	HA31-11	Kıvrık Boru Kol	...		
 <b>HA31-28</b> BANT LAMA KOL KULLANIM: 100 KULLANIM: 100 KULLANIM: 100	HA31-28	Bant Lama Kol	...		
 <b>HA31-16</b> YARIM AY DÖKÜM KOL KULLANIM: 100 KULLANIM: 100 KULLANIM: 100	HA31-16	Yarım Ay Döküm Kol	...	30 Ad/ 1 Paket	
 <b>HA32-16/2</b> DÜZ ALDOKS GEÇME MENTEŞE KULLANIM: 100 KULLANIM: 100 KULLANIM: 100	HA32-16/2	Düz Aldoks Geçme Menteşe	...	240 Ad/ 1 Paket	
 <b>HA32-19/3-4E</b> ÜSTTEN MONTELİ MENTEŞE KULLANIM: 100 KULLANIM: 100 KULLANIM: 100	HA32-19/3-4E	Üstten Monteli Menteşe	...	250 Ad/ 1 Paket	
 <b>HA33-05/1</b> ALDOKS DİLLİ KİLİT KARŞILIĞI KULLANIM: 100 KULLANIM: 100 KULLANIM: 100	HA32-05/1	Aldoks Dilli Kilit Karşılığı	...	550 Ad/ 1 Paket	
 <b>HA33-05/2</b> ALDOKS MAKARALI KİLİT KARŞILIĞI KULLANIM: 100 KULLANIM: 100 KULLANIM: 100	HA33-05/1	Aldoks Makaralı Kilit Karşılığı	...	550 Ad/ 1 Paket	
 <b>HA33-04/2</b> ALÜMİNYUM KAPI ALTI FIRÇASI KULLANIM: 100 KULLANIM: 100 KULLANIM: 100	HA33-04/2	Alüminyum Kapı Altı Fırçası	...	100 Ad/ 1 Paket	
 <b>HA32-34/1</b> ALDOKS PİM TAKIMI KULLANIM: 100 KULLANIM: 100 KULLANIM: 100	HA32-34/1	Aldoks Pim Takımı	...	100 Ad/ 1 Paket	

★ Yandaki profil birim ağırlıkları, bilgisayarda hesaplanmış teorik ağırlıklardır.

AKSESUAR KESİTİ	AKSESUAR KODU	AKSESUAR ADI	AĞIRLIK	PAKETLEME	SAYFA NO
 <b>HA32-31</b> ALÜMİNYUM İSPANYOLET Tij Çubuğu KİLİT ADI: 3001 KİLİT ADI: 3002 KİLİT ADI: 3003 KİLİT ADI: 3004	HA32-31	Alüminyum İspanyolet Tij Çubuğu	...	100 Ad/ 1 Paket	
 <b>HA31-26</b> SAPLAMA TAKIMI 1 Pk. 50 Tl. 0,90 kg RUT KIT	HA31-26	Saplama Takımı	...	50 Ad/ 1 Paket	
 <b>HA33-08/2-1</b> 80 MİLLİTİM VASİSTAS MAKAS 13CM KİLİT ADI: 3001 KİLİT ADI: 3002 KİLİT ADI: 3003 KİLİT ADI: 3004	HA33-08/2	Aldoks Vasistas Makas 13 cm	...	700 Ad/ 1 Paket	
 <b>HA33-08/1-3</b> 80 MİLLİTİM VASİSTAS MAKAS 22CM KİLİT ADI: 3001 KİLİT ADI: 3002 KİLİT ADI: 3003 KİLİT ADI: 3004	HA33-08/1	Aldoks Vasistas Makas 22 cm	...	500 Ad/ 1 Paket	
 <b>HA33-16</b> GÖMME SÜRGÜ KİLİT ADI: 3001 KİLİT ADI: 3002 KİLİT ADI: 3003 KİLİT ADI: 3004	HA33-16	Gömme Sürgü	...	500 Ad/ 1 Paket	
 <b>HA32-27/1</b> BAŞ GENİŞ ORTA KAYIT BAĞLANTI 1 Pk. 100 Ad. 0,10 kg METAL LARGE PULLDOWN CONNECTOR	HA32-27/1	Saç Geniş Orta Kayıt Bağlantı	...	100 Ad/ 1 Paket	
 <b>HA32-28/2</b> SAÇ ALYAN BAĞLANTI 1 Pk. 250 Ad. 0,10 kg METAL ALYAN CONNECTOR	HA32-28/2	Saç Alyan Bağlantı	...	250 Ad/ 1 Paket	
	HA34-04-N	153 20 mm 62 mm Barelli Nikel Kilit	...	30 Ad/ 1 Paket	
	HA35-15/1	269 WC 20 mm Aldoks Kilit Barelsiz Nikel	...	40 Ad/ 1 Paket	
	HA34-01/2/2	68 mm Cerman Mandallı Nikel Barel	...	12 Ad/ 1 Paket	
 <b>HA32-22/3</b> ALDOKS BABA MENTEŞE KİLİT ADI: 3001 KİLİT ADI: 3002 KİLİT ADI: 3003 KİLİT ADI: 3004	HA32-22/3	Aldoks Baba Menteşe	...	120 Ad/ 1 Paket	
	HA33-15	Aldoks Vasistas Çarpma	...	500 Ad/ 1 Paket	
	HA31-25	Kare Kol	...	180 Ad/ 1 Paket	
	HA31-21	D Kol	...	40 Ad/ 1 Paket	

★ Yandaki profil birim ağırlıkları, bilgisayarla hesaplanmış teorik ağırlıklardır.

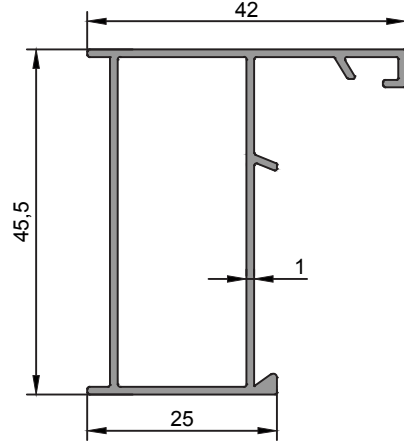

<b>1339</b>
Dar Kasa Profili
0,460 kg/m
$J_x=5,38 \text{ cm}^4$ $J_y=1,88 \text{ cm}^4$

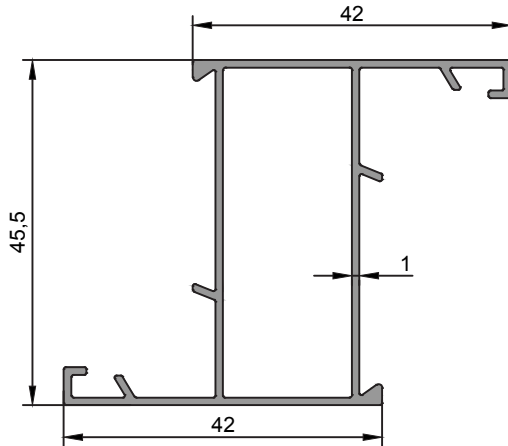

<b>1338</b>
Dar Kanat Profili
0,549 kg/m
$J_x=8,05 \text{ cm}^4$ $J_y=2,53 \text{ cm}^4$



★ Yandaki profil birim ağırlıkları, bilgisayarla hesaplanmış teorik ağırlıklardır.

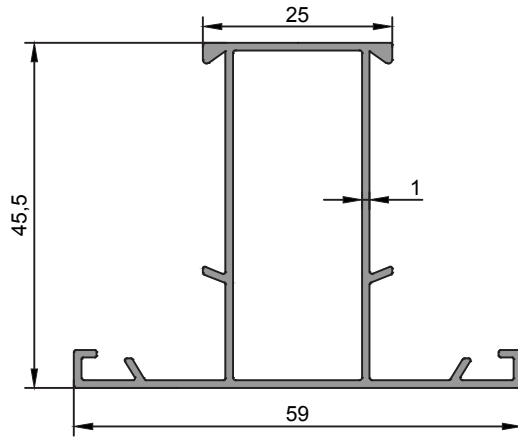

<b>1340</b>
Dar Orta Kayıt Profili
0,549 kg/m
$Jx=6,05 \text{ cm}^4$ $Jy=3,99 \text{ cm}^4$

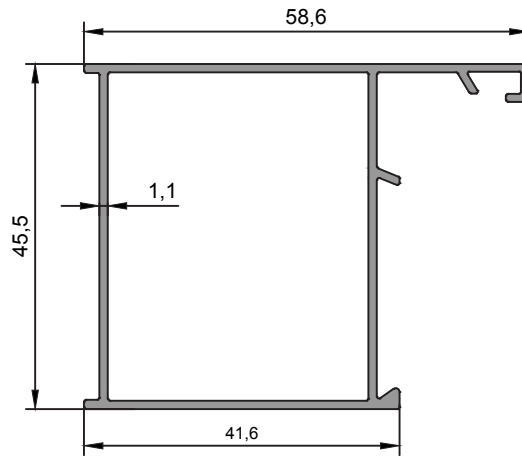

<b>1096</b>
Kasa Profili
0,599 kg/m
$Jx=8,60 \text{ cm}^4$ $Jy=5,58 \text{ cm}^4$

★ Yandaki profil birim ağırlıkları, bilgisayarla hesaplanmış teorik ağırlıklardır.

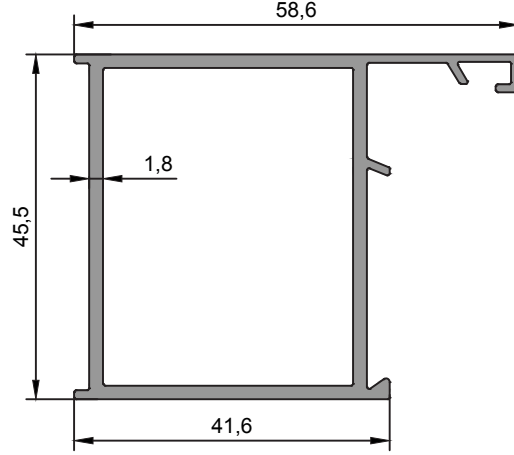

<b>2937</b>
Kasa Profili
0,888 kg/m
Jx=11,47 cm <sup>4</sup> Jy=8,09 cm <sup>4</sup>

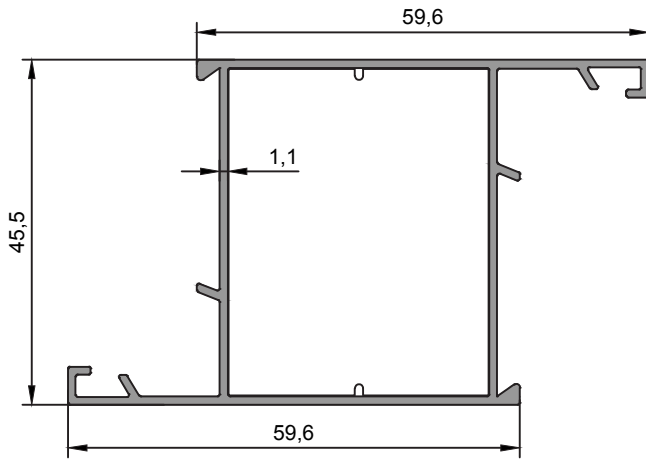

<b>1095</b>
Kanat Profili
0,699 kg/m
Jx=13,42 cm <sup>4</sup> Jy=6,10 cm <sup>4</sup>

★ Yandaki profil birim ağırlıkları, bilgisayarla hesaplanmış teorik ağırlıklardır.

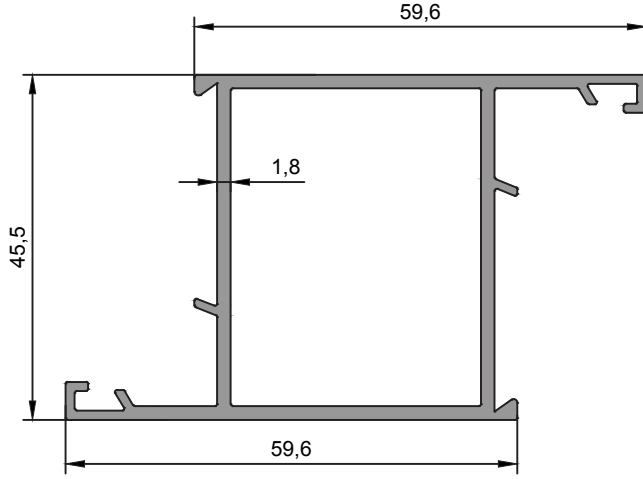

<b>2411</b>
Kanat Profili
1,041 kg/m
$Jx=18,20 \text{ cm}^4$ $Jy=8,80 \text{ cm}^4$

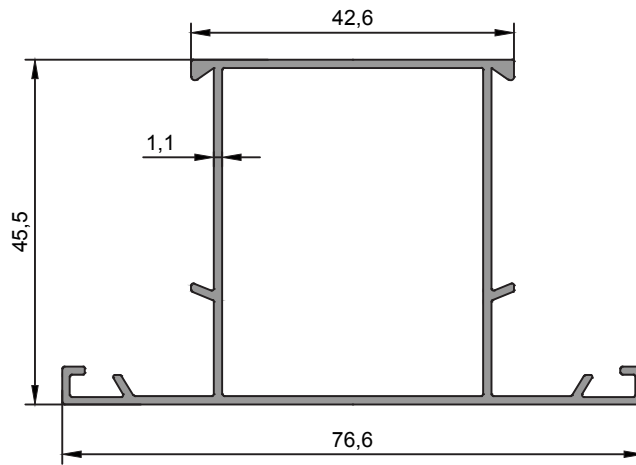

<b>1097</b>
Orta Kayıt Profili
0,696 kg/m
$Jx=10,48 \text{ cm}^4$ $Jy=8,44 \text{ cm}^4$

★ Yandaki profil birim ağırlıkları, bilgisayarla hesaplanmış teorik ağırlıklardır.

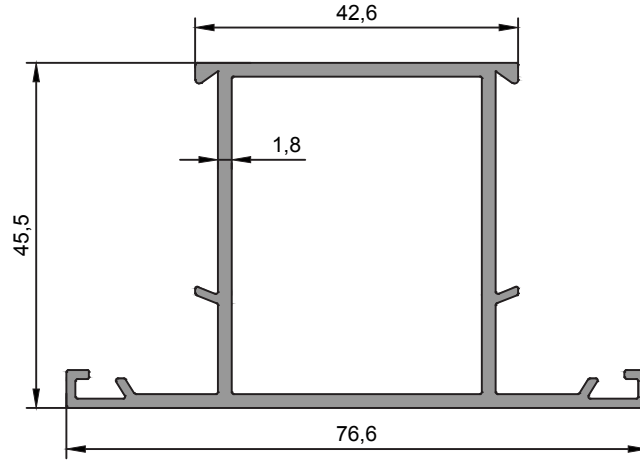

<b>2412</b>
Orta Kayıt Profili
1,041 kg/m
Jx=14,12 cm <sup>4</sup> Jy=12,26 cm <sup>4</sup>

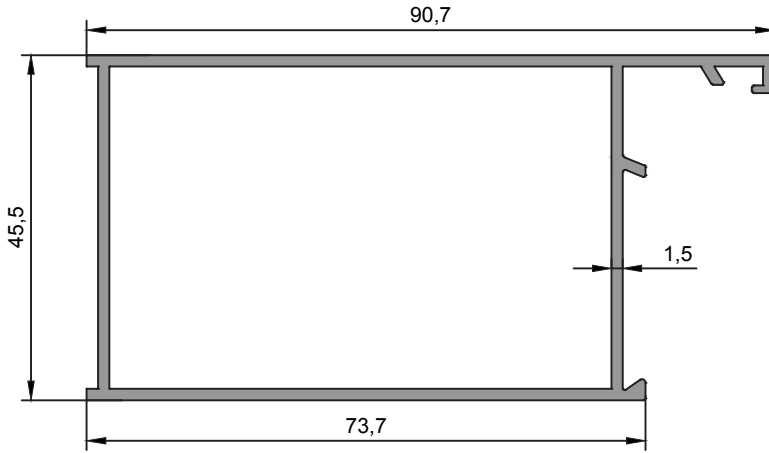

<b>2860</b>
Geniş Kasa Profili
1,061 kg/m
Jx=33,19 cm <sup>4</sup> Jy=13,67 cm <sup>4</sup>

★ Yandaki profil birim ağırlıkları, bilgisayarla hesaplanmış teorik ağırlıklardır.

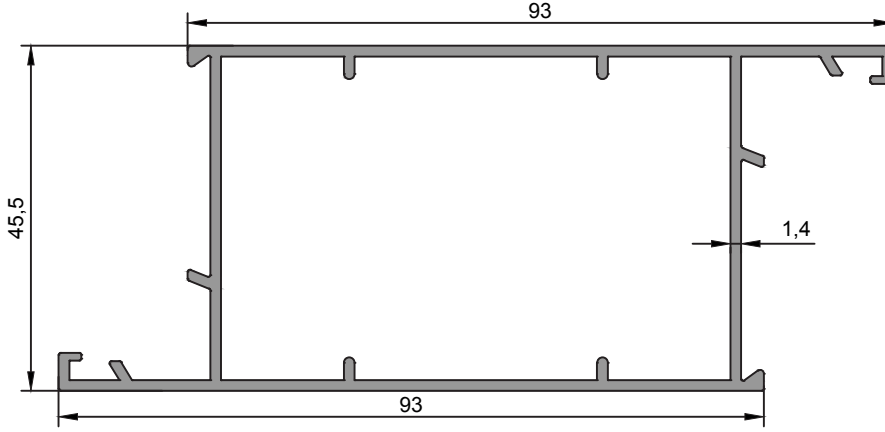

<b>2120</b>
Geniş Kanat Profili
1,166 kg/m
$Jx=44,27 \text{ cm}^4$ $Jy=14,45 \text{ cm}^4$

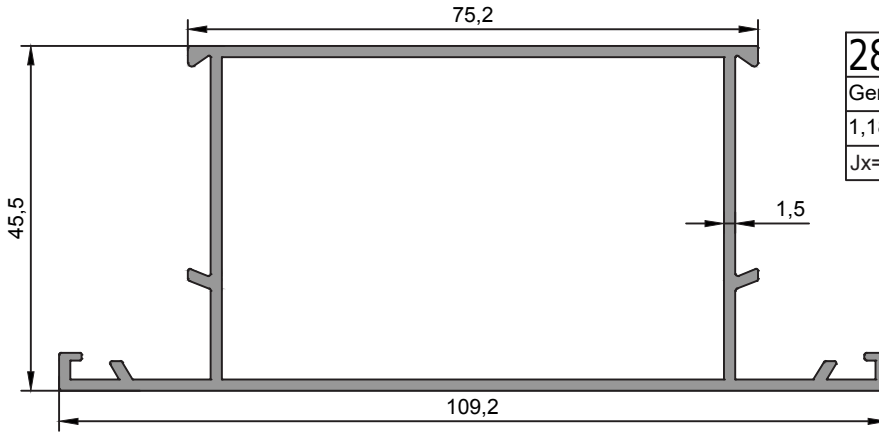

<b>2859</b>
Geniş Orta Kayıt Profili
1,189 kg/m
$Jx=43,58 \text{ cm}^4$ $Jy=15,81 \text{ cm}^4$

★ Yandaki profil birim ağırlıkları, bilgisayarda hesaplanmış teorik ağırlıklardır.

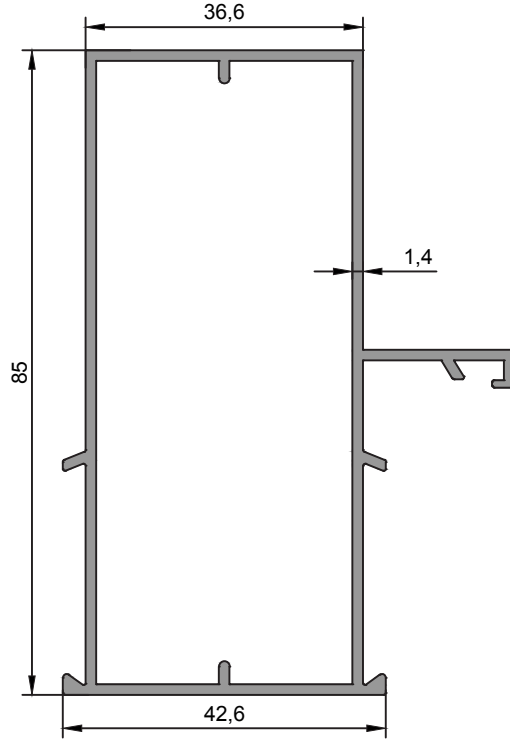

<b>2123</b>
Takviyeli Kasa Profili
1,086 kg/m
Jx=34,34 cm <sup>4</sup> Jy=14,41 cm <sup>4</sup>

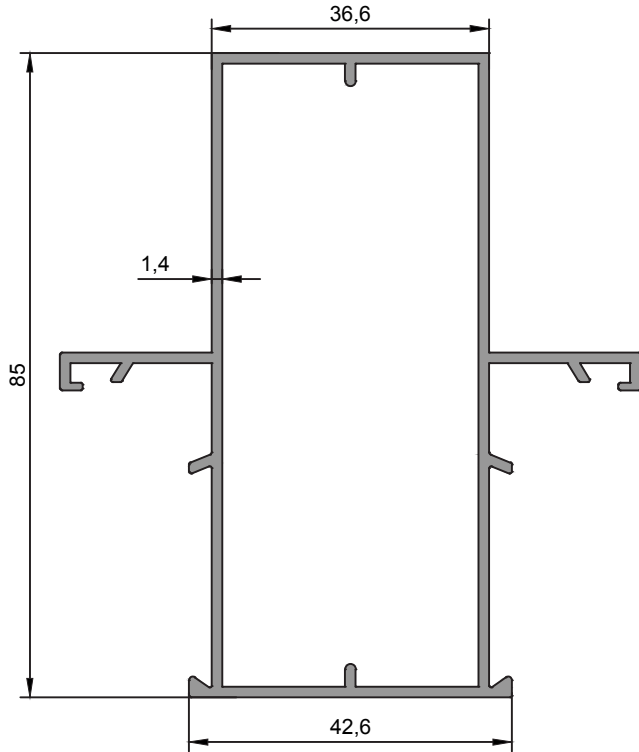

<b>2124</b>
Takviyeli Kanat Profili
1,191 kg/m
Jx=34,37 cm <sup>4</sup> Jy=16,37 cm <sup>4</sup>

<b>2121</b>
Etek Profili
1,287 kg/m
Jx=63,94 cm <sup>4</sup> Jy=18,08 cm <sup>4</sup>

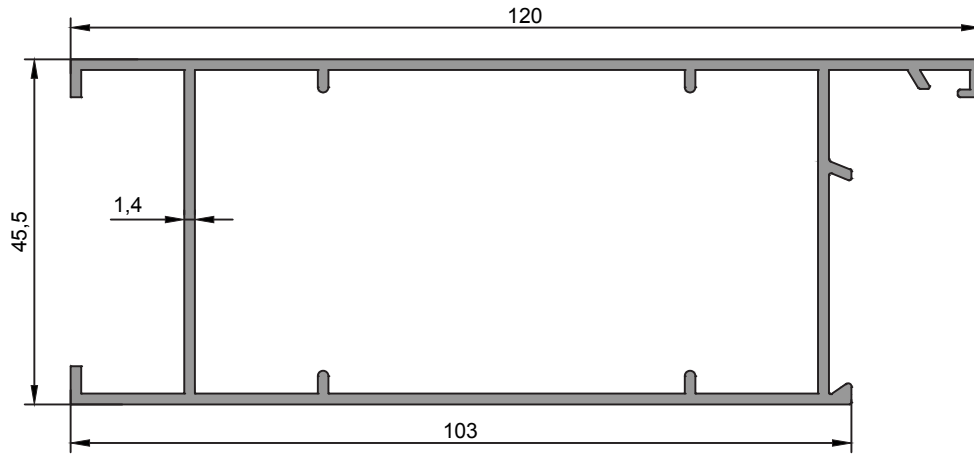

★ Yandaki profil birim ağırlıkları, bilgisayarla hesaplanmış teorik ağırlıklardır.

★ Yandaki profil birim ağırlıkları, bilgisayarda hesaplanmış teorik ağırlıklardır.

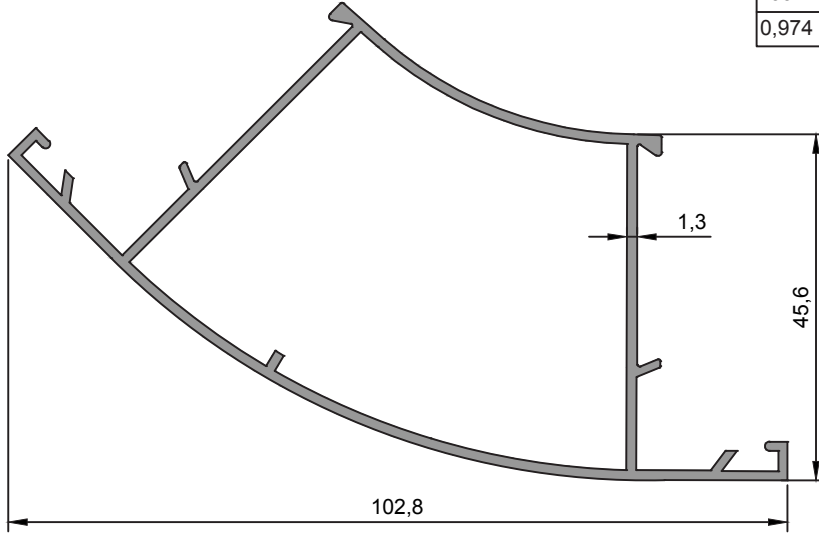

<b>4157</b>
135° Dönüş Profili
0,974 kg/m

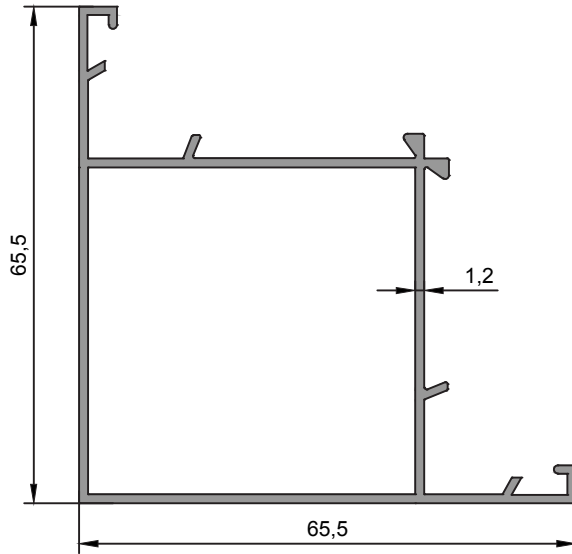

<b>4158</b>
90° Dönüş Profili
0,806 kg/m



★ Yandaki profil birim ağırlıkları, bilgisayarda hesaplanmış teorik ağırlıklardır.

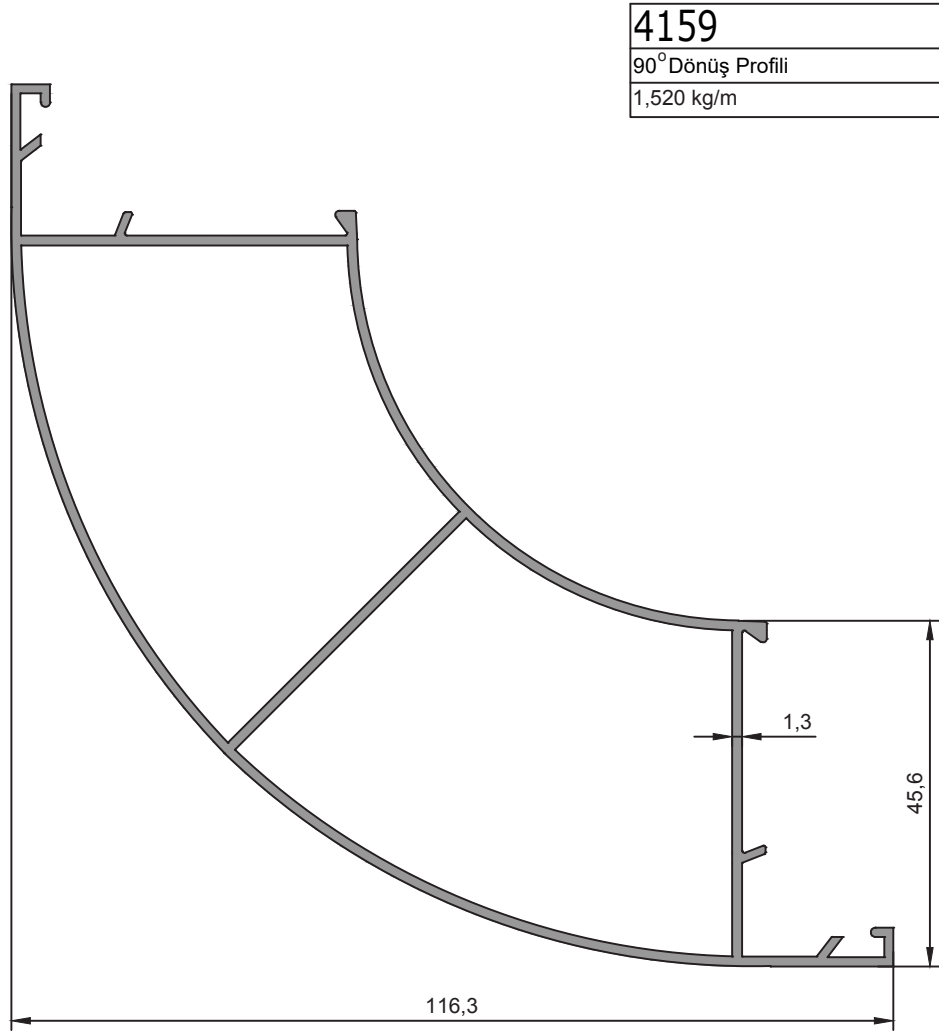

★ Yandaki profil birim ağırlıkları, bilgisayarda hesaplanmış teorik ağırlıklardır.

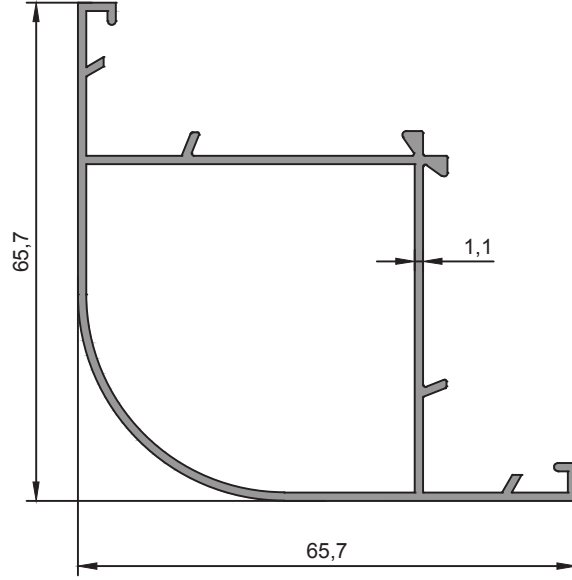

<b>4160</b>
90° Dönüş Profili
0,720 kg/m

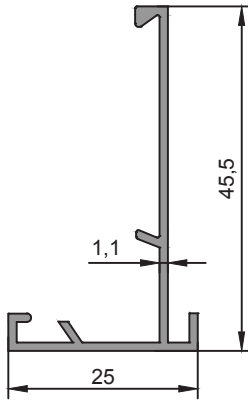

<b>4161</b>
Tırnak Adaptörü
0,272 kg/m

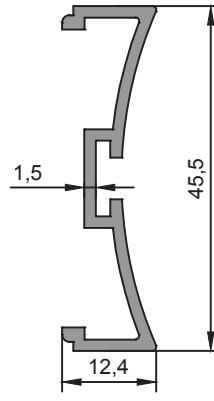

<b>4162</b>
Düz Seri Çarpma Kapı Adaptörü
0,341 kg/m

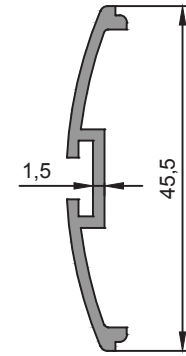

<b>4163</b>
Düz Seri Çarpma Kapı Adaptörü
0,260 kg/m

★ Yandaki profil birim ağırlıkları, bilgisayarla hesaplanmış teorik ağırlıklardır.

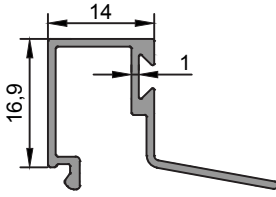

<b>1750</b>
Cam Çıtası
0,215 kg/m

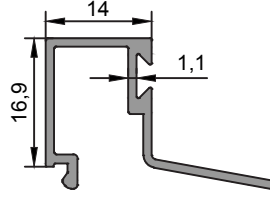

<b>1090</b>
Cam Çıtası
0,232 kg/m

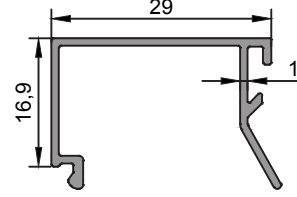

<b>1749</b>
Tek Cam Çıtası
0,215 kg/m

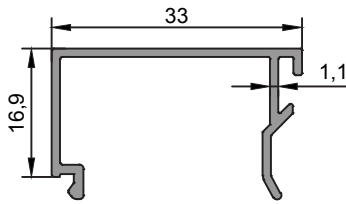

<b>2413</b>
Tek Cam Çıtası
0,243 kg/m

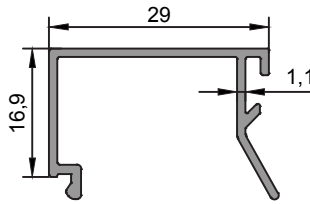

<b>1088</b>
Tek Cam Çıtası
0,232 kg/m

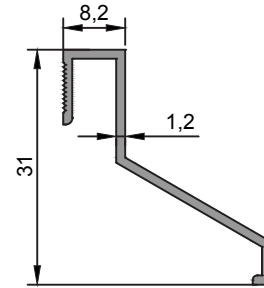

<b>1094</b>
Fugalı Te Bini
0,188 kg/m

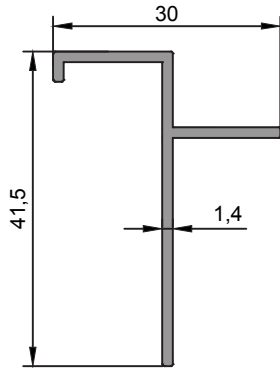

<b>1404</b>
Fugalı Te Bini
0,275 kg/m

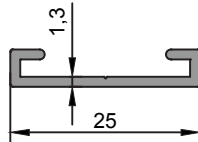

<b>1175</b>
İspanyolet Yuvası
0,135 kg/m

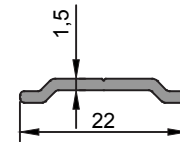

<b>1176</b>
İspanyolet Çubuğu
0,94 kg/m

★ Yandaki profil birim ağırlıkları, bilgisayarla hesaplanmış teorik ağırlıklardır.

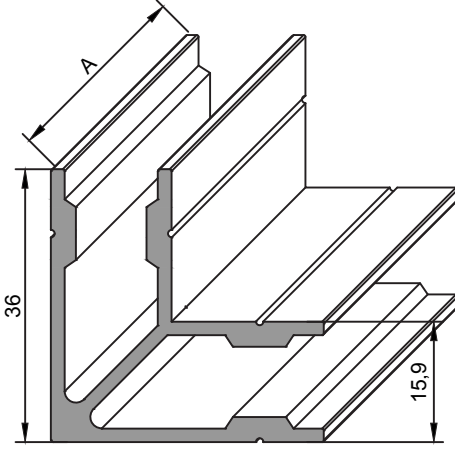

<b>1333</b>
Köşe Tako
0,772 kg/m

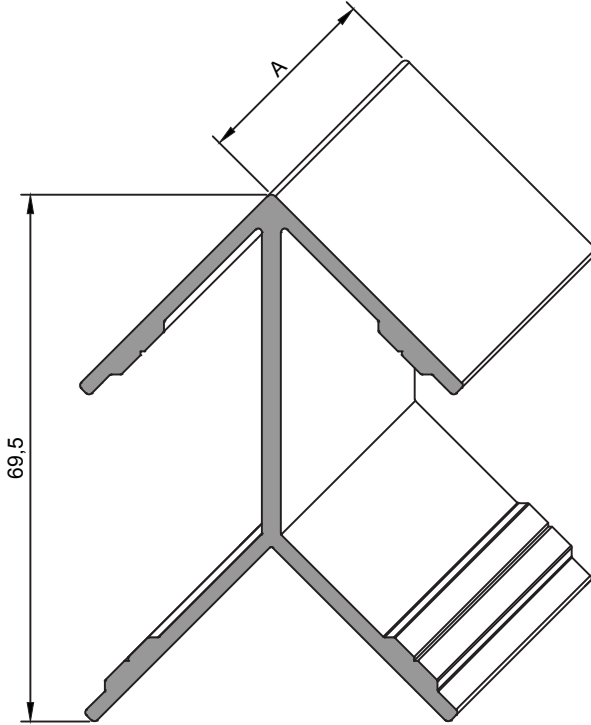

<b>1099</b>
Köşe Tako
1,122 kg/m

★ Yandaki profil birim ağırlıkları, bilgisayarda hesaplanmış teorik ağırlıklardır.

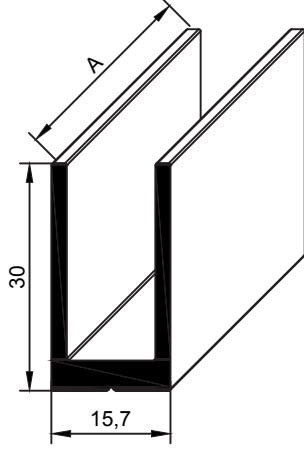

<b>1406</b>
Dar U Bağlantı Profili
0,451 kg/m

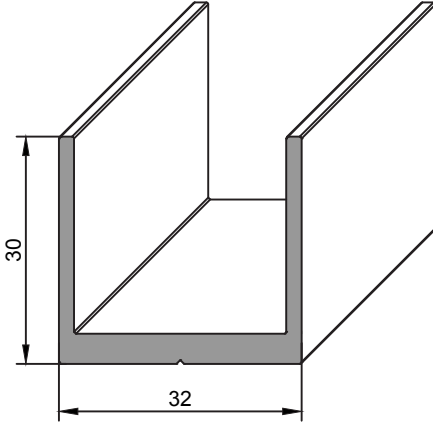

<b>1330</b>
Geniş U Bağlantı Profili
0,627 kg/m

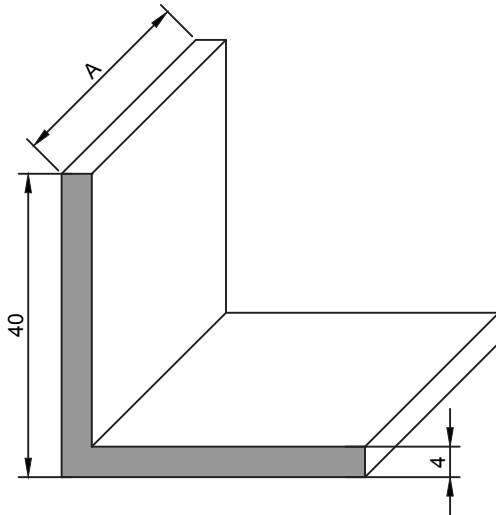

<b>1114</b>
Köşebent
0,823 kg/m





## PROFİL KATALOĐU







# AHŐAP KASA PROFİLLERİ

WOODEN DOOR FRAME PROFILES

★ Profil Ađırlıkları Teorik Olup Teslim Anındaki Ađırlık Geerlidir

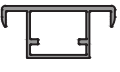
★ *Weight of profiles are theoretical, net weight will valid at the time of delivery.*

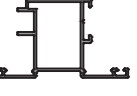
★ Yandaki profil birim ağırlıkları, bilgisayarda hesaplanmış teorik ağırlıklardır.

PROFİL KESİTİ	PROFİL KODU	PROFİL ADI	AĞIRLIK	ATALET MOMENTLERİ		SAYFA NO
				$J_x$ (cm <sup>4</sup> )	$J_y$ (cm <sup>4</sup> )	
	3270	İç Kasa Profili	1,300 kg/m	51,40	5,00	
	3271	Dış Kasa Profili	1,062 kg/m	35,41	7,02	
	3162	Lambiri	0,455 kg/m	4,02	0,57	
	3163	Kapı Kenarı Profili	0,497 kg/m	2,80	0,96	
	2941	Dış Kasa Profili	1,110 kg/m	39,23	9,79	
	2940	İç Kasa Profili	1,529 kg/m	43,08	9,80	
	3289	Çift Kanat Adaptörü	0,883 kg/m	11,08	7,83	
	2942	Alt Etek Profili	0,959 kg/m	10,64	2,25	
	2943	Kapı Profili	0,918 kg/m	10,23	2,71	



AKSESUAR KESİTİ	AKSESUAR KODU	AKSESUAR ADI	AĞIRLIK	PAKETLEME	SAYFA NO
	HL37	Kanal Dolgu Fiteli	107 gr/m	15 kg/ 140 m	
	HA32-30/1/2	10x19 mm Zamak Köşe	...	1 Ad/ Paket	
	HA32-30/2/2	10x24 mm Zamak Köşe	...	1 Ad/ Paket	
	HA32-26/5	Panel Menteşe	...	1 Ad/ Paket	
	HA-32-26/5-1	Kelebek Menteşe	...	1 Ad/ Paket	
	152RP45	Kapı Kiliti	...	1 Ad/ Paket	
	HA31-07/G63-1	Paslanmaz Yuvarlak Rozetli Sosis Kol	...	1 Ad/ Paket	
	HA31-07/G63	Paslanmaz Yuvarlak Rozetli Sosis Kol(WC İçin)	...	1 Ad/ Paket	
	HA39-04	Pervaz Köşesi L İnce Onbaşı	...	...	

★ Yandaki profil birim ağırlıkları, bilgisayarda hesaplanmış teorik ağırlıklardır.

★ Yandaki profil birim ağırlıkları, bilgisayarla hesaplanmış teorik ağırlıklardır.

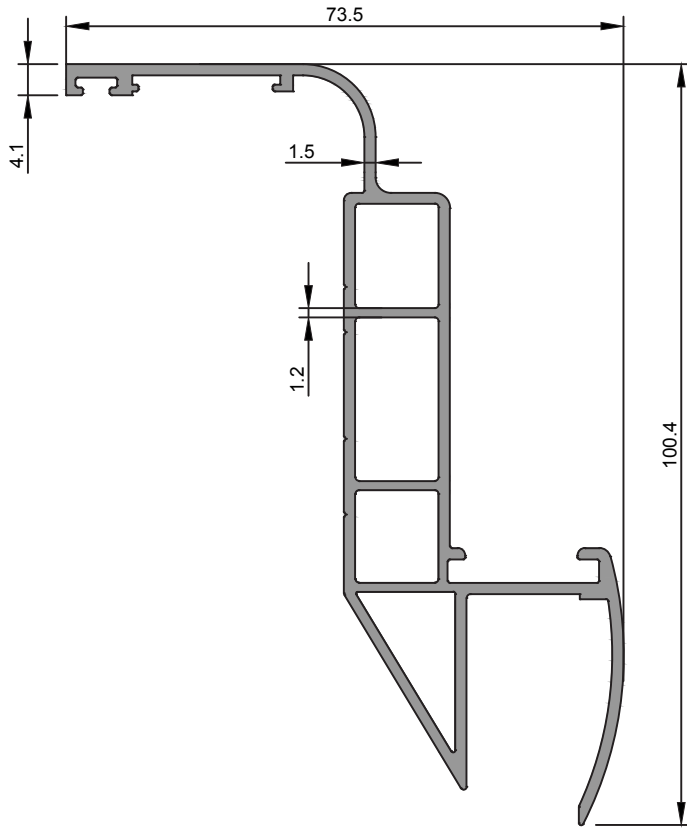

<b>3270</b>
İç Kasa
1,300 kg/m
$J_x=51,40 \text{ cm}^4$ $J_y=5,00 \text{ cm}^4$

★ Yandaki profil birim ağırlıkları, bilgisayarla hesaplanmış teorik ağırlıklardır.

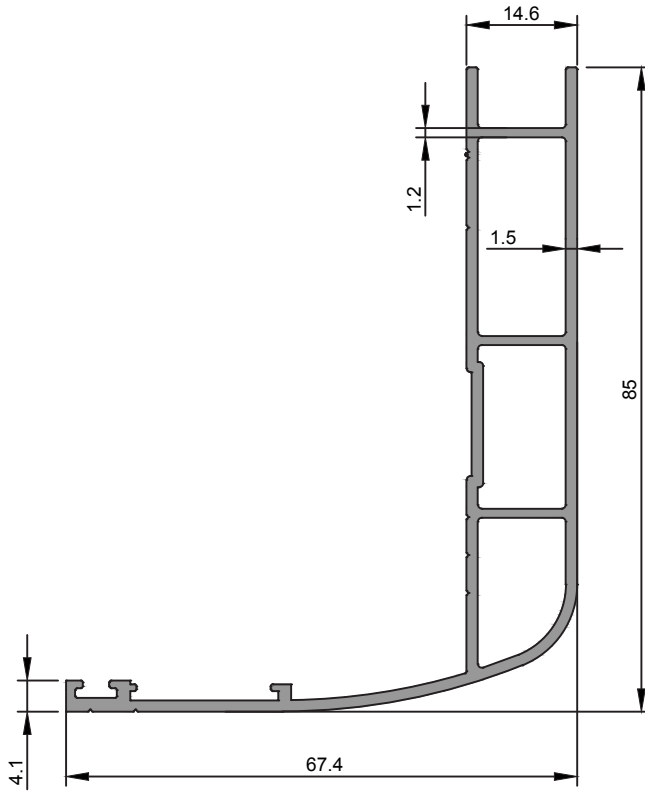

<b>3271</b>
Dış Kasa
1,062 kg/m
$J_x=35,41 \text{ cm}^4$ $J_y=7,02 \text{ cm}^4$

★ Yandaki profil birim ağırlıkları, bilgisayarla hesaplanmış teorik ağırlıklardır.

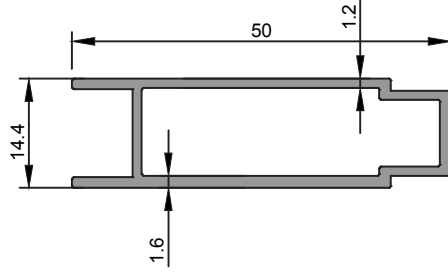

<b>3162</b>
Lambiri
0,455 kg/m
$J_x=4,02 \text{ cm}^4$ $J_y=0,57 \text{ cm}^4$

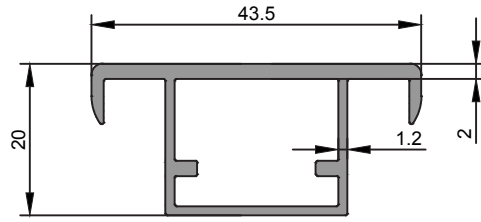

<b>3163</b>
Kapı Kenarı
0,497 kg/m
$J_x=2,80 \text{ cm}^4$ $J_y=0,96 \text{ cm}^4$

★ Yandaki profil birim ağırlıkları, bilgisayarla hesaplanmış teorik ağırlıklardır.

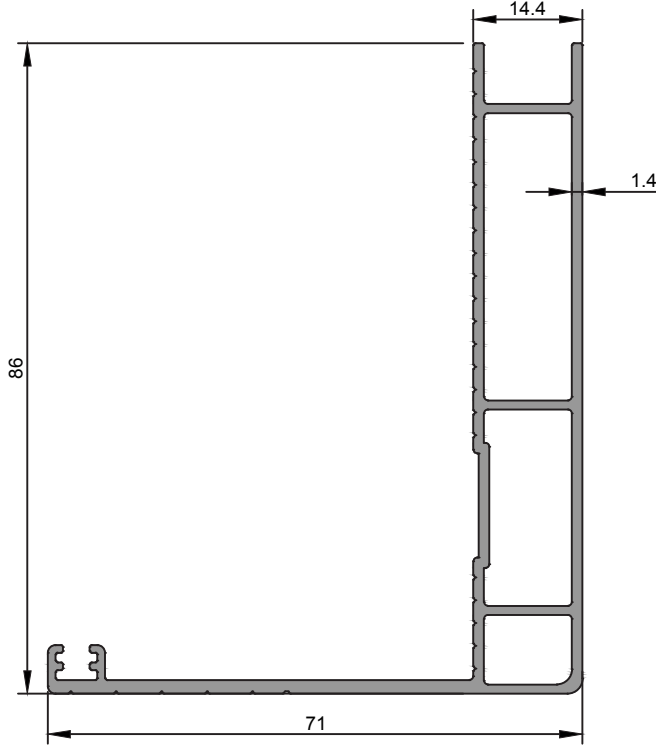

<b>2941</b>
Dış Kasa
1,110 kg/m
$J_x=39,23 \text{ cm}^4$ $J_y=9,79 \text{ cm}^4$

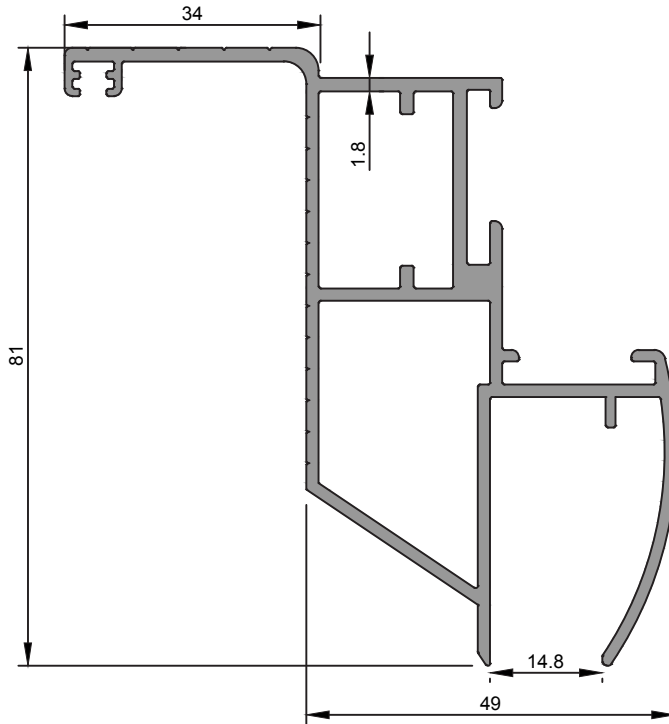

<b>2940</b>
İç Kasa
1,529 kg/m
$J_x=43,08 \text{ cm}^4$ $J_y=9,80 \text{ cm}^4$

★ Yandaki profil birim ağırlıkları, bilgisayarla hesaplanmış teorik ağırlıklardır.

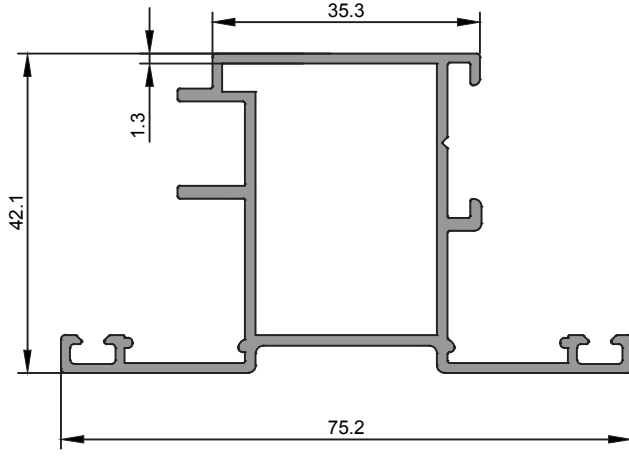

<b>3289</b>
Çift Kanat Adaptörü
0,883 kg/m
Jx=11,08 cm <sup>4</sup> Jy=7,83 cm <sup>4</sup>

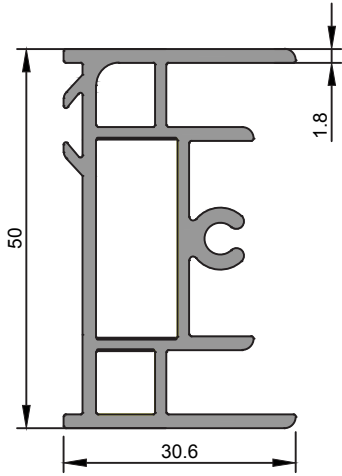

<b>2942</b>
Alt Etek
0,959 kg/m
Jx=10,64 cm <sup>4</sup> Jy=2,25 cm <sup>4</sup>

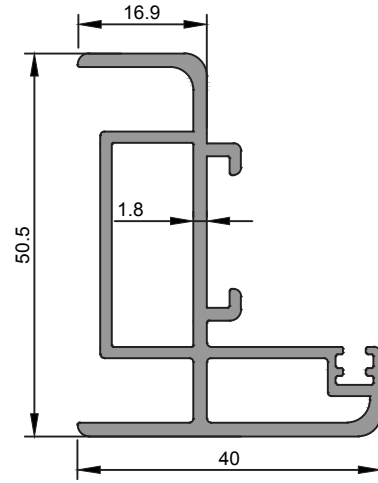

<b>2943</b>
Kapı Profili
0,918 kg/m
Jx=10,23 cm <sup>4</sup> Jy=2,71 cm <sup>4</sup>

★ Yandaki profil birim ağırlıkları, bilgisayarla hesaplanmış teorik ağırlıklardır.

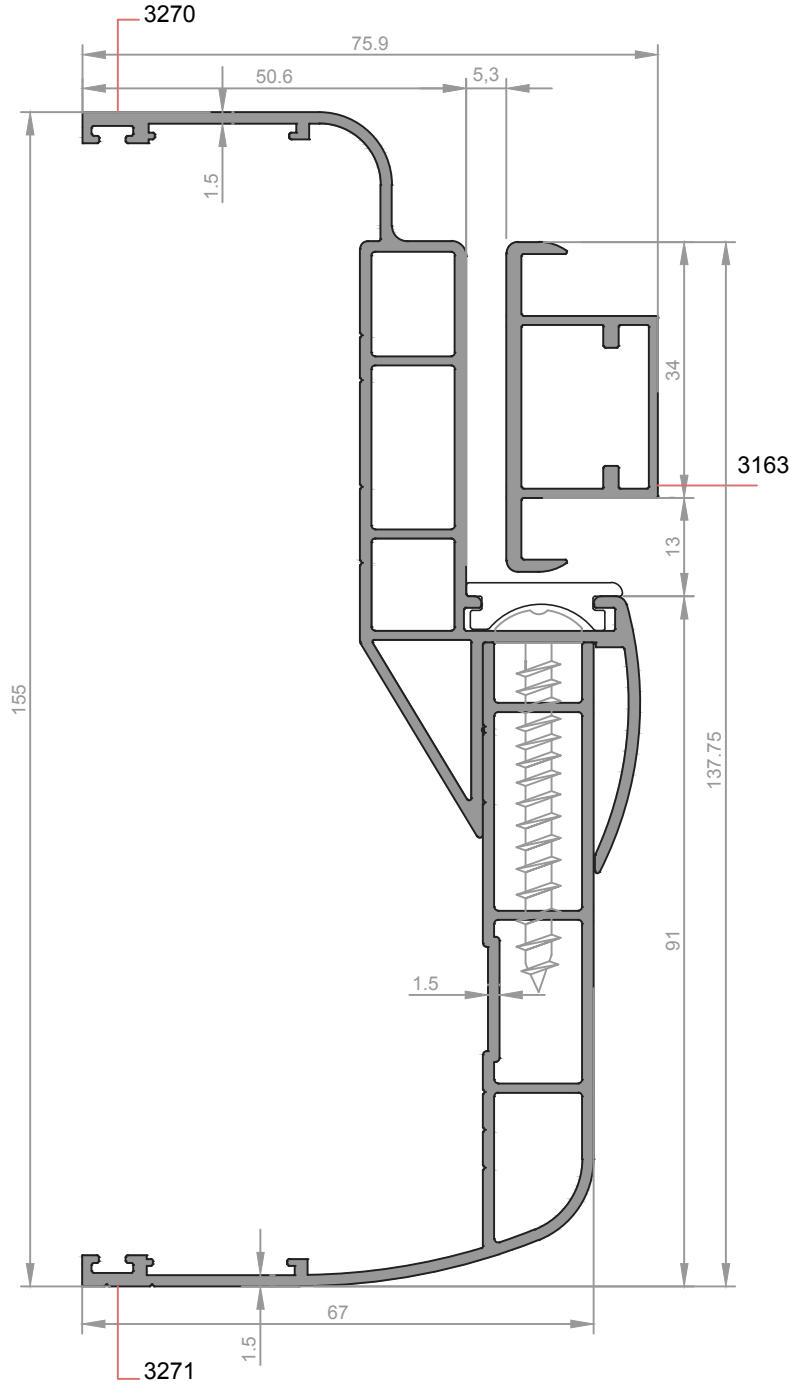

★ Yandaki profil birim ağırlıkları, bilgisayarla hesaplanmış teorik ağırlıklardır.

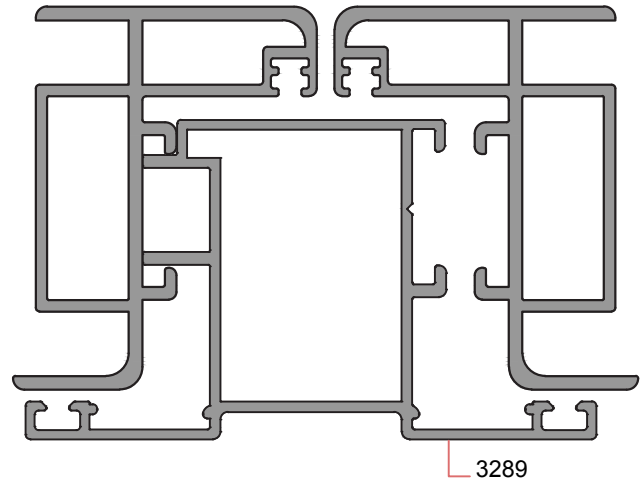
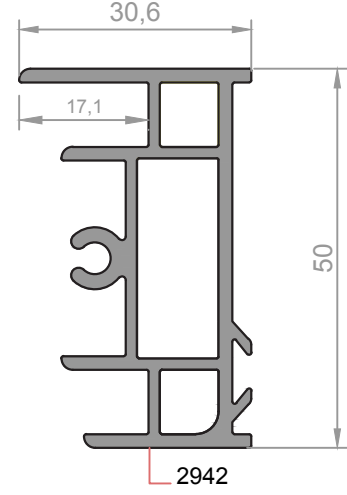
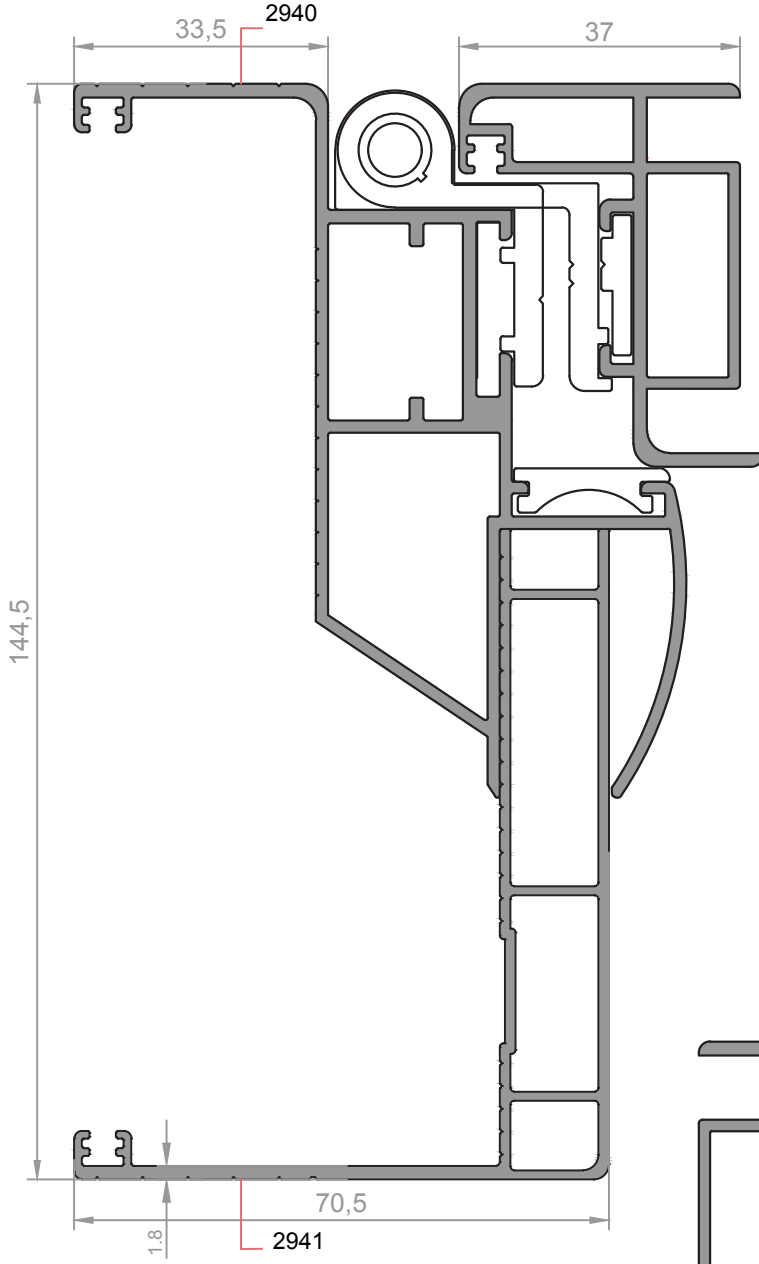





**PROFİL** KATALOĐU









# **ARA BÖLME PROFİLLERİ**

*PARTITION PROFILES*

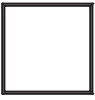
★ Profil Ağırlıkları Teorik Olup Teslim Anındaki Ağırlık Geçerlidir

★ *Weight of profiles are theoretical, net weight will valid at the time of delivery.*

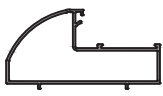
★ Yandaki profil birim ağırlıkları, bilgisayarda hesaplanmış teorik ağırlıklardır.

PROFİL KESİTİ	PROFİL KODU	PROFİL ADI	AĞIRLIK	ATALET MOMENTLERİ		SAYFA NO
				$J_x$ (cm <sup>4</sup> )	$J_y$ (cm <sup>4</sup> )	
	2924	Köşe Profili	1,949 kg/m	...	...	
	2923	Kasa Profili	1,208 kg/m	...	...	
	2939	Köşe Profili	1,691 kg/m	...	...	
	2922	Adaptör	0,810 kg/m	...	...	
	2921	Kapak Profili	0,196 kg/m	...	...	
	2944	Bağlantı Profili	0,670 kg/m	...	...	
	2925	Kapı Kasa Profili	1,297 kg/m	...	...	
	2920	Bağlantı Profili	0,503 kg/m	...	...	

2924
Köşe Profili
1,949 kg/m

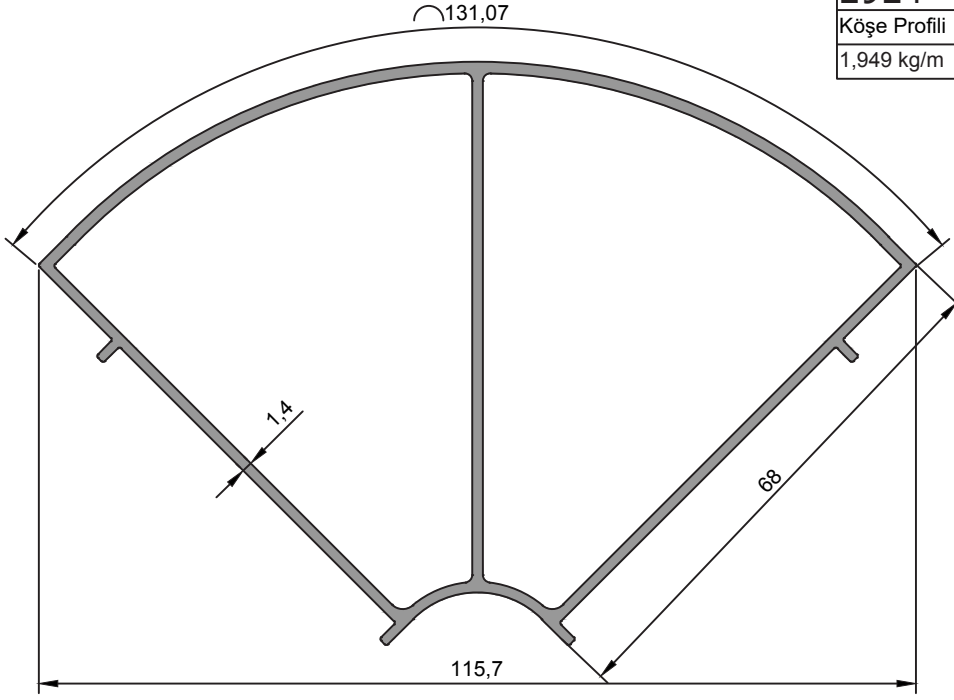

2923
Kasa Profili
1,208 kg/m

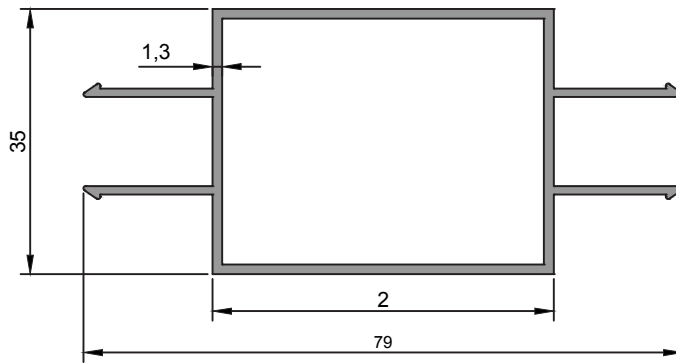

★ Yandaki profil birim ağırlıkları, bilgisayarda hesaplanmış teorik ağırlıklardır.

★ Yandaki profil birim ağırlıkları, bilgisayarda hesaplanmış teorik ağırlıklardır.

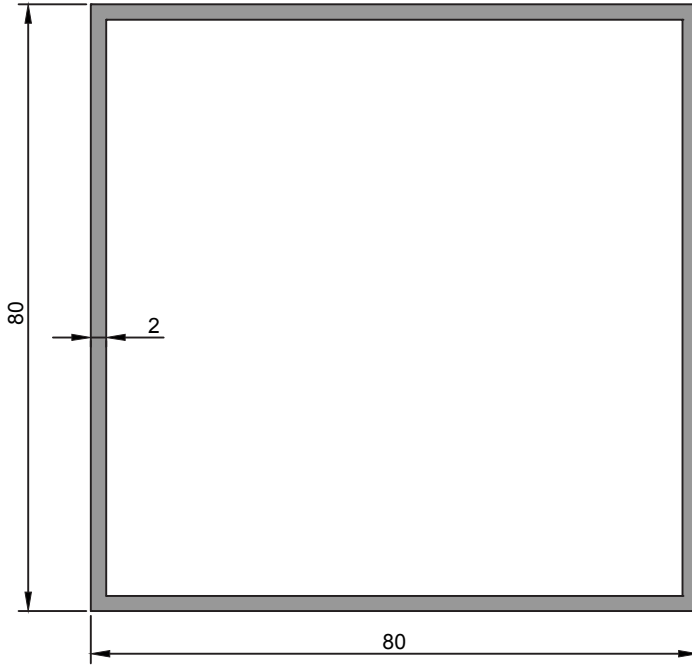

<b>2939</b>
Köşe Profili
1,691 kg/m

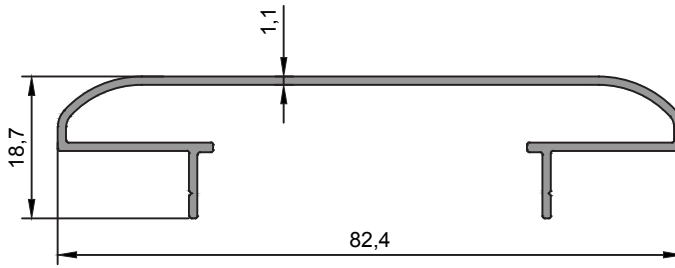

<b>2922</b>
Adaptör
0,810 kg/m

★ Yandaki profil birim ağırlıkları, bilgisayarla hesaplanmış teorik ağırlıklardır.

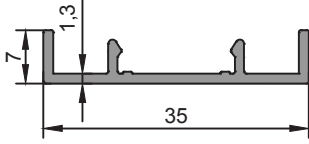

<b>2921</b>
Kapak Profili
0,196 kg/m

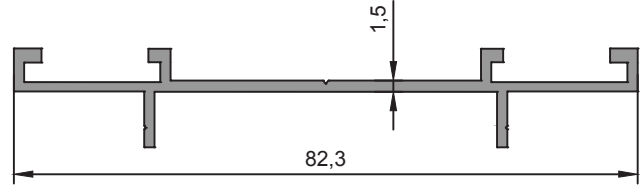

<b>2944</b>
Bağlantı Profili
0,670 kg/m

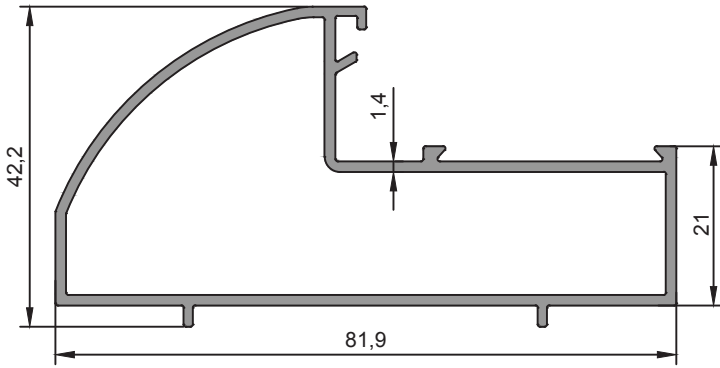

<b>2925</b>
Kapı Kasa Profili
1,297 kg/m

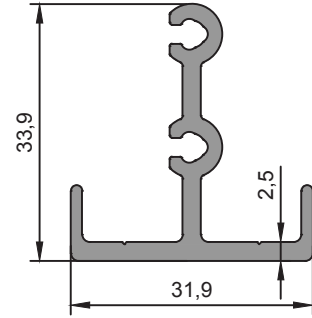

<b>2920</b>
Bağlantı Profili
0,503 kg/m

★ Yandaki profil birim ağırlıkları, bilgisayarda hesaplanmış teorik ağırlıklardır.

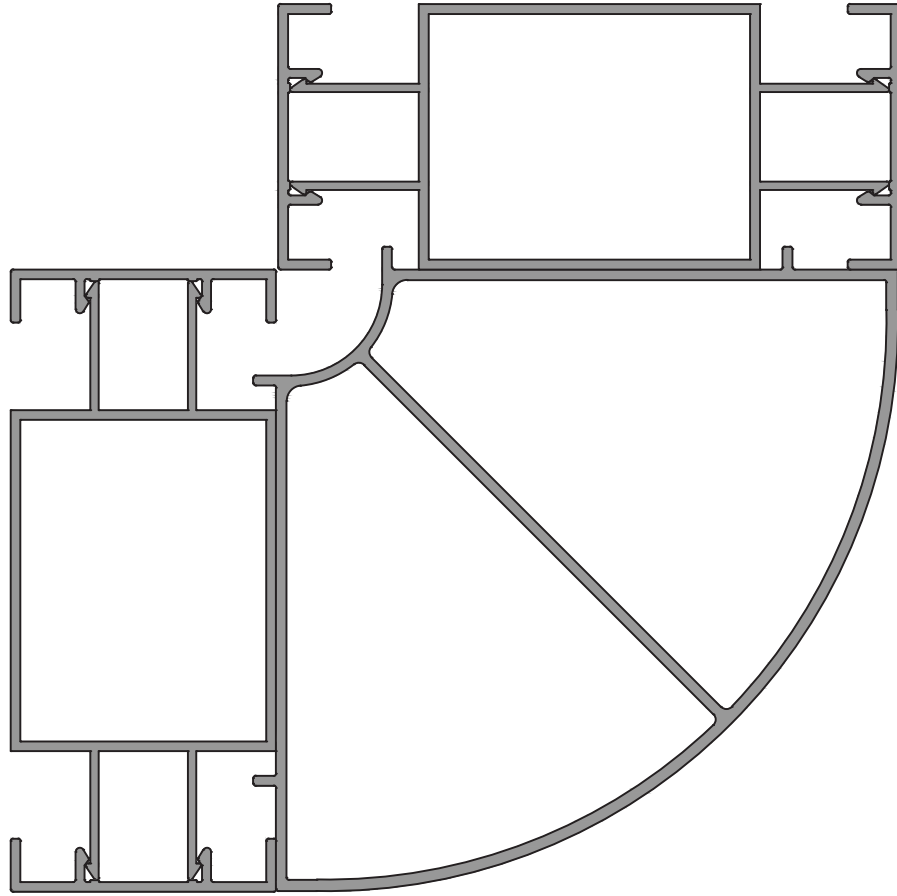

★ Yandaki profil birim ağırlıkları, bilgisayarda hesaplanmış teorik ağırlıklardır.

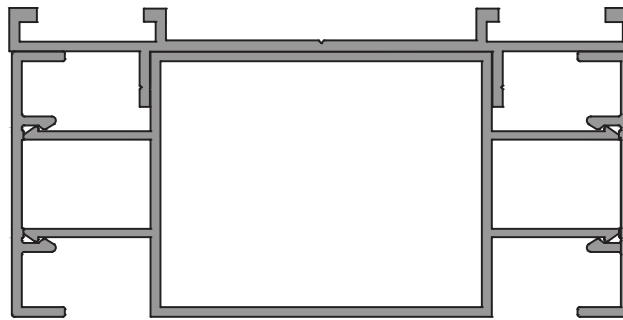
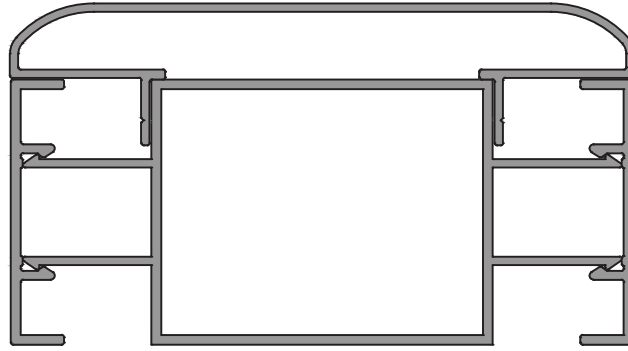

★ Yandaki profil birim ağırlıkları, bilgisayarla hesaplanmış teorik ağırlıklardır.

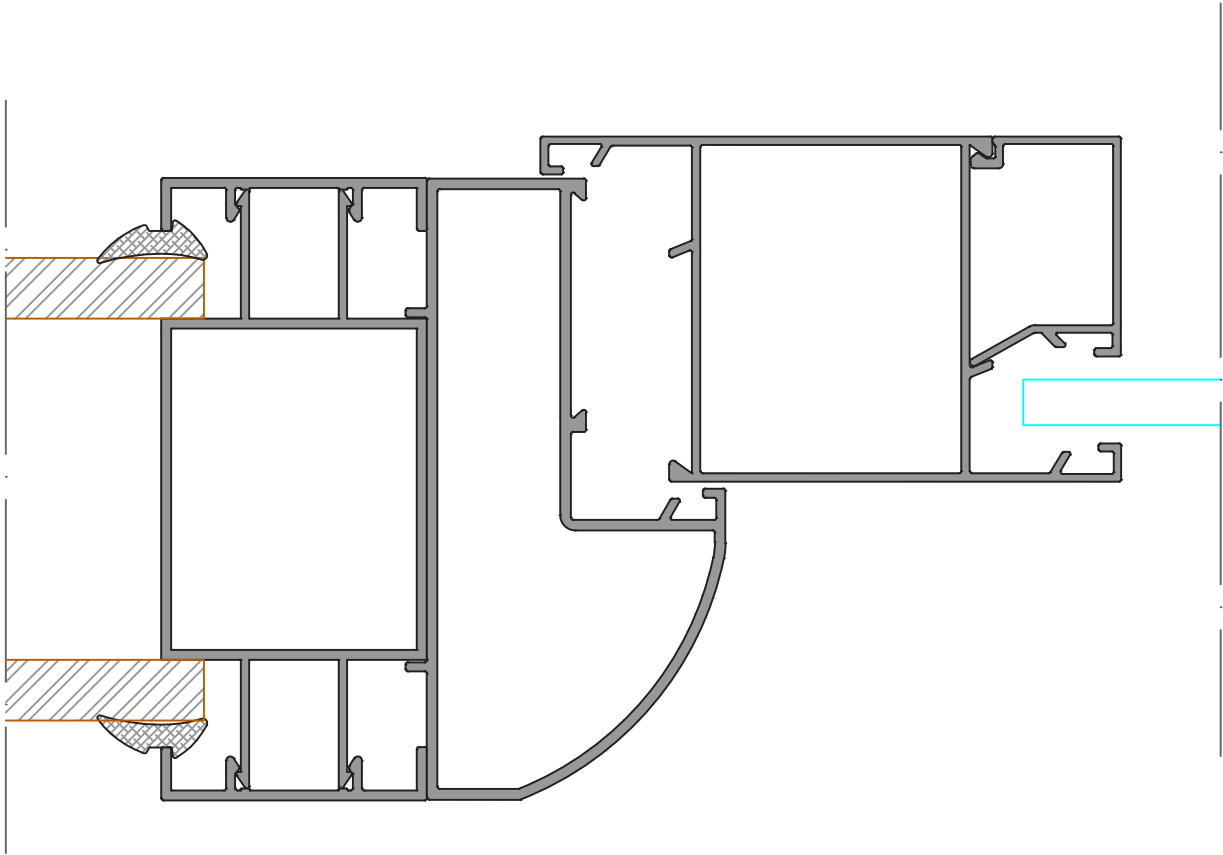





## PROFİL KATALOĐU











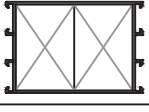

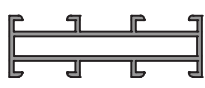
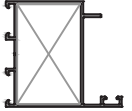
# HC60 SERİ

HC60 SERIE

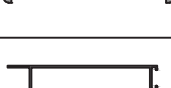

★ Profil Ađırlıkları Teorik Olup Teslim Anındaki Ađırlık Geerlidir

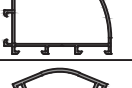
★ *Weight of profiles are theoretical, net weight will valid at the time of delivery.*

★ Yandaki profil birim ağırlıkları, bilgisayarda hesaplanmış teorik ağırlıklardır.

PROFİL KESİTİ	PROFİL KODU	PROFİL ADI	AĞIRLIK	ATALET MOMENTLERİ		SAYFA NO
				$J_x$ (cm <sup>4</sup> )	$J_y$ (cm <sup>4</sup> )	
	1117	Kasa ve Orta Kayıt	0,952 kg/m	17,56	11,37	
	2131	Kasa ve Orta Kayıt	1,410 kg/m	57,22	30,55	
	4149_1	Takviyeli Orta Kayıt	2,010 kg/m	146,67	30,73	
	4197	Dar Kasa ve Orta	0,761 kg/m	10,73	0,76	
	1118	Kanat	1,013 kg/m	21,51	13,49	
	4178	Geniş Kanat	1,492 kg/m	62,06	32,71	
	1132	Kasa Adaptörü	0,414 kg/m	6,72	0,61	
	2129	Çarpma Adaptörü	0,408 kg/m	5,82	0,14	
	4183	Çarpma Adaptörü	0,323 kg/m	4,39	0,12	
	2130	Çarpma Kapı Adaptörü	0,426 kg/m	7,29	0,20	
	4189	Etek Profili	1,812 kg/m	131,49	44,01	
	1130	90° Dönüş Profili	1,083 kg/m	25,33	15,42	
	4150	135° Dönüş Profili	1,173 kg/m	17,92	10,18	
	2367	Dik Bağlantı	1,274 kg/m			

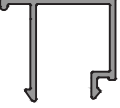
★ Yandaki profil birim ağırlıkları, bilgisayarda hesaplanmış teorik ağırlıklardır.

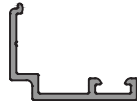
PROFİL KESİTİ	PROFİL KODU	PROFİL ADI	AĞIRLIK	ATALET MOMENTLERİ		SAYFA NO
				$J_x$ (cm <sup>4</sup> )	$J_y$ (cm <sup>4</sup> )	
	4180	Dik Bağlantı	0,800 kg/m			
	1089	Cam Çıtası	0,230 kg/m			
	1087	Cam Çıtası	0,211 kg/m			
	1838	Ek Profil	0,190 kg/m			







★ Yandaki profil birim ağırlıkları, bilgisayarda hesaplanmış teorik ağırlıklardır.

AKSESUAR KESİTİ	AKSESUAR KODU	AKSESUAR ADI	AĞIRLIK	PAKETLEME	SAYFA NO
	HL04	İç Cam Fitili - 3 mm	60 gr/m	15 kg/ 250 m	
	HL07	İç Cam Fitili - 4 mm	63 gr/m	15 kg/ 238 m	
	HL02	İç Cam Fitili - 4.5 mm	85 gr/m	15 kg/ 175 m	
	HL31	İç Cam Fitili - 2 mm	39 gr/m	15 kg/ 375 m	
	HA57-C60	KaucukPlastik		100 mt/ 1 Paket	
	HA31-02/09-1	Tek Büküm Oval Yale Kol (Paslanmaz)		1 Takım	
	HA31-11	Boru Kol		1 Takım	
	HA31-01	Yaylı Sosis Kol		1 Takım	
	HA31-09/13	Yaylı Dar Aynalı Sosis Kol		1 Takım	
	HA31-07/2Y	Yaylı Düz Rozetli Sosis Kol		1 Takım	
	HA31-24/20	Akbank 40'lık Kol Aparatı		1 Takım	
	HA31-24/2H	Akbank Havuzlu Kol Aparatı		1 Takım	
	HA34-01/4/5	62 mm Barel		1 Adet	
	HA33-10	Savio Uzun Sürgü		1 Adet	

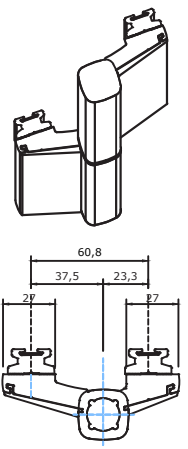
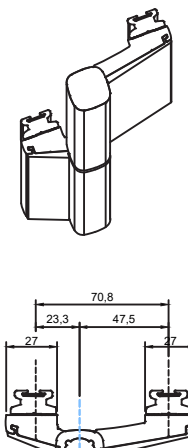
AKSESUAR KESİTİ	AKSESUAR KODU	AKSESUAR ADI	AĞIRLIK	PAKETLEME	SAYFA NO
	HA33-13	Savio Kısa Sürgü		200 Ad/paket	
	HA34-04/1-N	Dilli Kilit (153-25)		30 Ad/paket	
	HA34-02/1N	Makaralı Kilit (155-25)		30 Ad/paket	
	HA33-06/1/3	C60 Dilli Kilit Karşılığı		400 Ad/paket	
	HA33-06/02/3	C60 Makaralı Kilit Karşılığı		400 Ad/paket	
	HA33-06/1/2-4	Elektrikli Kilit Karşılığı		400 Ad/paket	
	HA33-06/03	C60 Kilit Altı		400 Ad/paket	
	TS 71	Kapı Hidroliği			
	HA33-04/2	Kapı Altı Fırçası		100 Ad/paket	
	HA33-04/3	Y Kapı Alt Fırçası		100 Ad/paket	
 <p><b>HA33-04/2</b> ALÜ. KAPI ALTI FIRÇASI 1 Pk. 100 Adet 133g DOOR BOTTOM ALM. BRUSH</p>	HA33-04/2	Y Kapı Alt Fırçası		100 Ad/paket	

★ Yandaki profil ağırlıkları, bilgisayarda hesaplanmış teorik ağırlıklardır.

★ Yandaki profil birim ağırlıkları, bilgisayararda hesaplanmış teorik ağırlıklardır.

AKSESUAR KESİTİ	AKSESUAR KODU	AKSESUAR ADI	AĞIRLIK	PAKETLEME	SAYFA NO
	SDKM-45-075	Düz Kapazlama Mentеше		10 Ad/paket	
	SDKM-57-076	Düz Kapazlama Mentеше		10 Ad/paket	
	HA32-28/5	C60 Orta Kayıt Bağlantı		500 Ad/paket	
	HA32-31/1	Boyunlu Eksenel Kol Tek Dilli		1 Ad/paket	
	HA32-33/1	Avrupa Karşılık Zamak Ak 315		500 Ad/paket	
	HA32-23	C60 Mentеше İkili		50 Ad/paket	
	HA32-22/11	Oval C60 Mentеше		50 Ad/paket	
	HA32-17/2	C60 Baba Mentеше		5x20 Ad/paket	

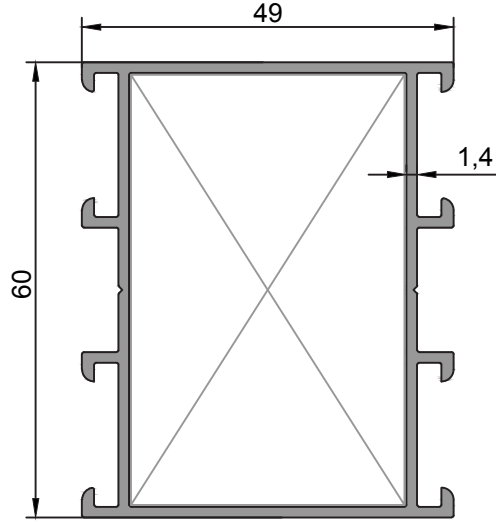

<b>1117</b>
Kasa ve Orta Kayıt
0,952 kg/m
$J_x=17,56 \text{ cm}^4$ $J_y=11,37 \text{ cm}^4$

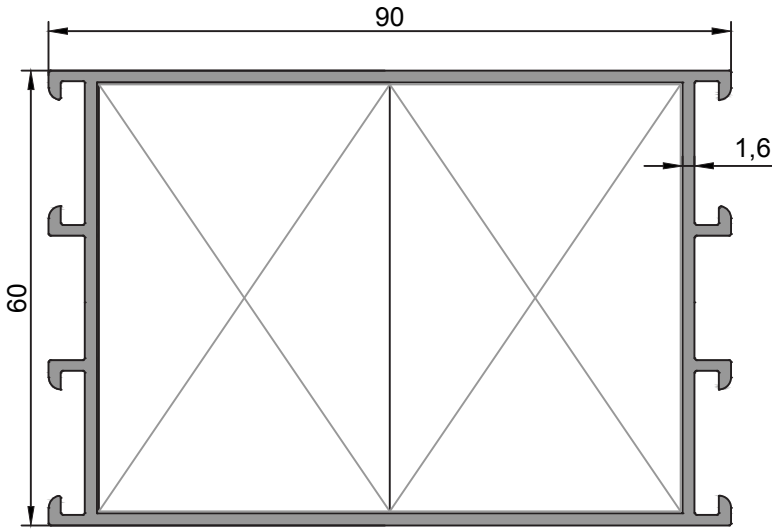

<b>2131</b>
Kasa ve Orta Kayıt
1,410 kg/m
$J_x=57,22 \text{ cm}^4$ $J_y=30,55 \text{ cm}^4$

★ Yandaki profil birim ağırlıkları, bilgisayarla hesaplanmış teorik ağırlıklardır.

★ Yandaki profil birim ağırlıkları, bilgisayarla hesaplanmış teorik ağırlıklardır.

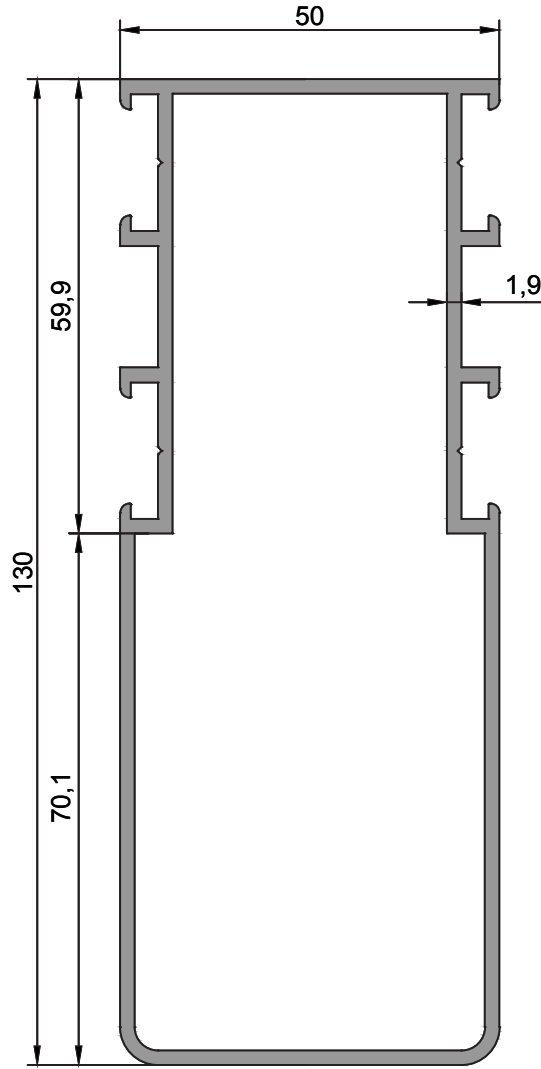

<b>4149_1</b>
Takviyeli Orta Kayıt
2,010 kg/m
$J_x=146,67 \text{ cm}^4$ $J_y=30,73 \text{ cm}^4$



★ Yandaki profil birim ağırlıkları, bilgisayarla hesaplanmış teorik ağırlıklardır.

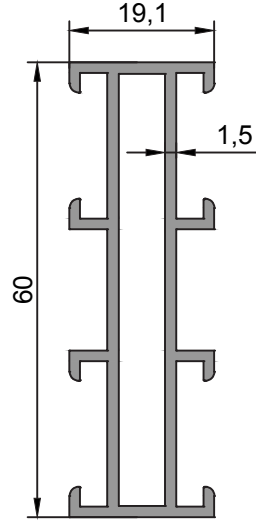

<b>4197</b>
Dar Kasa ve Orta
0,761 kg/m
Jx=10,73 cm <sup>4</sup> Jy=0,76 cm <sup>4</sup>

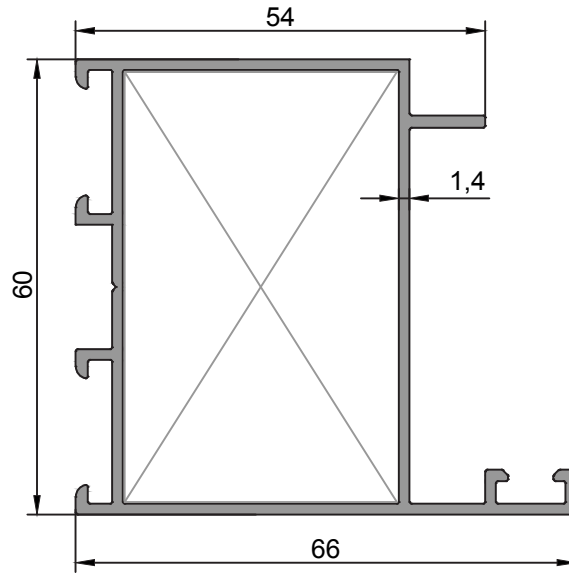

<b>1118</b>
Kanat
1,013 kg/m
Jx=21,51 cm <sup>4</sup> Jy=13,49 cm <sup>4</sup>

★ Yandaki profil birim ağırlıkları, bilgisayarla hesaplanmış teorik ağırlıklardır.

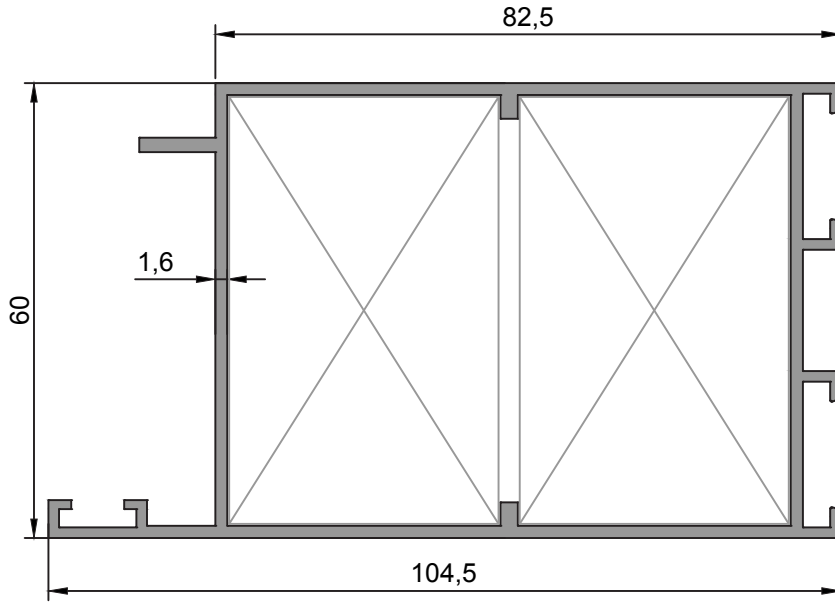

<b>4178</b>
Geniş Kanat
1,492 kg/m
Jx=62,06 cm <sup>4</sup> Jy=32,71 cm <sup>4</sup>

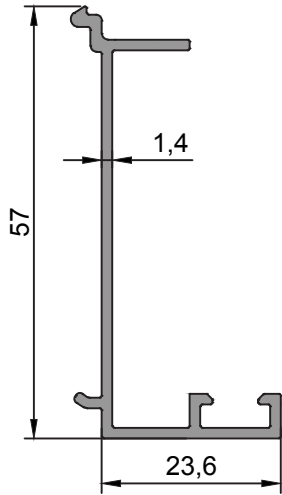

<b>1132</b>
Kasa Adaptörü
0,414 kg/m
Jx=6,72 cm <sup>4</sup> Jy=0,61 cm <sup>4</sup>

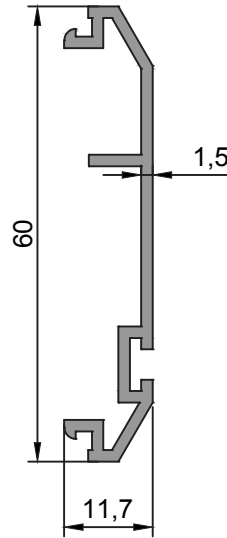

<b>2129</b>
Çarpma Adaptörü
0,408 kg/m
Jx=5,82 cm <sup>4</sup> Jy=0,14 cm <sup>4</sup>

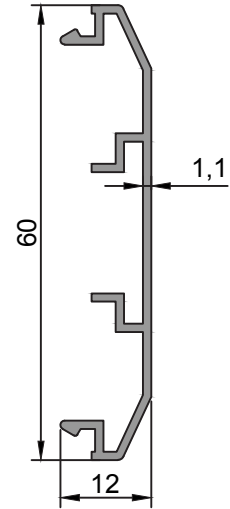

<b>4183</b>
Çarpma Adaptörü
0,323 kg/m
Jx=4,39 cm <sup>4</sup> Jy=0,12 cm <sup>4</sup>

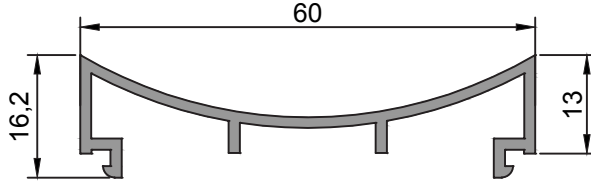

<b>2130</b>
Çarpma Kapı Adaptörü
0,426 kg/m
Jx=7,29 cm <sup>4</sup> Jy=0,20 cm <sup>4</sup>

★ Yandaki profil birim ağırlıkları, bilgisayarla hesaplanmış teorik ağırlıklardır.

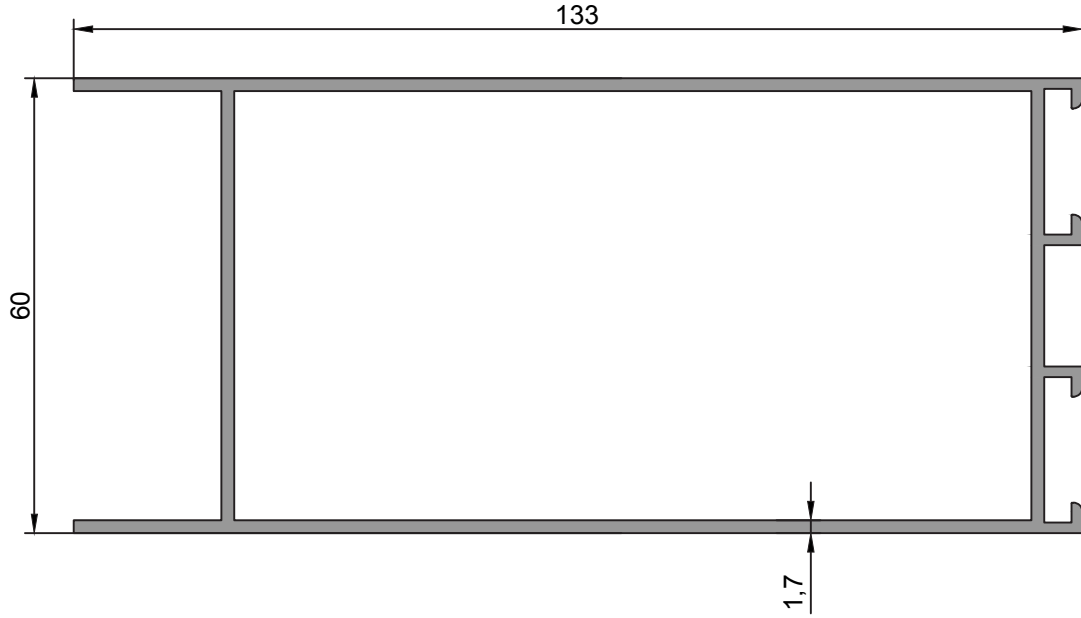

<b>4189</b>
Etek Profili
1,812 kg/m
Jx=131,49 cm <sup>4</sup> Jy=44,01 cm <sup>4</sup>

★ Yandaki profil birim ağırlıkları, bilgisayarla hesaplanmış teorik ağırlıklardır.

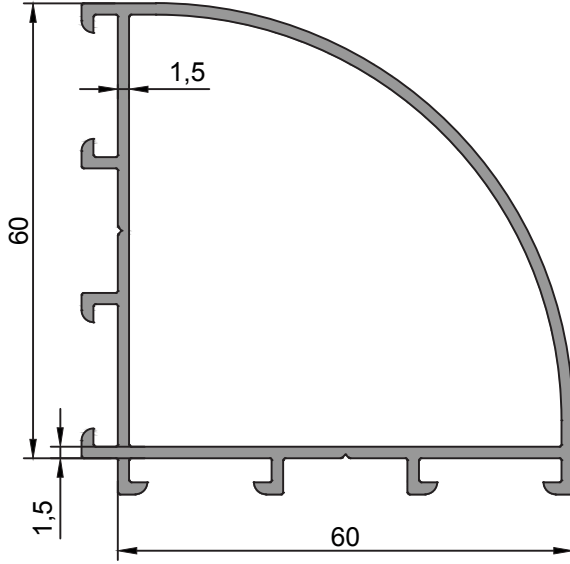

<b>1130</b>
90° Dönüş Profili
1,083 kg/m
$J_x=25,33 \text{ cm}^4$ $J_y=15,42 \text{ cm}^4$

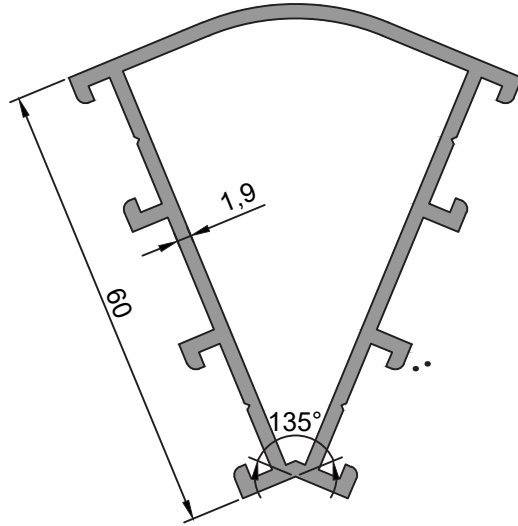

<b>4150</b>
135° Dönüş Profili
1,173 kg/m
$J_x=17,92 \text{ cm}^4$ $J_y=10,18 \text{ cm}^4$

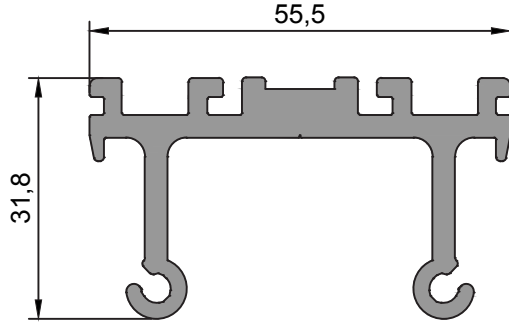

<b>2367</b>
Dik Bağlantı
1,274 kg/m

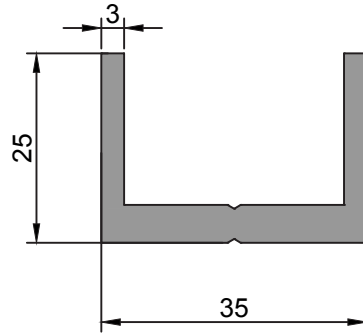

<b>4180</b>
Dik Bağlantı
0,800 kg/m

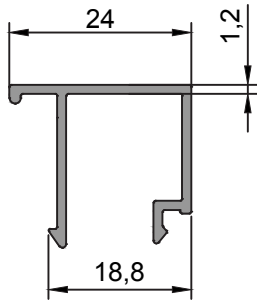

<b>1089</b>
Cam Çıtası
0,230 kg/m

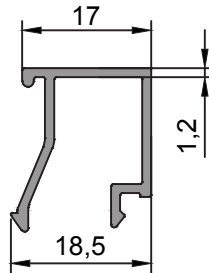

<b>1087</b>
Cam Çıtası
0,211 kg/m

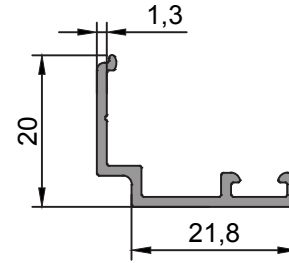

<b>1838</b>
Ek Profil
0,190 kg/m

★ Yandaki profil birim ağırlıkları, bilgisayarda hesaplanmış teorik ağırlıklardır.

★ Yandaki profil birim ağırlıkları, bilgisayarla hesaplanmış teorik ağırlıklardır.

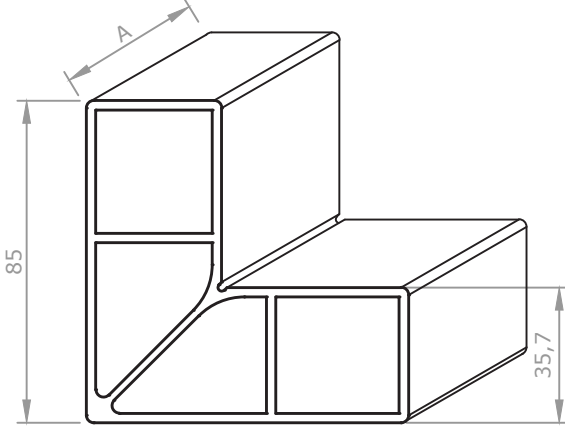

<b>K4507</b>
Köşe Takozu
2,930 kg/m

Aksesuar Kodu	Profil Kodu	Kesim Ölçüsü A(mm)
K4507 563	4178	56.3

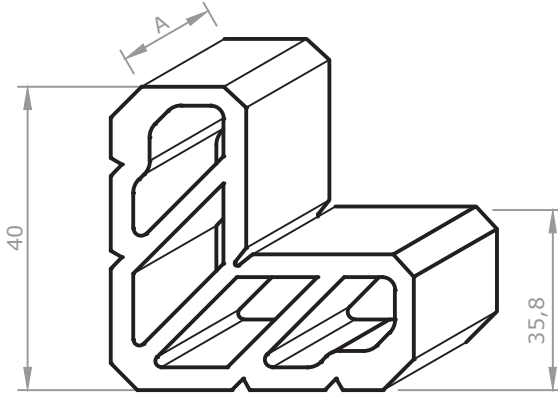

<b>K3272</b>
Köşe Takozu
6,230 kg/m

Aksesuar Kodu	Profil Kodu	Kesim Ölçüsü A(mm)
K3272 567	1117	56.7
K3272 563	2131	56.3
K3272 567	1118	56.7

## PENCERE UYGULAMA TİPLERİ

★ Yandaki profil birim ağırlıkları, bilgisayarla hesaplanmış teorik ağırlıklardır.

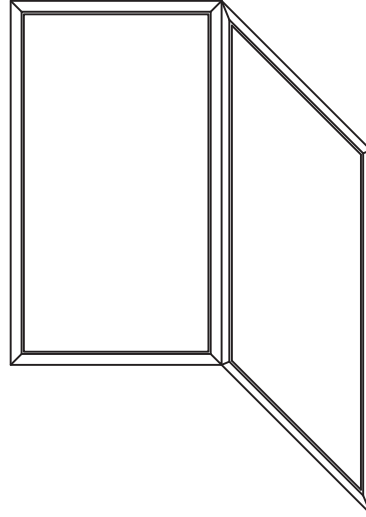
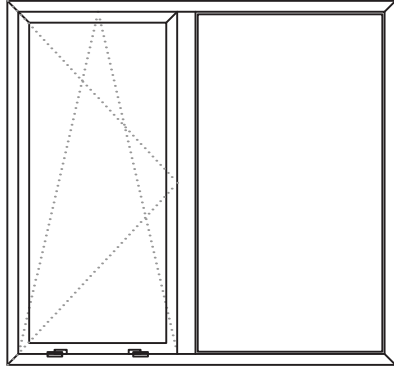
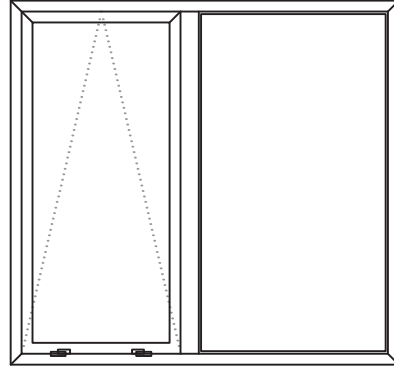
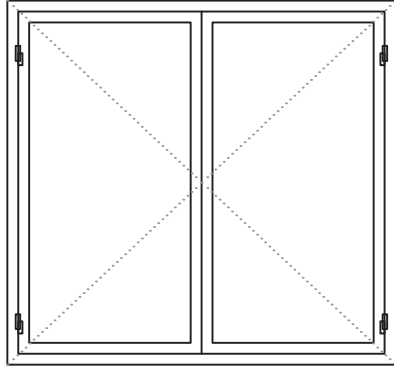

### DETAY-1 ÖLÇEK:1/1

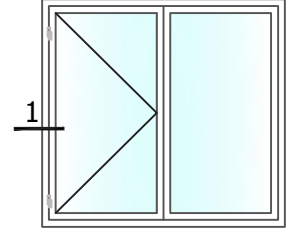

★ Yandaki profil birim ağırlıkları, bilgisayarla hesaplanmış teorik ağırlıklardır.

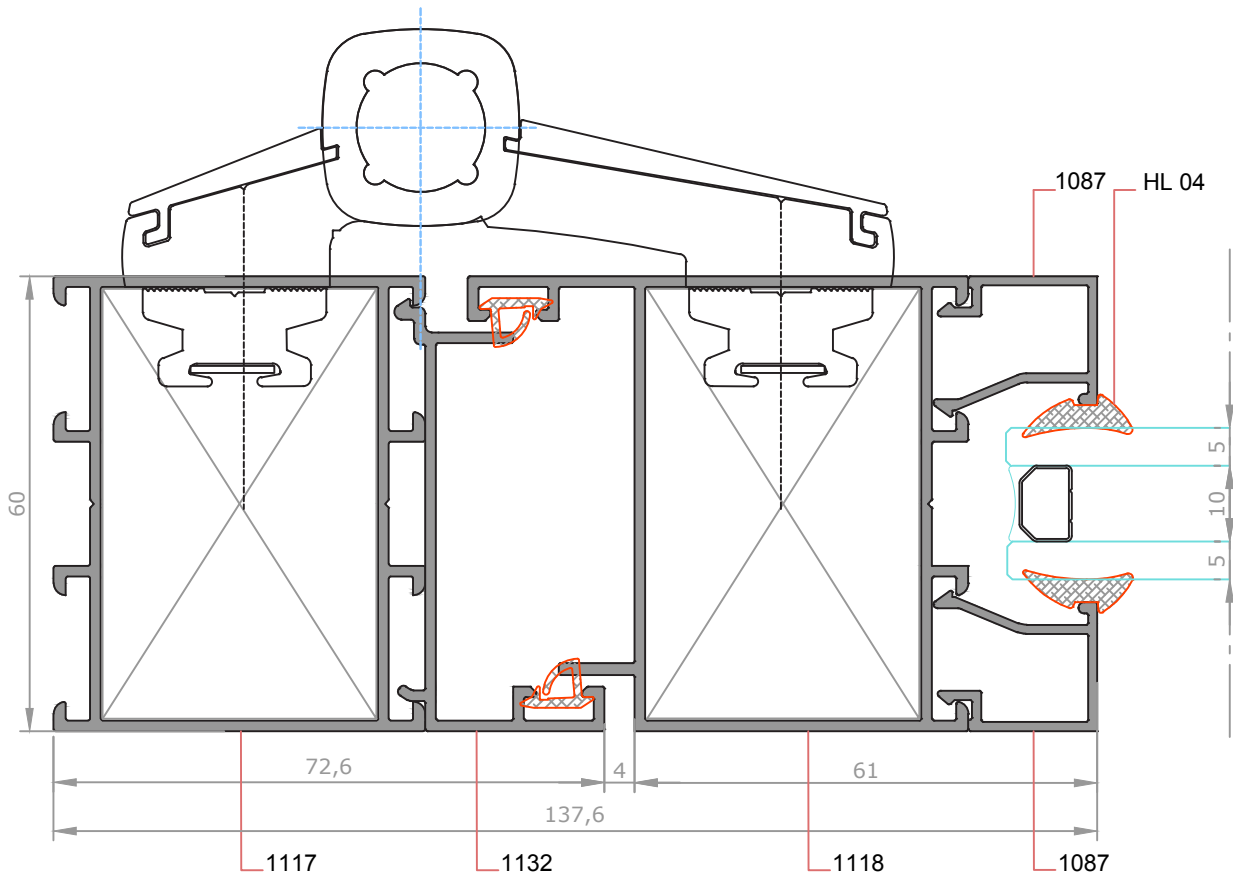



### DETAY-2 ÖLÇEK:1/1

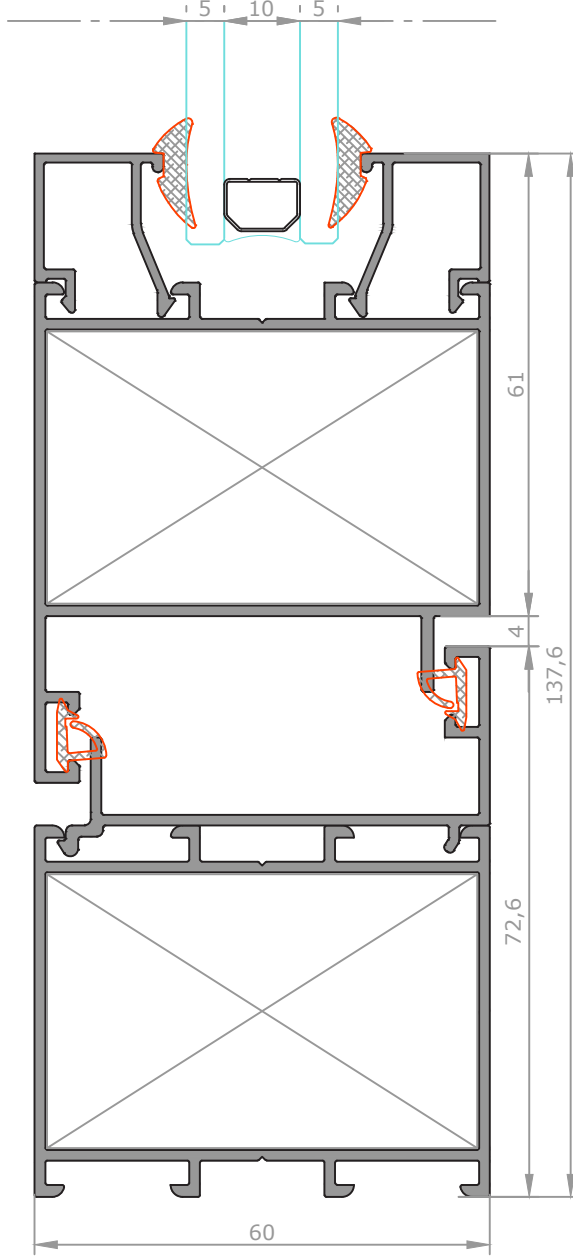
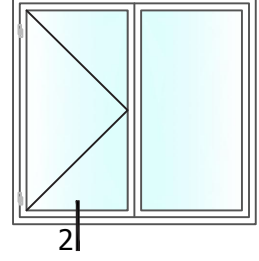

★ Yandaki profil birim ağırlıkları, bilgisayarla hesaplanmış teorik ağırlıklardır.

### DETAY-3 ÖLÇEK:1/1

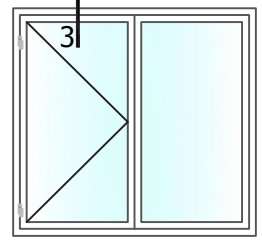

★ Yandaki profil birim ağırlıkları, bilgisayarla hesaplanmış teorik ağırlıklardır.

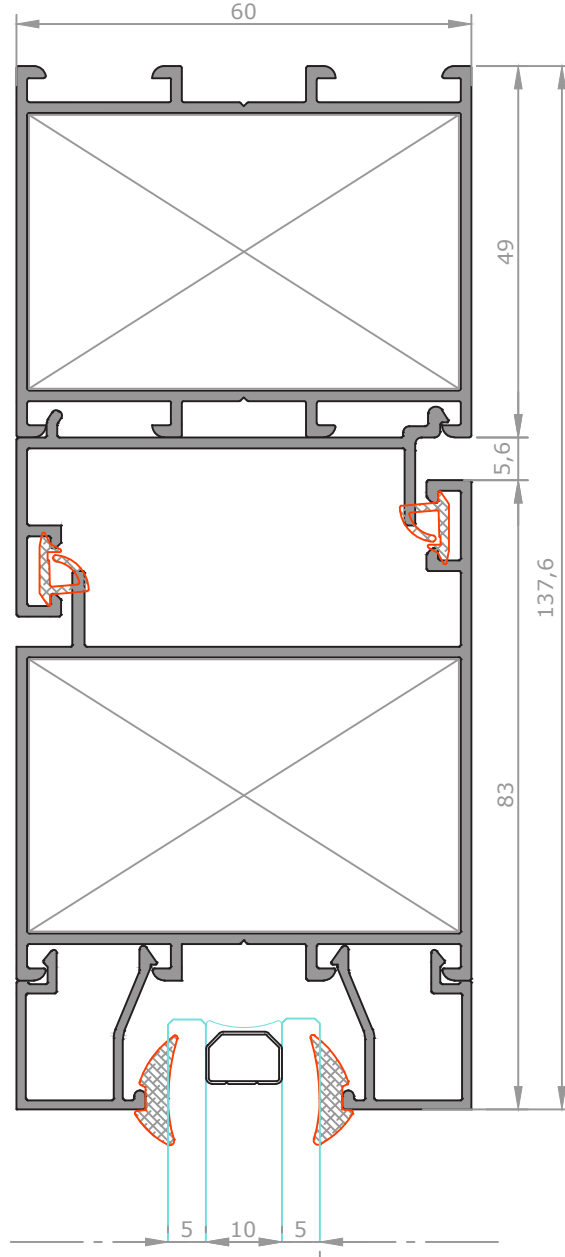

### DETAY-4 ÖLÇEK:1/1

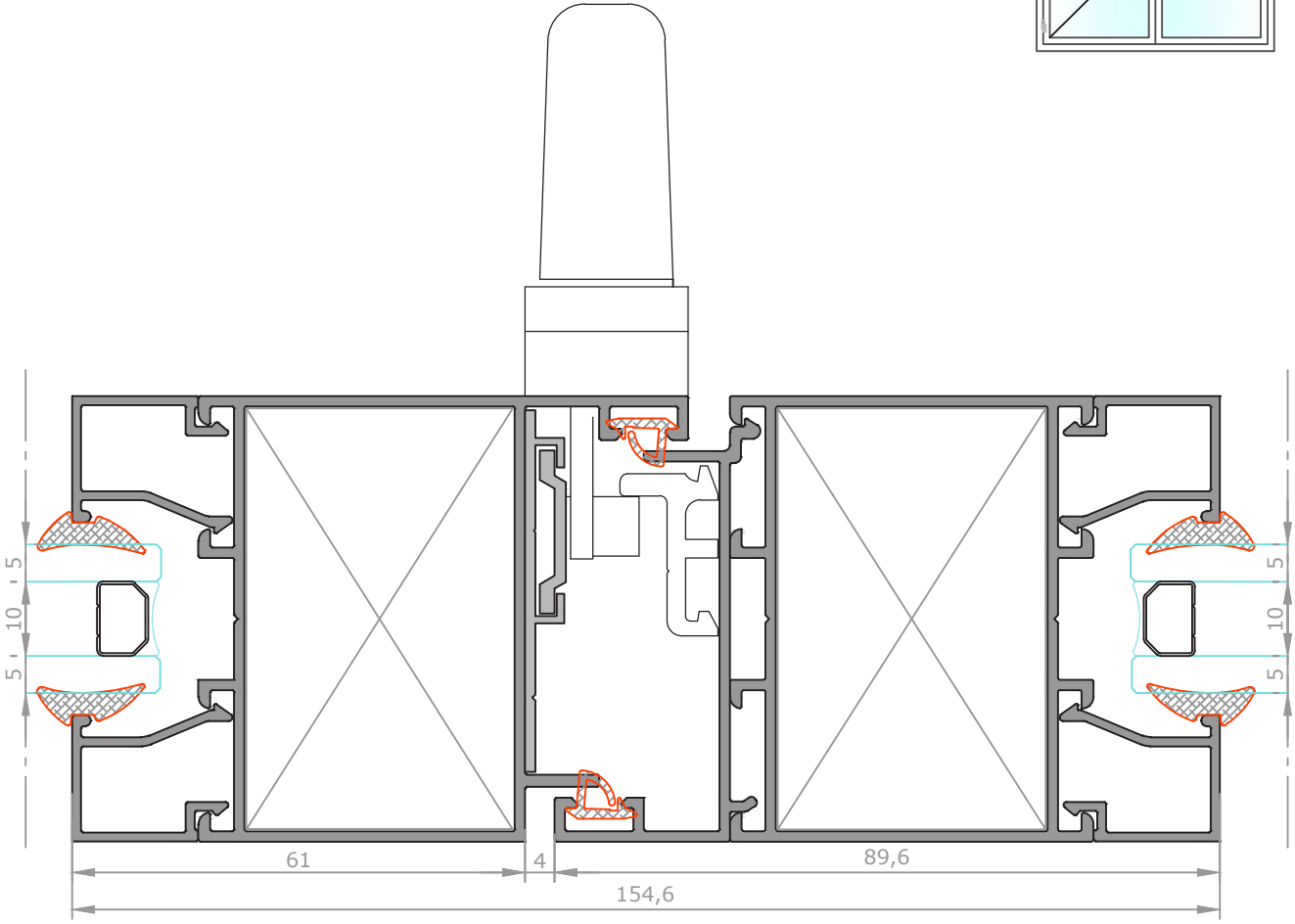
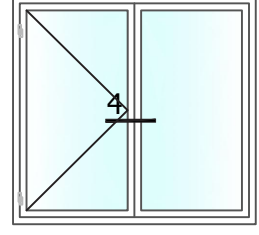

★ Yandaki profil birim ağırlıkları, bilgisayarda hesaplanmış teorik ağırlıklardır.

**DETAY-5**  
ÖLÇEK:1/1

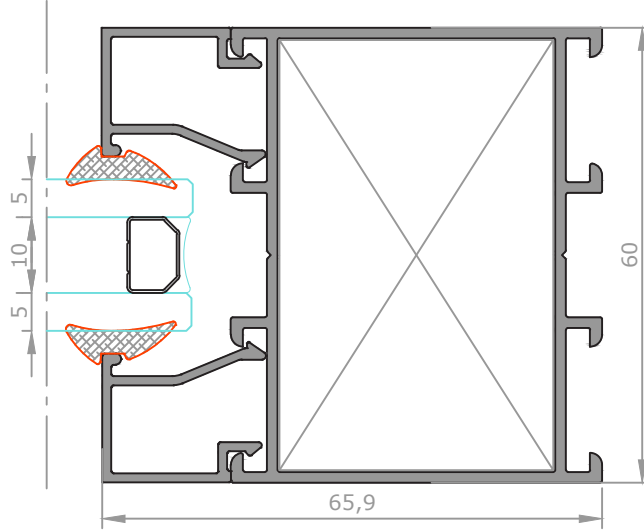
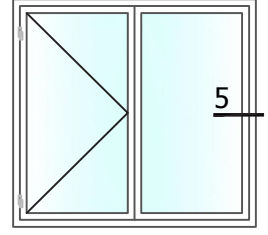

★ Yandaki profil birim ağırlıkları, bilgisayarla hesaplanmış teorik ağırlıklardır.

**DETAY- 1a**  
ÖLÇEK:1/1

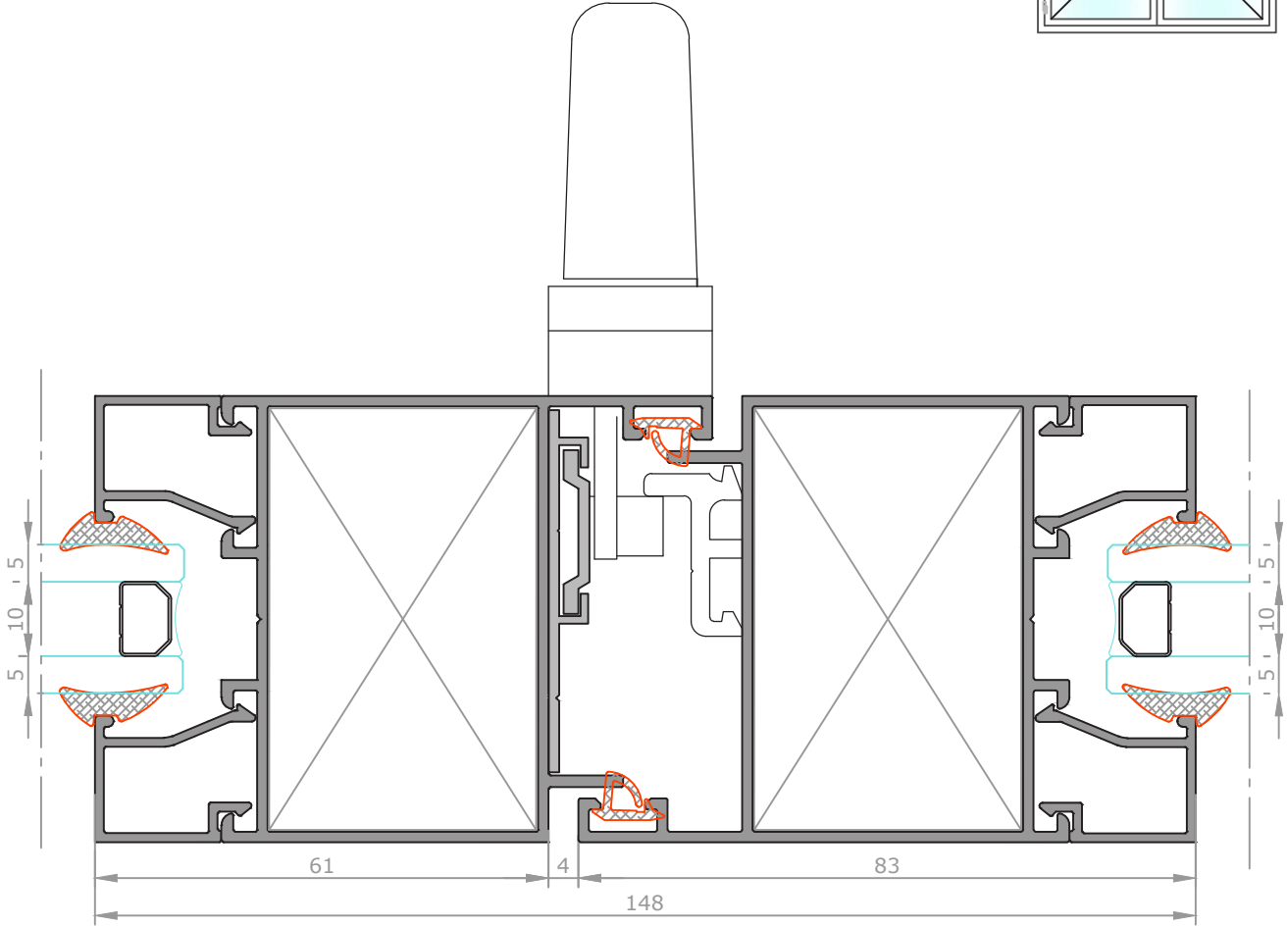
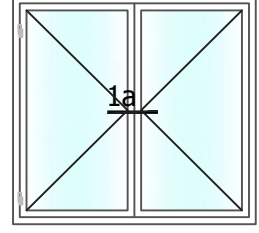

★ Yandaki profil birim ağırlıkları, bilgisayarda hesaplanmış teorik ağırlıklardır.

## KAPI UYGULAMA TİPLERİ

★ Yandaki profil birim ağırlıkları, bilgisayarla hesaplanmış teorik ağırlıklardır.

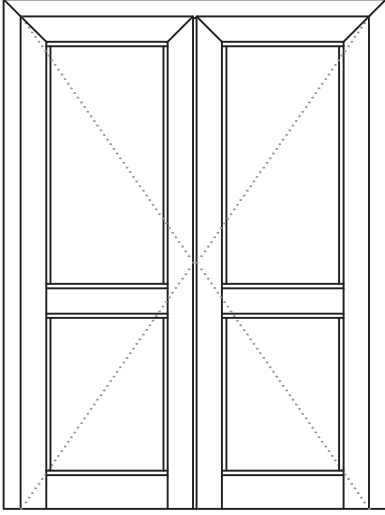

*İçe Açılır Kapı*

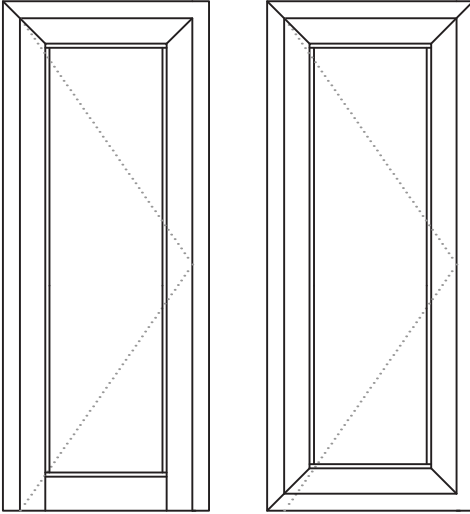

*İçe Açılır Kapı*

### DETAY- 1

ÖLÇEK:1/1

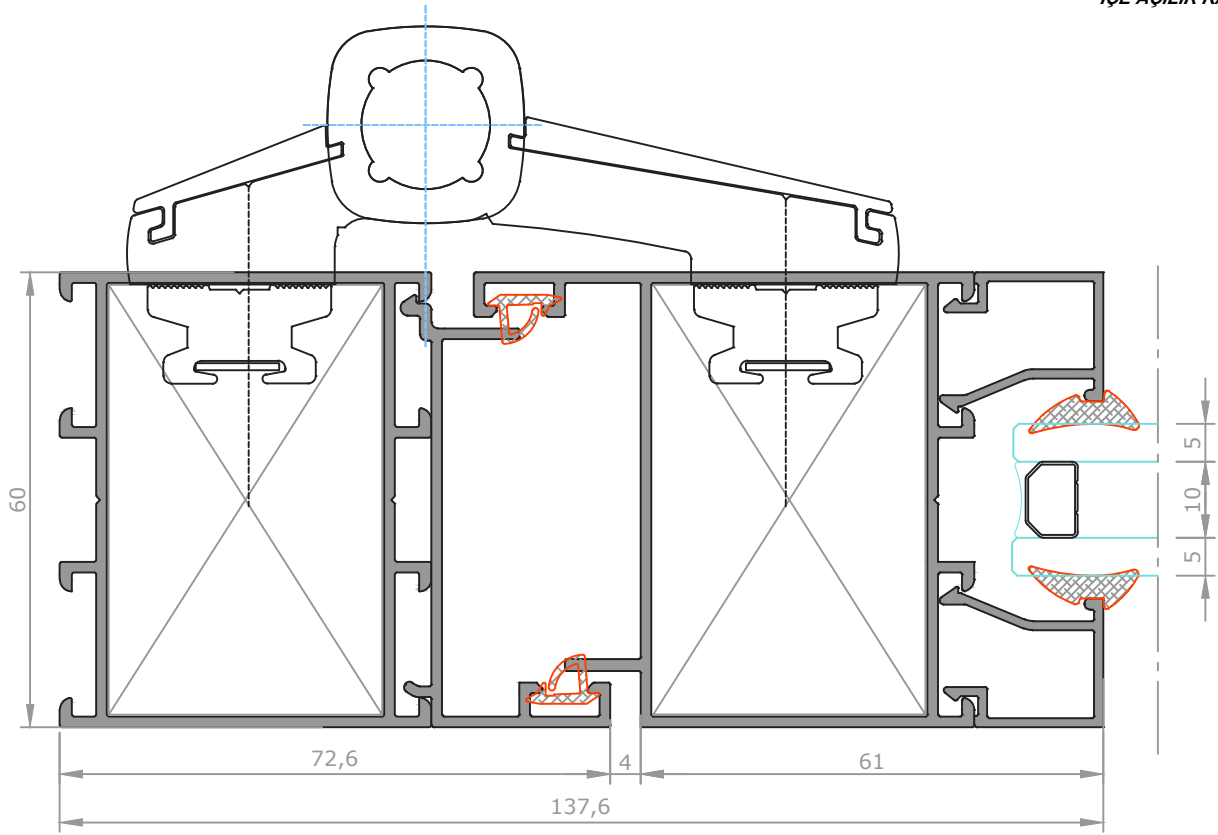
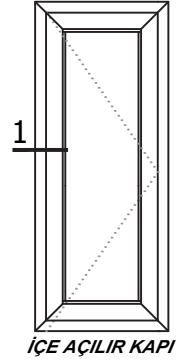

★ Yandaki profil birim ağırlıkları, bilgisayarla hesaplanmış teorik ağırlıklardır.

### DETAY-2a ÖLÇEK:1/1

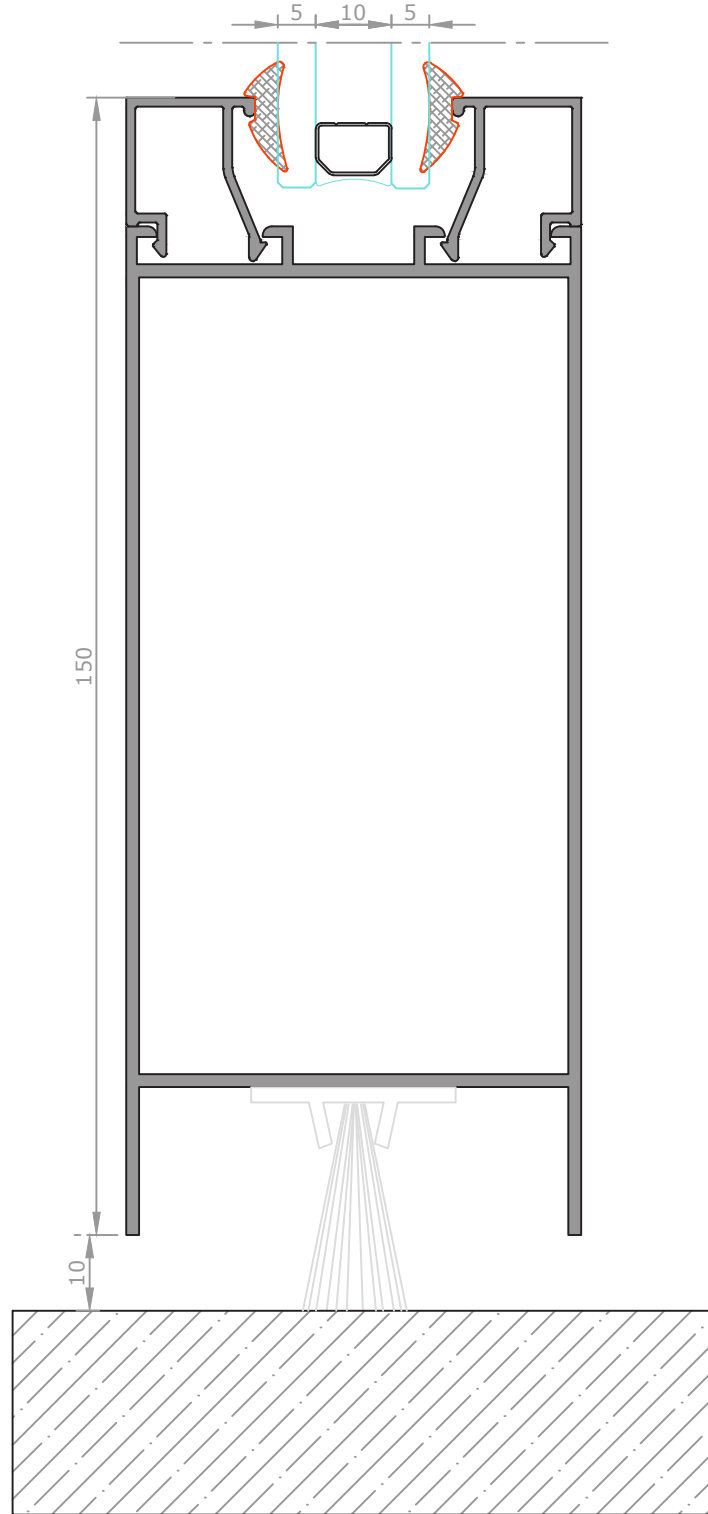
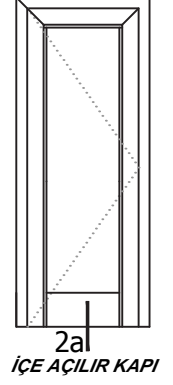

★ Yandaki profil birim ağırlıkları, bilgisayarda hesaplanmış teorik ağırlıklardır.



**DETAY- 2b**  
ÖLÇEK:1/1

★ Yandaki profil birim ağırlıkları, bilgisayarla hesaplanmış teorik ağırlıklardır.

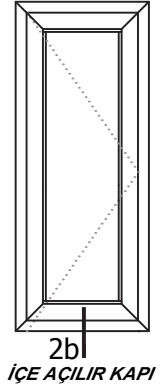
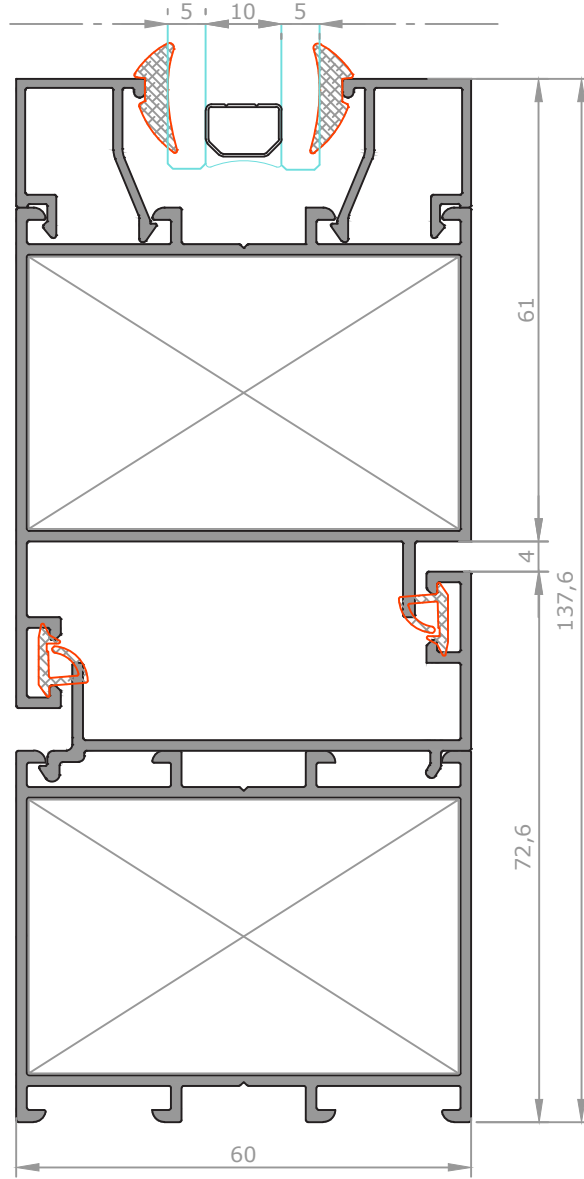

### DETAY- 3 ÖLÇEK:1/1

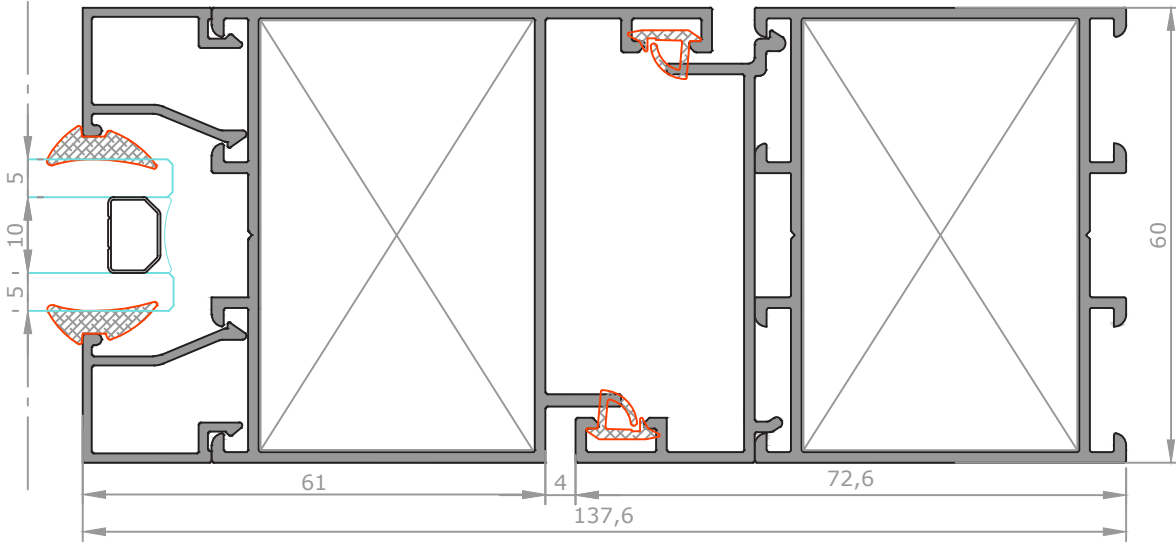
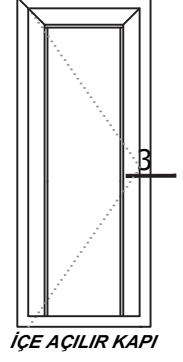

★ Yandaki profil birim ağırlıkları, bilgisayarda hesaplanmış teorik ağırlıklardır.

**DETAY- 4**

ÖLÇEK:1/1

★ Yandaki profil birim ağırlıkları, bilgisayarla hesaplanmış teorik ağırlıklardır.

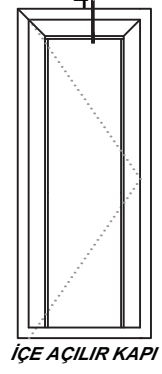
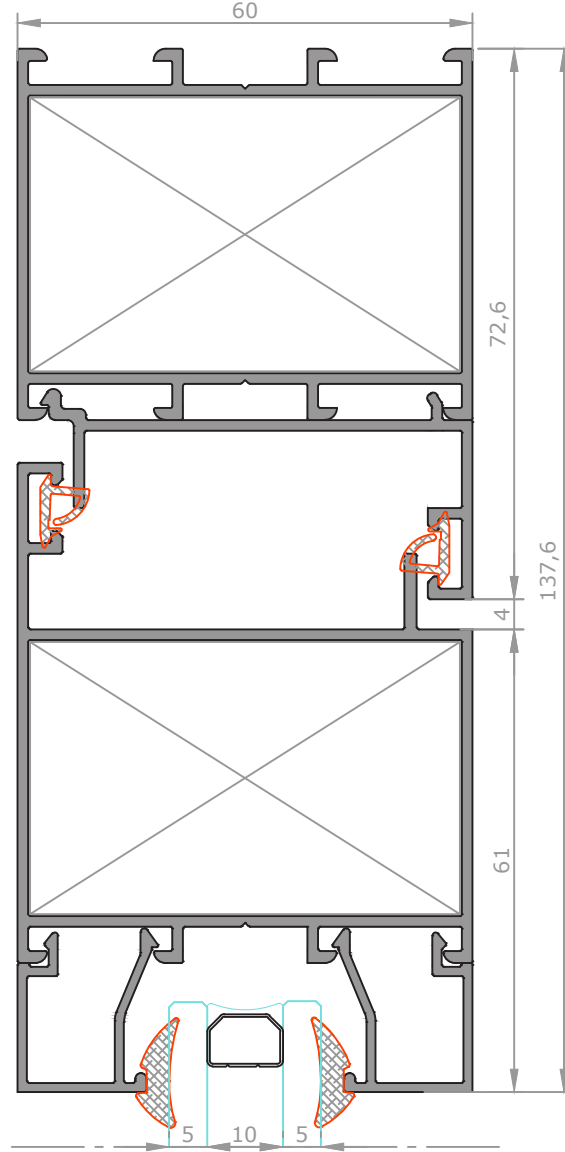

### DETAY- 5 ÖLÇEK:1/1

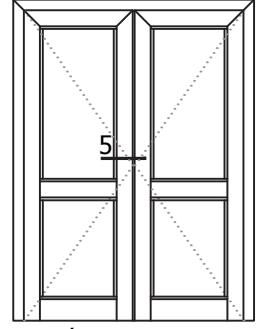

İÇE AÇILIR KAPI

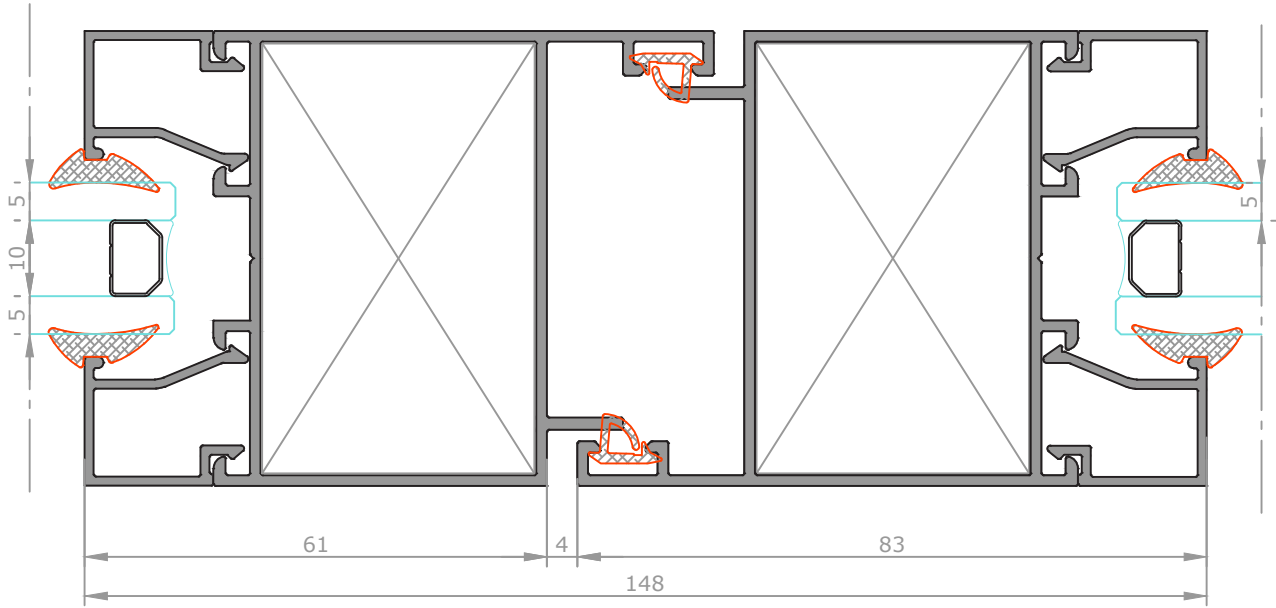

★ Yandaki profil birim ağırlıkları, bilgisayarda hesaplanmış teorik ağırlıklardır.



## PROFİL KATALOĐU









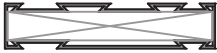
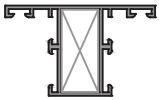
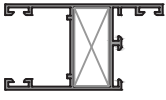

# DAR TUBA SERİSİ

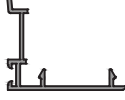
SLIDING WINDOWS SERIE

★ Profil Ağırlıkları Teorik Olup Teslim Anındaki Ağırlık Geçerlidir

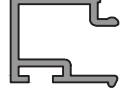
★ *Weight of profiles are theoretical, net weight will valid at the time of delivery.*

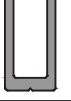
★ Yandaki profil birim ağırlıkları, bilgisayarda hesaplanmış teorik ağırlıklardır.

PROFİL KESİTİ	PROFİL KODU	PROFİL ADI	AĞIRLIK	ATALET MOMENTLERİ		SAYFA NO
				$J_x$ (cm <sup>4</sup> )	$J_y$ (cm <sup>4</sup> )	
	2100	Kasa Profili	0,687 kg/m	14,56	1,60	
	2101	Sineklikli Kasa Profili	0,919 kg/m	32,74	2,16	
	2103	Orta Kayıt Profili	0,553 kg/m	3,00	2,60	
	2102	Kanat Profili	0,636 kg/m	5,65	3,21	
	2113	Sabit Kasa Adaptör Profili	0,318 kg/m	1,50	0,35	
	2111	Kenet Adaptör Profili	0,296 kg/m	1,93	0,54	
	2112	Orta Kenet Profili	0,183 kg/m	...	...	
	2106	Alt Ray	0,160 kg/m	...	...	
	2107	Yan ve Üst Ray	0,127 kg/m	...	...	
	2110	Tek Cam Çıtası	0,191 kg/m	...	...	
	2109	Isı Cam Çıtası	0,147 kg/m	...	...	
	2115	K.Tuba Dik Bağlantı	0,335 kg/m	...	...	
	2114	KöşeTakoza	0,556 kg/m	...	...	

★ Yandaki profil birim ağırlıkları, bilgisayarla hesaplanmış teorik ağırlıklardır.

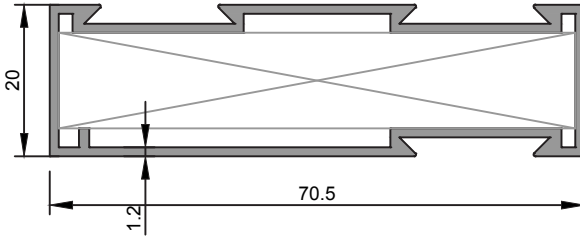

**2100**

Kasa Profili

0,687 kg/m

$J_x=14,56 \text{ cm}^4$   $J_y=1,60 \text{ cm}^4$

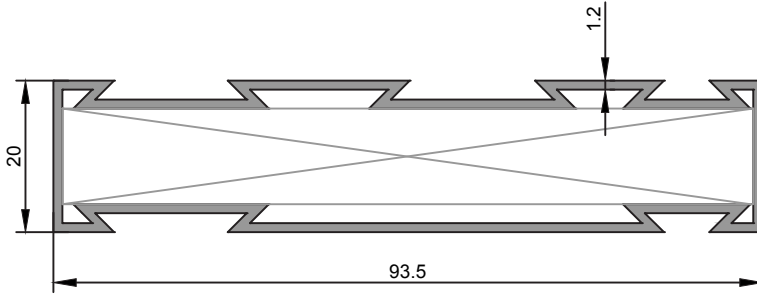

**2101**

Sineklikli Kasa Profili

0,919 kg/m

$J_x=32,74 \text{ cm}^4$   $J_y=2,16 \text{ cm}^4$

★ Yandaki profil birim ağırlıkları, bilgisayarla hesaplanmış teorik ağırlıklardır.

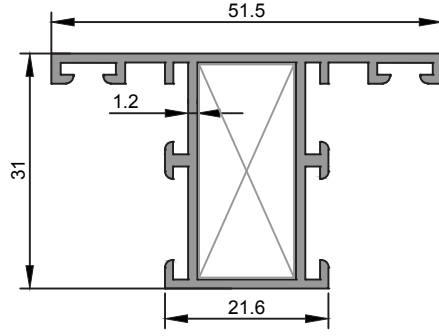

<b>2103</b>
Orta Kayıt Profili
0,553 kg/m
$J_x=3,00 \text{ cm}^4$ $J_y=2,60 \text{ cm}^4$

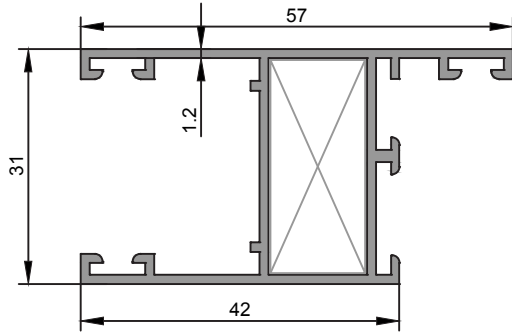

<b>2102</b>
Kanat Profili
0,636 kg/m
$J_x=5,65 \text{ cm}^4$ $J_y=3,21 \text{ cm}^4$



★ Yandaki profil birim ağırlıkları, bilgisayarla hesaplanmış teorik ağırlıklardır.

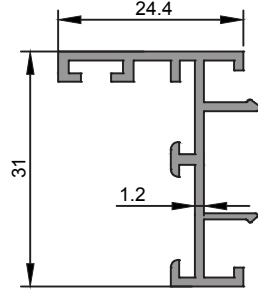

<b>2113</b>
Sabit Kasa Adaptör Profili
0,318 kg/m
$J_x=1,50 \text{ cm}^4$ $J_y=0,35 \text{ cm}^4$

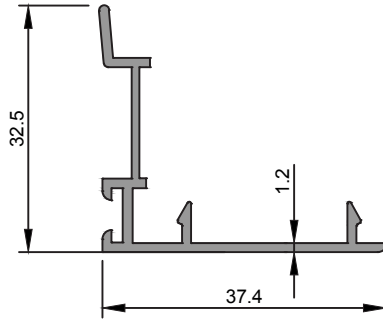

<b>2111</b>
Kenet Adaptör Profili
0,296 kg/m
$J_x=1,93 \text{ cm}^4$ $J_y=0,54 \text{ cm}^4$

★ Yandaki profil birim ağırlıkları, bilgisayarla hesaplanmış teorik ağırlıklardır.

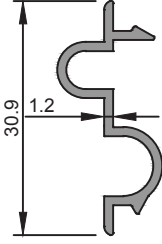

<b>2112</b>
Orta Kenet Profili
0,183 kg/m

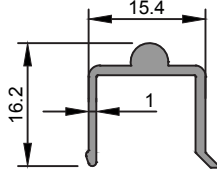

<b>2106</b>
Alt Ray
0,160 kg/m

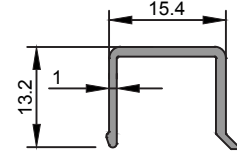

<b>2107</b>
Yan ve Üst Ray
0,127 kg/m

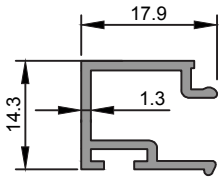

<b>2110</b>
Tek Cam Çıtası
0,191 kg/m

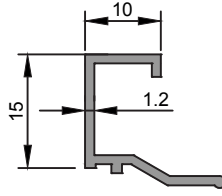

<b>2109</b>
İsı Cam Çıtası
0,147 kg/m

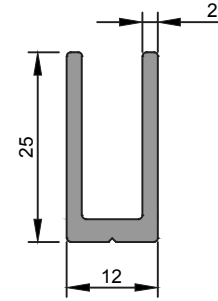

<b>2115</b>
K.Tuba Dik Bağlantı
0,335 kg/m

★ Yandaki profil birim ağırlıkları, bilgisayarla hesaplanmış teorik ağırlıklardır.

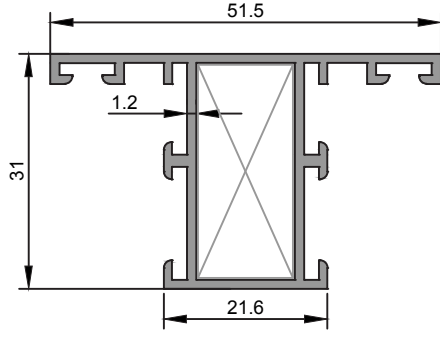

**2103**

Orta Kayıt Profili

0,553 kg/m

$J_x=3,00 \text{ cm}^4$   $J_y=2,60 \text{ cm}^4$

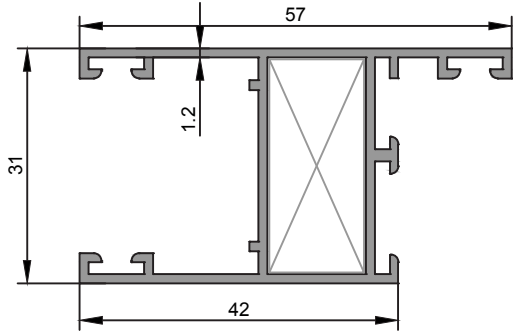

**2102**

Kanat Profili

0,636 kg/m

$J_x=5,65 \text{ cm}^4$   $J_y=3,21 \text{ cm}^4$

★ Yandaki profil birim ağırlıkları, bilgisayarla hesaplanmış teorik ağırlıklardır.

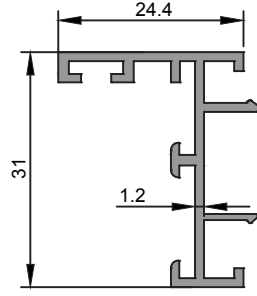

<b>2113</b>
Sabit Kasa Adaptör Profili
0,318 kg/m
Jx=1,50 cm <sup>4</sup> Jy=0,35 cm <sup>4</sup>

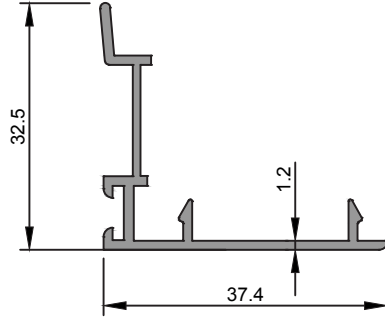

<b>2111</b>
Kenet Adaptör Profili
0,296 kg/m
Jx=1,93 cm <sup>4</sup> Jy=0,54 cm <sup>4</sup>

★ Yandaki profil birim ağırlıkları, bilgisayararda hesaplanmış teorik ağırlıklardır.

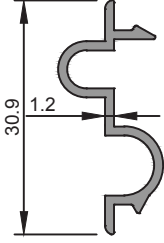

<b>2112</b>
Orta Kenet Profili
0,183 kg/m

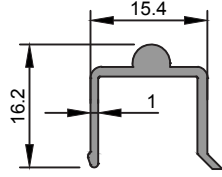

<b>2106</b>
Alt Ray
0,160 kg/m

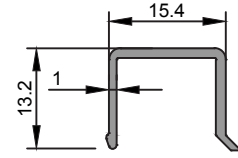

<b>2107</b>
Yan ve Üst Ray
0,127 kg/m

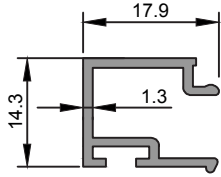

<b>2110</b>
Tek Cam Çıtası
0,191 kg/m

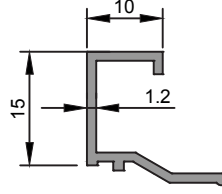

<b>2109</b>
İsı Cam Çıtası
0,147 kg/m

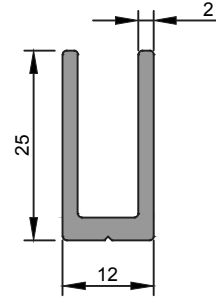

<b>2115</b>
K.Tuba Dik Bağlantı
0,335 kg/m

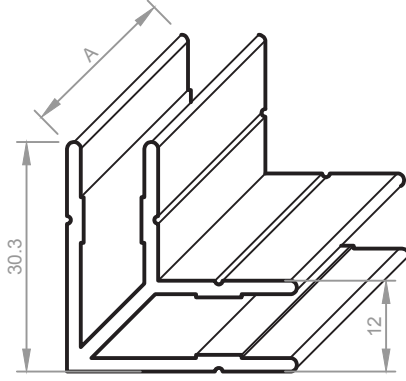
**KÖŞE TAKOZU KESİM ÖLÇÜLERİ**

<b>2114</b>
Köşe Takozu
0,556 kg/m

Aksesuar Kodu	Profil Kodu	Kesim Ölçüsü A(mm)
K2114 676	2100	67.6
K2114 906	2101	90.6
K2114 281	2102	28.1
K2114 281	2113	28.1

★ Yandaki profil birim ağırlıkları, bilgisayarda hesaplanmış teorik ağırlıklardır.

★ Yandaki profil birim ağırlıkları, bilgisayararda hesaplanmış teorik ağırlıklardır.

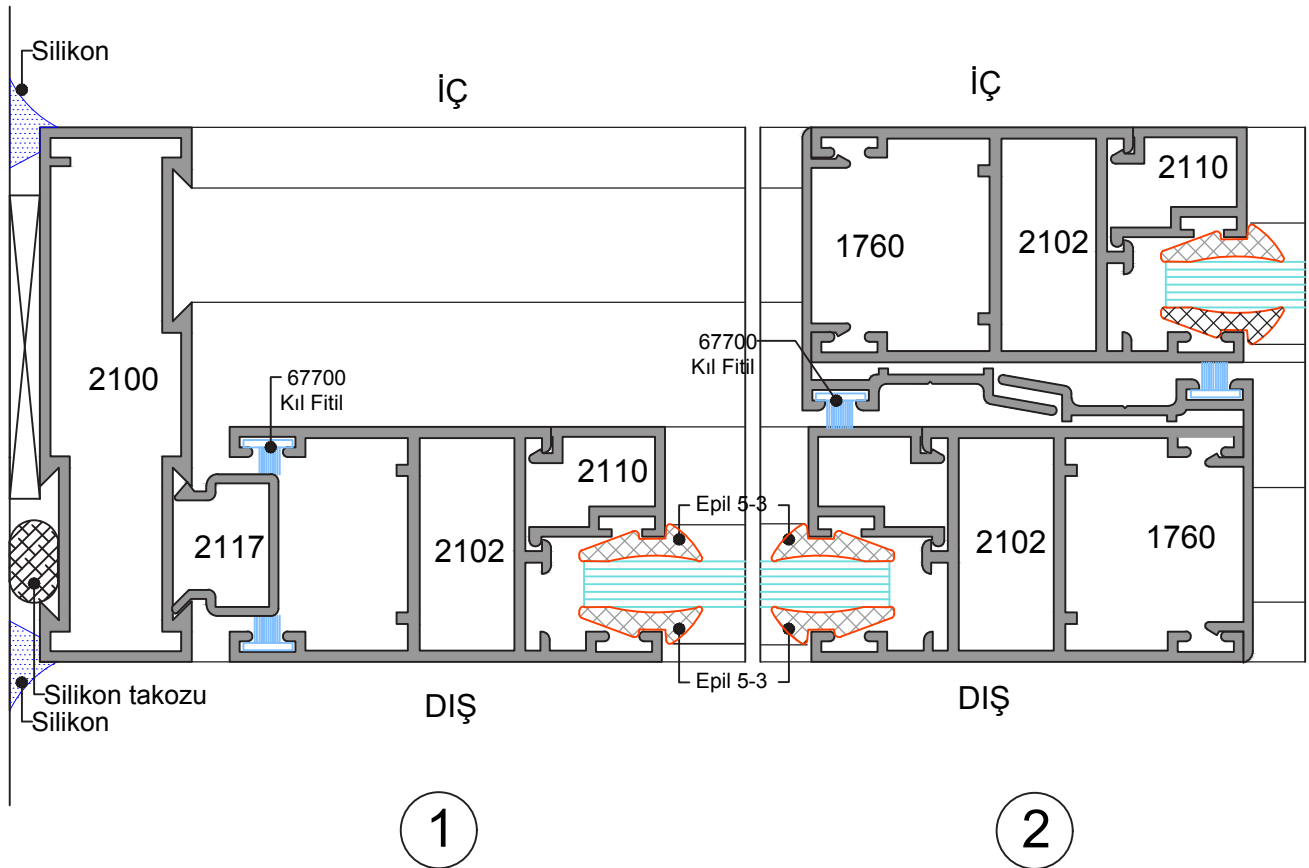
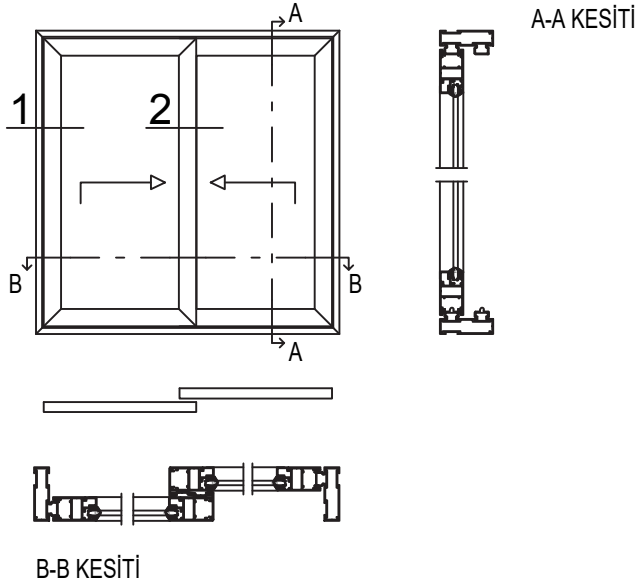

★ Yandaki profil birim ağırlıkları, bilgisayarla hesaplanmış teorik ağırlıklardır.

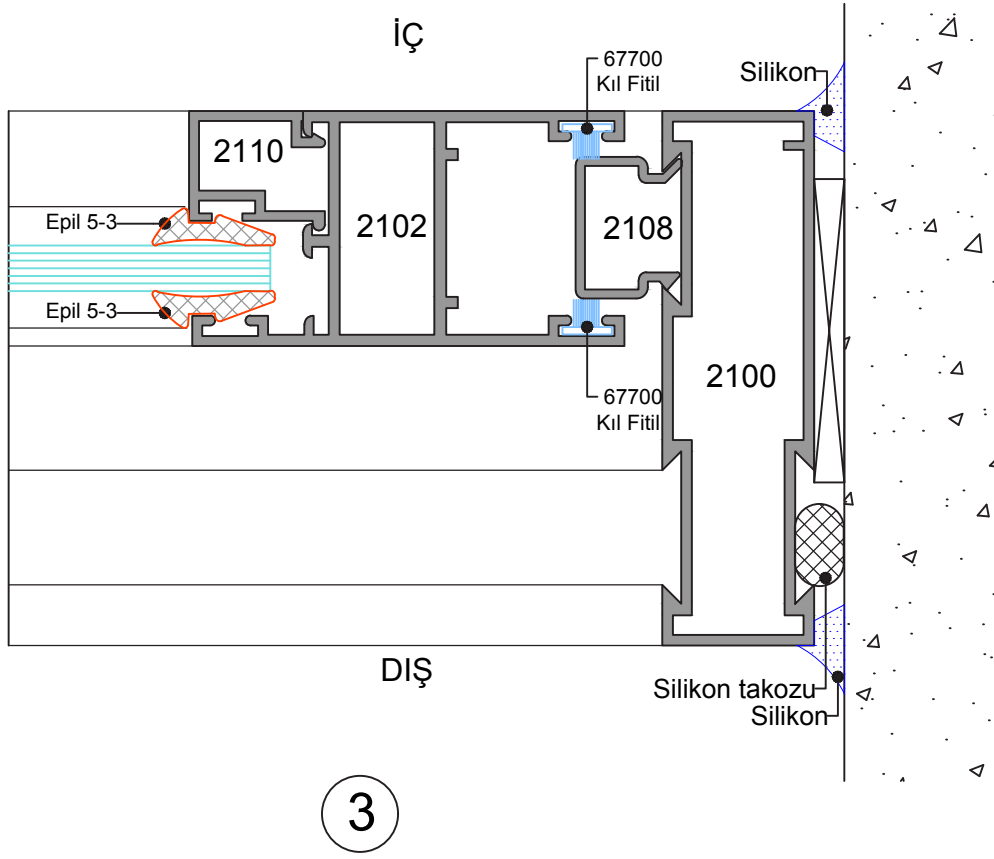
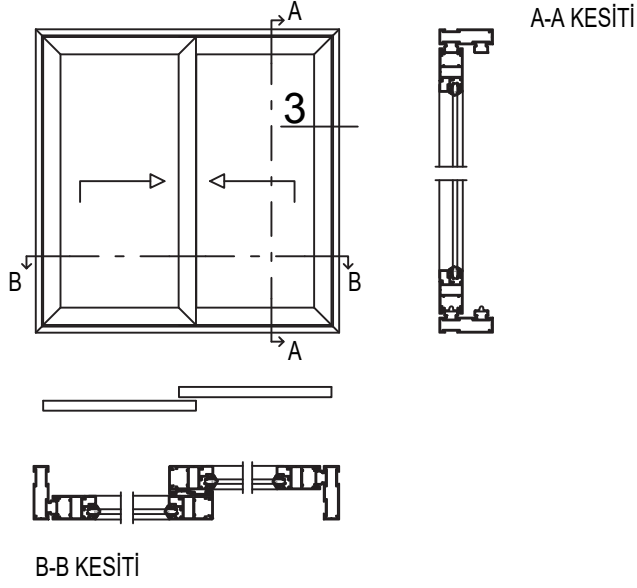





## PROFİL KATALOĐU









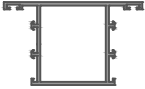
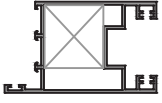

# GENİŐ TUBA SERİSİ

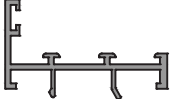
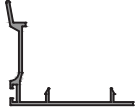
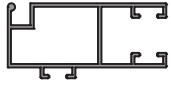
## SLIDING WINDOWS SERIE



★ Profil Ađırlıkları Teorik Olup Teslim Anındaki Ađırlık Geerlidir

★ *Weight of profiles are theoretical, net weight will valid at the time of delivery.*

★ Yandaki profil birim ağırlıkları, bilgisayarda hesaplanmış teorik ağırlıklardır.

PROFİL KESİTİ	PROFİL KODU	PROFİL ADI	AĞIRLIK	ATALET MOMENTLERİ		SAYFA NO
				$J_x$ (cm <sup>4</sup> )	$J_y$ (cm <sup>4</sup> )	
	2116	Kasa Profili	1,243 kg/m	52,66	7,05	
	1770	Orta Kayıt Profili	1,110 kg/m	15,68	12,49	
	2119	Kanat Profili	1,209 kg/m	21,48	13,33	
	2104	Sineklik Kanat Profili	0,713 kg/m	7,05	1,27	
	2127	Adaptör Profili	0,450 kg/m	4,28	0,45	
	2125	Kenet Adaptör Profili	0,433 kg/m	5,42	1,35	
	1843	Sürme Sineklik Profili	0,360 kg/m	2,34	0,65	
	2126	Orta Kenet Profili	0,298 kg/m	1,50	0,15	
	2117	Alt Ray	0,281 kg/m	0,56	0,29	
	2118	Üst Ray	0,219 kg/m	0,61	0,15	
	2132	Çiftli Ray	1,056 kg/m	30,09	1,20	
	2788	Sineklik Rayı	0,325 kg/m	2,48	0,11	
	2108	Sineklik Çıtası	0,137 kg/m	...	...	
	2110	Tek Cam Çıtası	0,191 kg/m	...	...	

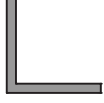
★ Yandaki profil birim ağırlıkları, bilgisayarla hesaplanmış teorik ağırlıklardır.

PROFİL KESİTİ	PROFİL KODU	PROFİL ADI	AĞIRLIK	ATALET MOMENTLERİ		SAYFA NO
				$J_x$ (cm <sup>4</sup> )	$J_y$ (cm <sup>4</sup> )	
	2128	Tek Cam Çıtası	0,260 kg/m	...	...	
	1114	Tuba Bağlantı	0,824 kg/m	...	...	
	2431	Köşe Takozu	4,775 kg/m	...	...	
	2432	Köşe Takozu	1,648 kg/m	...	...	

★ Yandaki profil birim ağırlıkları, bilgisayarla hesaplanmış teorik ağırlıklardır.

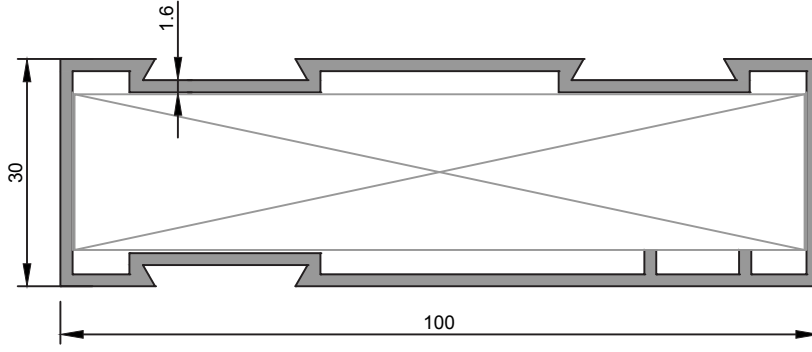

<b>2116</b>
Kasa Profili
1,243 kg/m
$Jx=52,66 \text{ cm}^4$ $Jy=7,05 \text{ cm}^4$

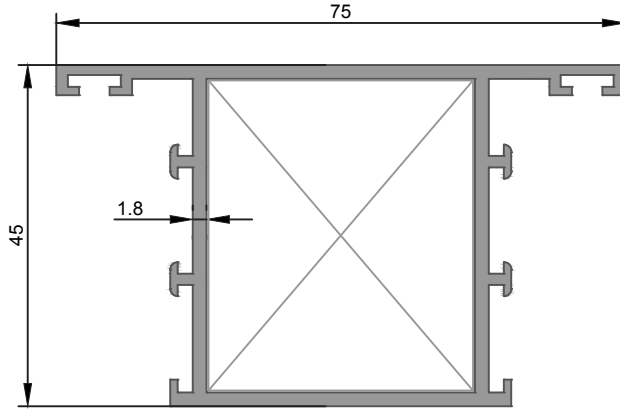

<b>1770</b>
Orta Kayıt Profili
1,110 kg/m
$Jx=15,68 \text{ cm}^4$ $Jy=12,49 \text{ cm}^4$

★ Yandaki profil birim ağırlıkları, bilgisayarla hesaplanmış teorik ağırlıklardır.

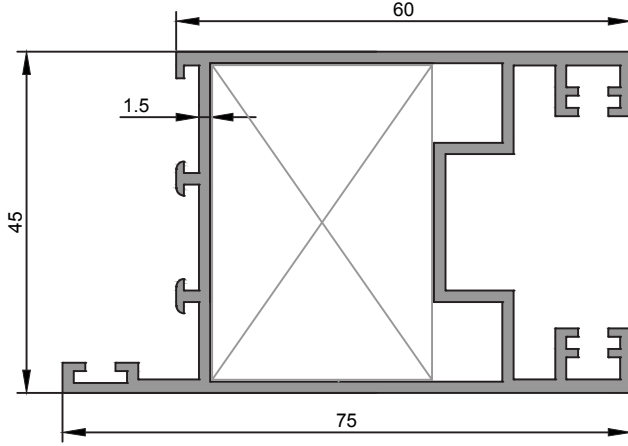

<b>2119</b>
Kanat Profili
1,209 kg/m
Jx=21,48 cm <sup>4</sup> Jy=13,33 cm <sup>4</sup>

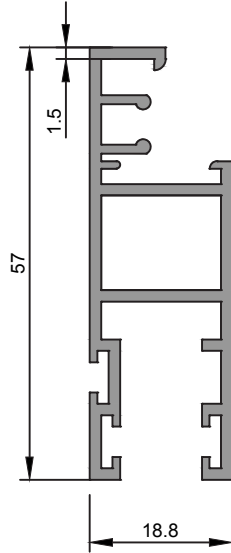

<b>2104</b>
Sineklik Kanat Profili
0,713 kg/m
Jx=7,05 cm <sup>4</sup> Jy=1,27 cm <sup>4</sup>

★ Yandaki profil birim ağırlıkları, bilgisayarla hesaplanmış teorik ağırlıklardır.

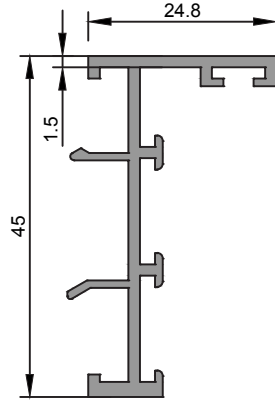

<b>2127</b>
Adaptör Profili
0,450 kg/m
$J_x=4,28 \text{ cm}^4$ $J_y=0,45 \text{ cm}^4$

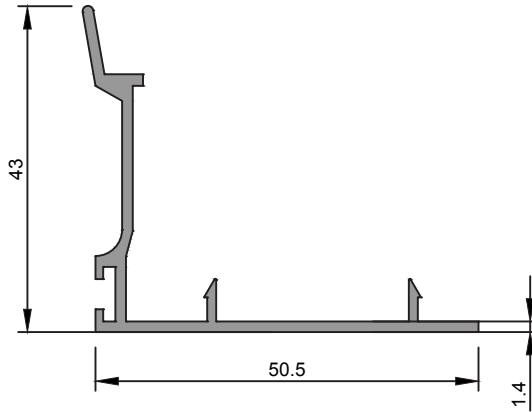

<b>2125</b>
Kenet Adaptörü
0,433 kg/m
$J_x=5,42 \text{ cm}^4$ $J_y=1,35 \text{ cm}^4$

★ Yandaki profil birim ağırlıkları, bilgisayarda hesaplanmış teorik ağırlıklardır.

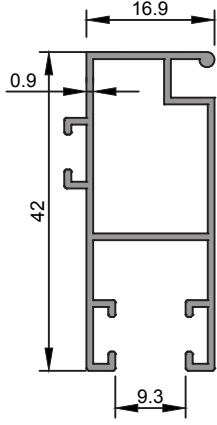

<b>1843</b>
Sürme Sineklik Profili
0,360 kg/m
Jx=2,34 cm <sup>4</sup> Jy=0,65 cm <sup>4</sup>

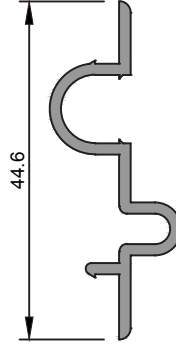

<b>2126</b>
Orta Kenet Profili
0,298 kg/m
Jx=1,50 cm <sup>4</sup> Jy=0,15 cm <sup>4</sup>

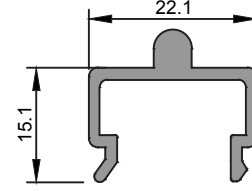

<b>2117</b>
Alt Ray
0,281 kg/m
Jx=0,56 cm <sup>4</sup> Jy=0,29 cm <sup>4</sup>

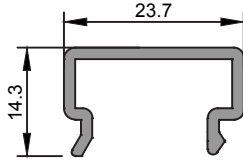

<b>2118</b>
Üst Ray
0,219 kg/m
Jx=0,61 cm <sup>4</sup> Jy=0,15 cm <sup>4</sup>

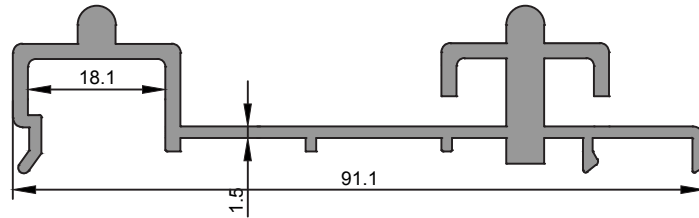

<b>2132</b>
Çiftli Ray
1,056 kg/m
Jx=30,09 cm <sup>4</sup> Jy=1,20 cm <sup>4</sup>

★ Yandaki profil birim ağırlıkları, bilgisayarda hesaplanmış teorik ağırlıklardır.

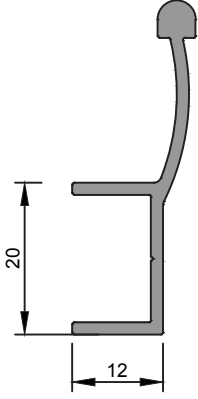

<b>2788</b>
Sineklik Rayı
0,325 kg/m
Jx=2,48 cm <sup>4</sup> Jy=0,11 cm <sup>4</sup>

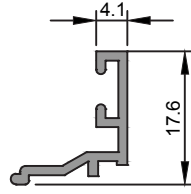

<b>2108</b>
Sineklik Çıtası
0,137 kg/m

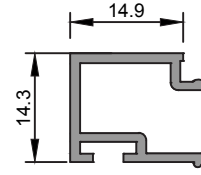

<b>2110</b>
Tek Cam Çıtası
0,191 kg/m

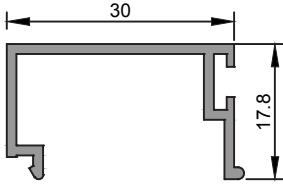

<b>2128</b>
Tek Cam Çıtası
0,260 kg/m

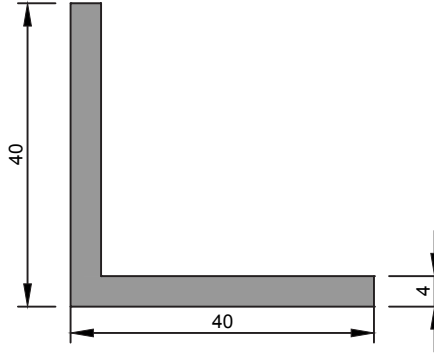

<b>1114</b>
Tuba Bağlantı
0,824 kg/m

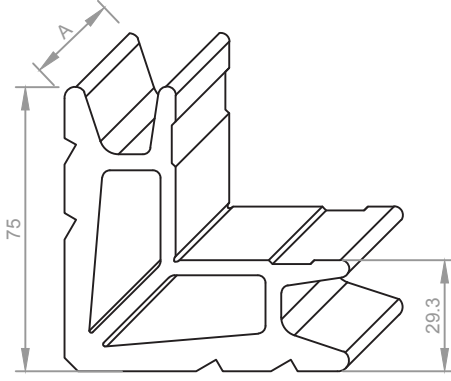

**KÖŞE TAKOZU KESİM ÖLÇÜLERİ****2431**

Köşe Takozu

4,775 kg/m

Aksesuar Kodu	Profil Kodu	Kesim Ölçüsü A(mm)
K2431 415	2119	41.5

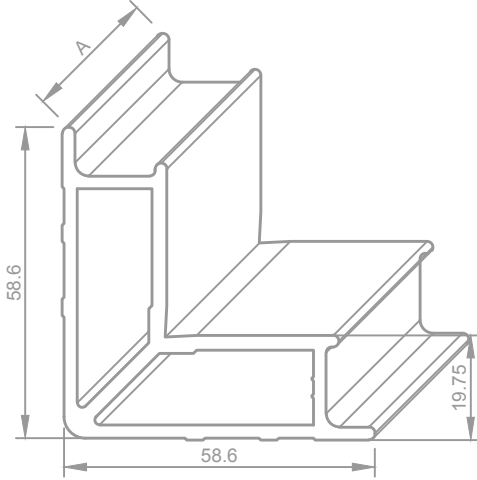
**2432**

Köşe Takozu

1,648 kg/m

Aksesuar Kodu	Profil Kodu	Kesim Ölçüsü A(mm)
K2432 963	2116	96.3

★ Yandaki profil birim ağırlıkları, bilgisayararda hesaplanmış teorik ağırlıklardır.

★ Yandaki profil birim ağırlıkları, bilgisayarla hesaplanmış teorik ağırlıklardır.

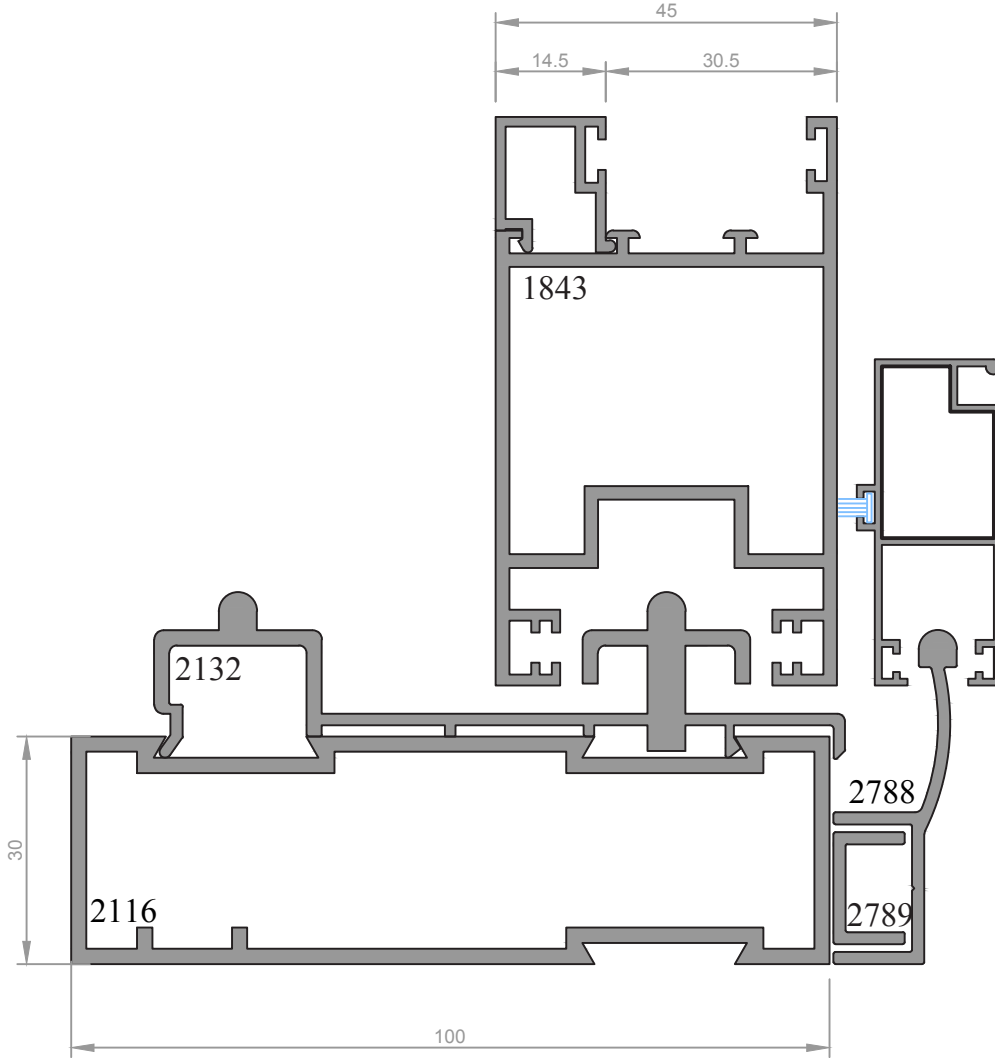



## PROFİL KATALOĐU







# VERANDA PROFİLLERİ

## VERANDA PROFILES

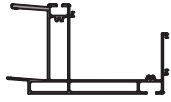
★ Profil Ağırlıkları Teorik Olup Teslim Anındaki Ağırlık Geçerlidir

★ *Weight of profiles are theoretical, net weight will valid at the time of delivery.*

★ Yandaki profil birim ağırlıkları, bilgisayarda hesaplanmış teorik ağırlıklardır.

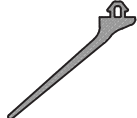
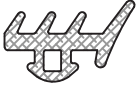
PROFİL KESİTİ	PROFİL KODU	PROFİL ADI	AĞIRLIK	ATALET MOMENTLERİ		SAYFA NO
				$J_x$ (cm <sup>4</sup> )	$J_y$ (cm <sup>4</sup> )	
	4089	Oluk Profili	3,812 kg/m	407,26	137,52	
	4084	Dikme Profili	4,060 kg/m	383,39	383,39	
	4086	Duvar Profili	2,623 kg/m	24,30	19,91	
	4085	Taşıyıcı Profil	2,699 kg/m	122,17	31,78	
	4087	Veranda Profili	0,462 kg/m	15,21	0,11	
	4088	Taşıyıcı Kapak Profili	0,640 kg/m	12,39	3,19	
	4090	Oluk Kapak Profili	1,523 kg/m	136,56	1,04	
	HL60	Fitil	283 gr/m	...	...	
	HL61	Dış Cam Fitili	93 gr/m	...	...	

★ Yandaki profil birim ağırlıkları, bilgisayarla hesaplanmış teorik ağırlıklardır.

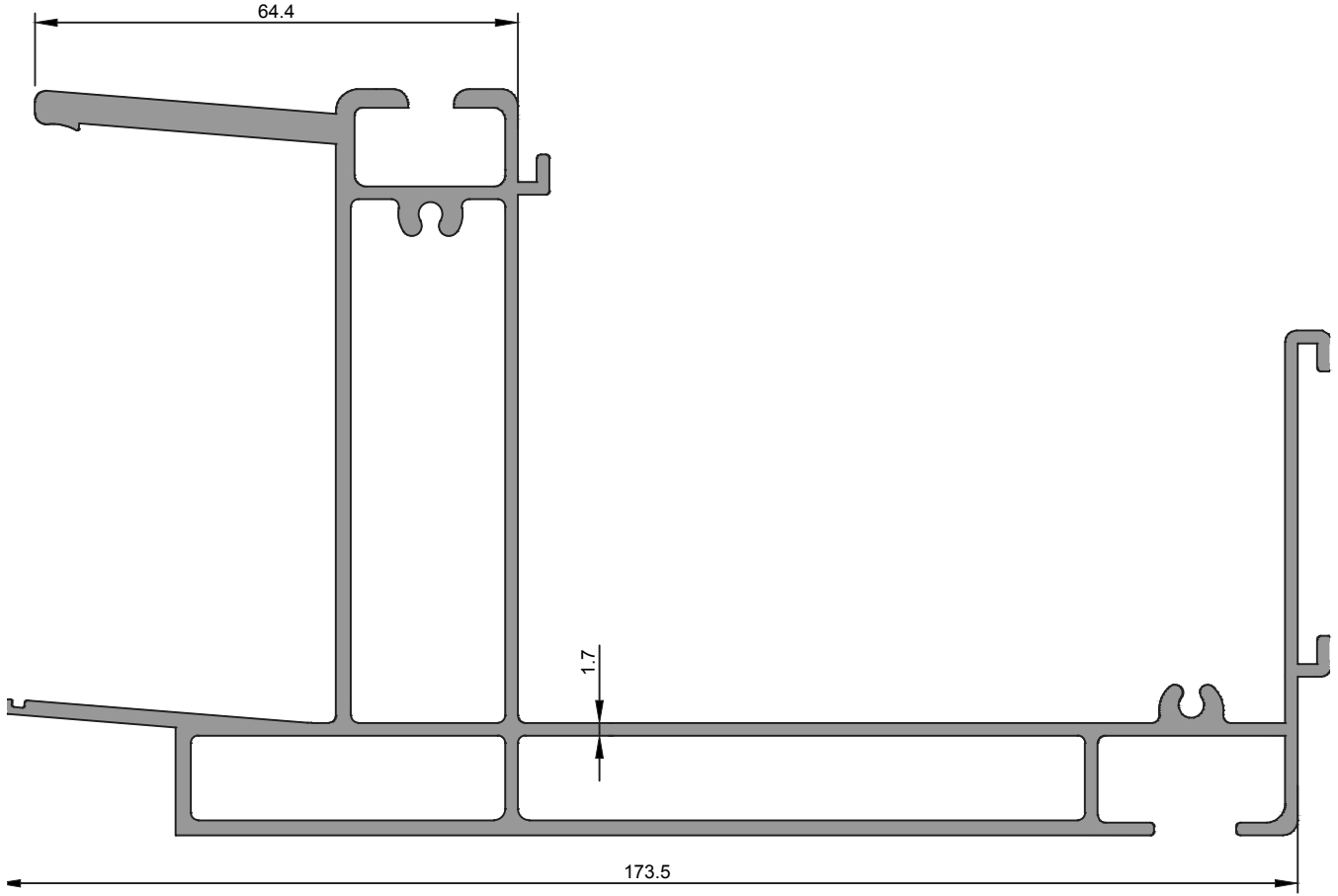

<b>4089</b>
Oluk Profili
3,812 kg/m
Jx=407,26 cm <sup>4</sup> Jy=137,52cm <sup>4</sup>

★ Yandaki profil birim ağırlıkları, bilgisayarla hesaplanmış teorik ağırlıklardır.

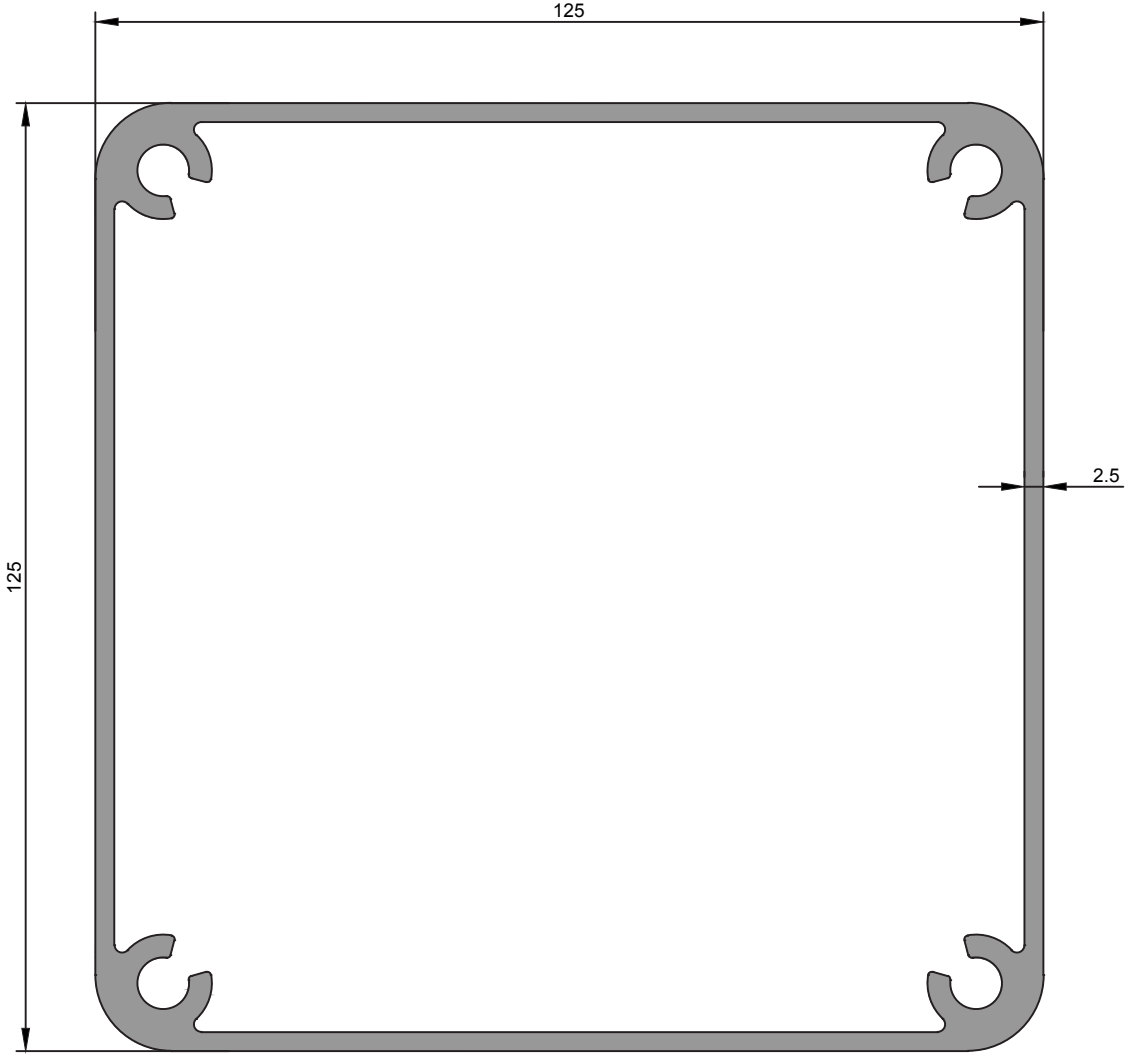

<b>4084</b>
Dikme Profili
4,060 kg/m
$J_x=383,39 \text{ cm}^4$ $J_y=383,39 \text{ cm}^4$

★ Yandaki profil birim ağırlıkları, bilgisayarda hesaplanmış teorik ağırlıklardır.

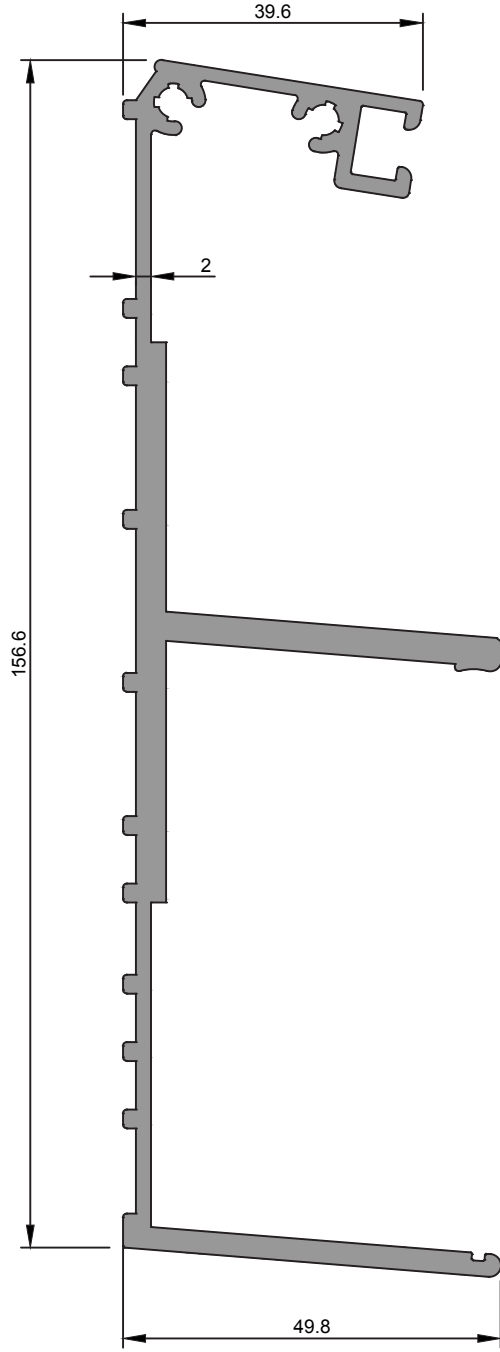

<b>4086</b>
Duvar Profili
2,623 kg/m
$J_x=24,30 \text{ cm}^4$ $J_y=19,91 \text{ cm}^4$

★ Yandaki profil birim ağırlıkları, bilgisayarda hesaplanmış teorik ağırlıklardır.

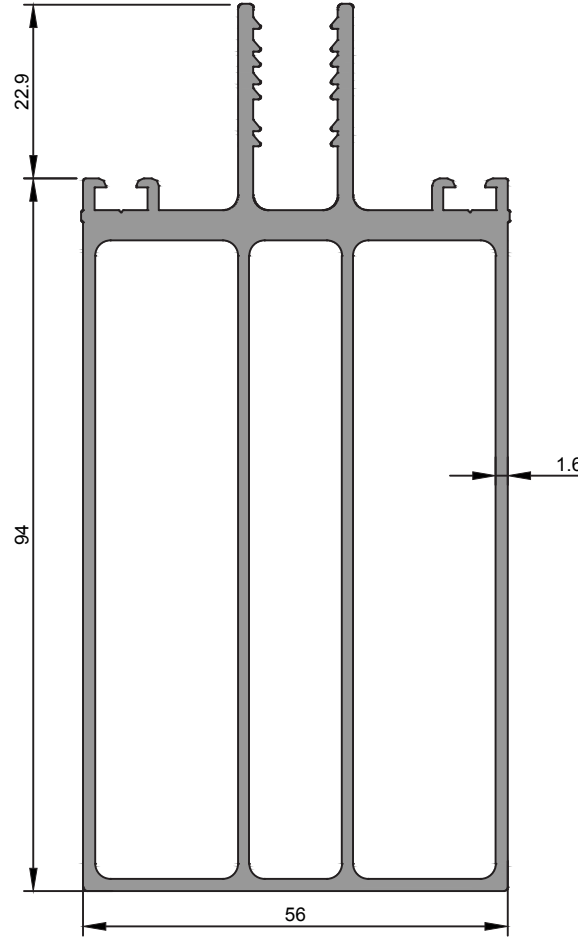

<b>4085</b>
Taşıyıcı Profili
2,699 kg/m
$J_x=122,17 \text{ cm}^4$ $J_y=31,78 \text{ cm}^4$



★ Yandaki profil birim ağırlıkları, bilgisayarla hesaplanmış teorik ağırlıklardır.

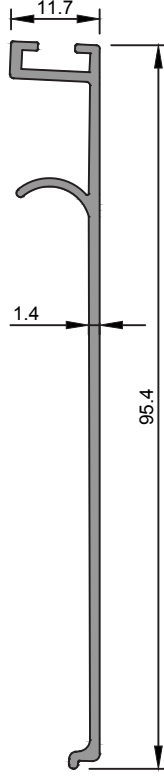

<b>4087</b>
Veranda Profili
0,462 kg/m
$J_x=15,21 \text{ cm}^4$ $J_y=0,11 \text{ cm}^4$

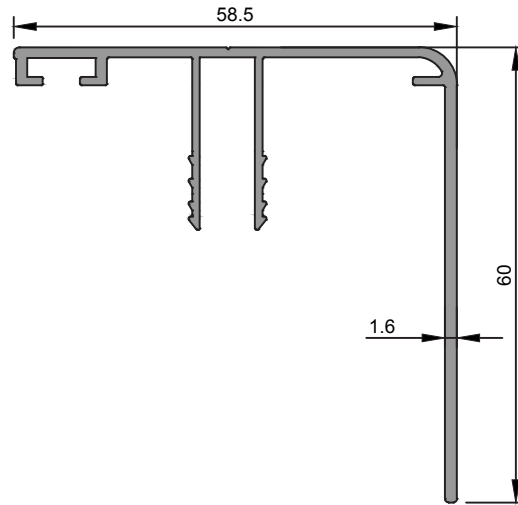

<b>4088</b>
Taşıyıcı Kapak Profili
0,640 kg/m
$J_x=12,39 \text{ cm}^4$ $J_y=3,19 \text{ cm}^4$

★ Yandaki profil birim ağırlıkları, bilgisayarla hesaplanmış teorik ağırlıklardır.





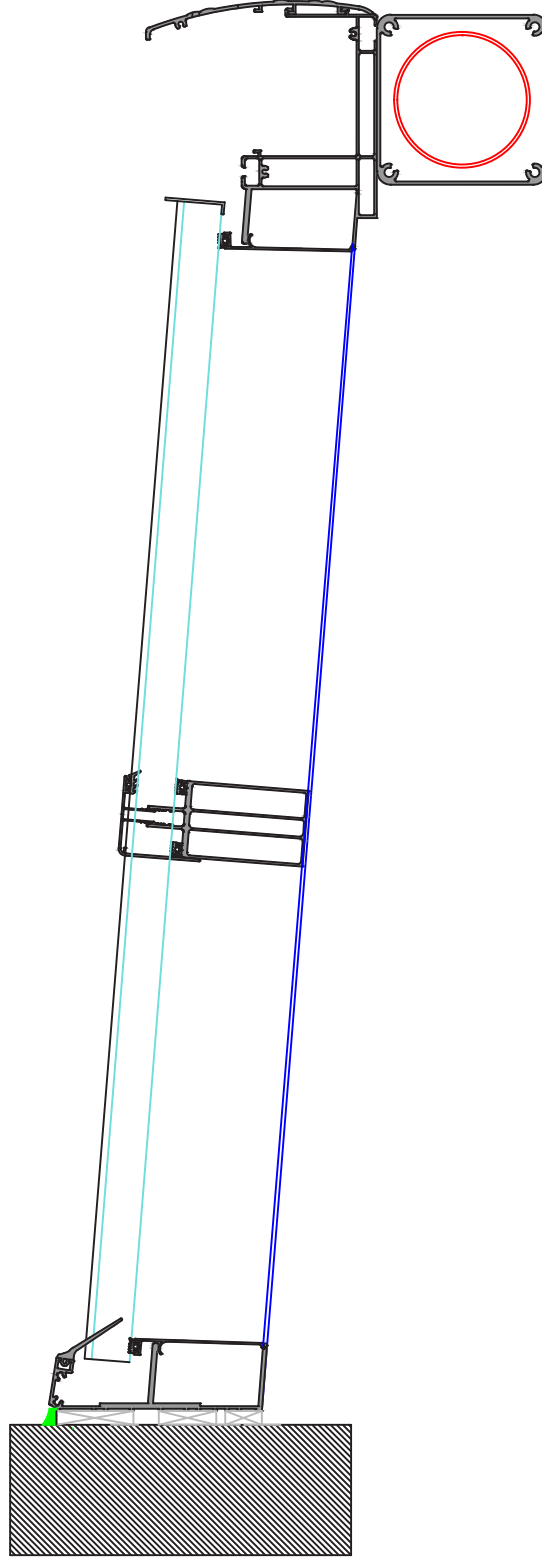

<b>4090</b>
Oluk Kapak Profili
1,523 kg/m
$J_x=136,56 \text{ cm}^4$ $J_y=1,04 \text{ cm}^4$

★ Yandaki profil birim ağırlıkları, bilgisayarda hesaplanmış teorik ağırlıklardır.

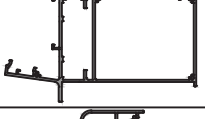
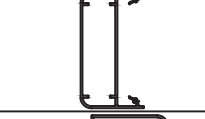
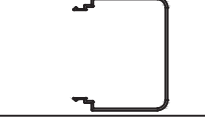

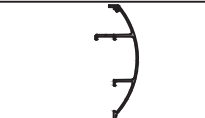
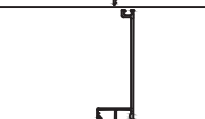
★ Yandaki profil birim ağırlıkları, bilgisayarda hesaplanmış teorik ağırlıklardır.

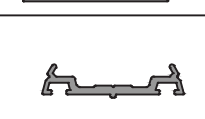
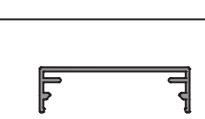
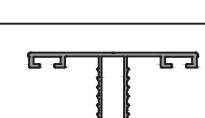
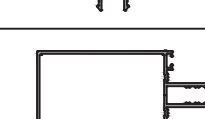
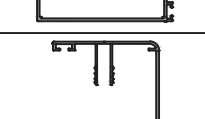
PROFİL KESİTİ	PROFİL KODU	PROFİL ADI	AĞIRLIK	ATALET MOMENTLERİ		SAYFA NO
				$J_x$ (cm <sup>4</sup> )	$J_y$ (cm <sup>4</sup> )	
	4393	Oluk Profili	4,176 kg/m	523,36	167,84	
	4436	Dikme Profili	2,013 kg/m	125,32	25,42	
	4435	Dikme Kapak Profili	1,606 kg/m	122,77	55,84	
	4439	Duvar Profili	2,386 kg/m	378,37	41,58	
	4437	Oluk Kapak Profili	1,250kg/m	60,92	5,79	
	4438	Veranda Profili	0767 kg/m	28,68	1,70	
	2972	86'lık Yatay Taşıyıcı Profili	1,643 kg/m	73,83	21,32	
	2019	Kapak Altı Profili	0,430 kg/m	...	...	
	2020	Kapak Profili	0,333 kg/m	...	...	
	3325	Taşıyıcı Kapak Profili	0,428 kg/m	...	...	
	4504	Taşıyıcı Profil	1,672 kg/m	79,60	27,16	
	4088	Taşıyıcı Kapak Profili	0,640 kg/m	...	...	



★ Yandaki profil birim ağırlıkları, bilgisayarda hesaplanmış teorik ağırlıklardır.

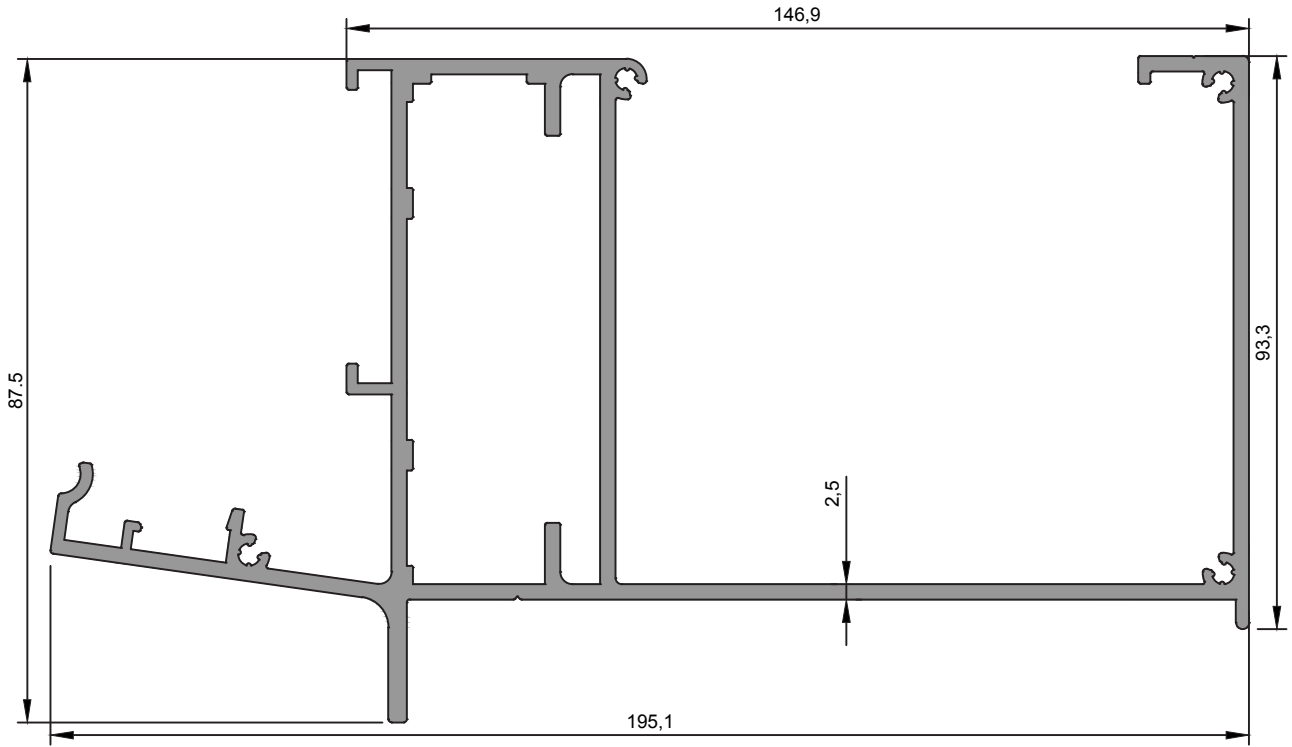

<b>4393</b>
Oluk Profili
4,176 kg/m
Jx=523,36 cm <sup>4</sup> Jy=167,84cm <sup>4</sup>

★ Yandaki profil birim ağırlıkları, bilgisayararda hesaplanmış teorik ağırlıklardır.

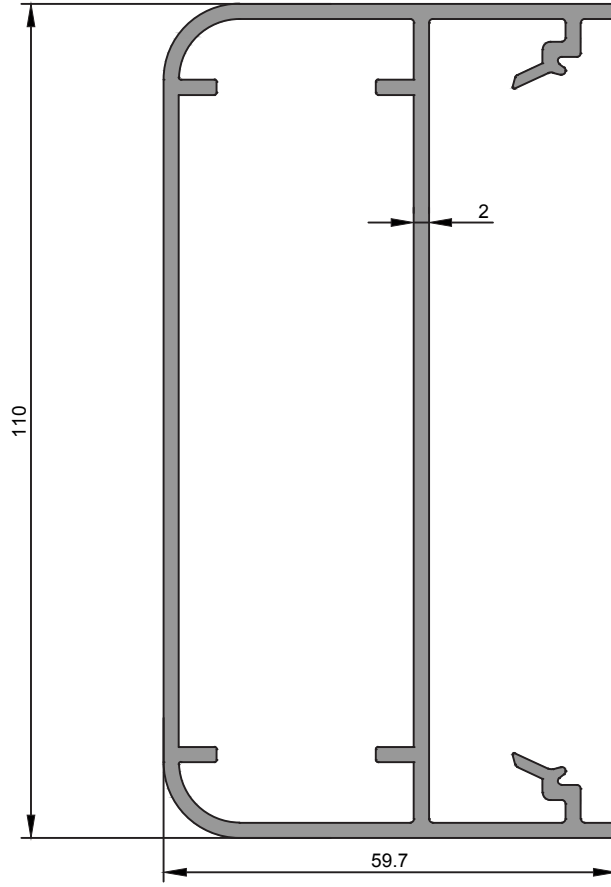

<b>4436</b>
Dikme Profili
2,013 kg/m
$J_x=125,32 \text{ cm}^4$ $J_y=25,42 \text{ cm}^4$

★ Yandaki profil birim ağırlıkları, bilgisayarla hesaplanmış teorik ağırlıklardır.

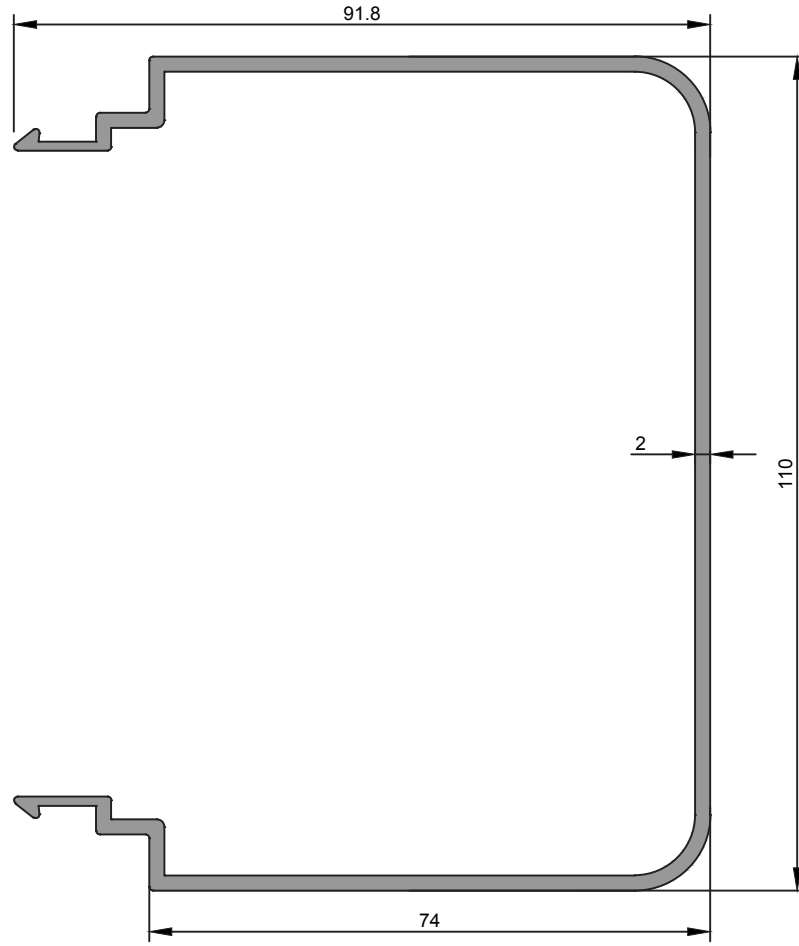

<b>4435</b>
Dikme Kapak Profili
1,606 kg/m
$J_x=122,77 \text{ cm}^4$ $J_y=55,84 \text{ cm}^4$



★ Yandaki profil birim ağırlıkları, bilgisayarla hesaplanmış teorik ağırlıklardır.

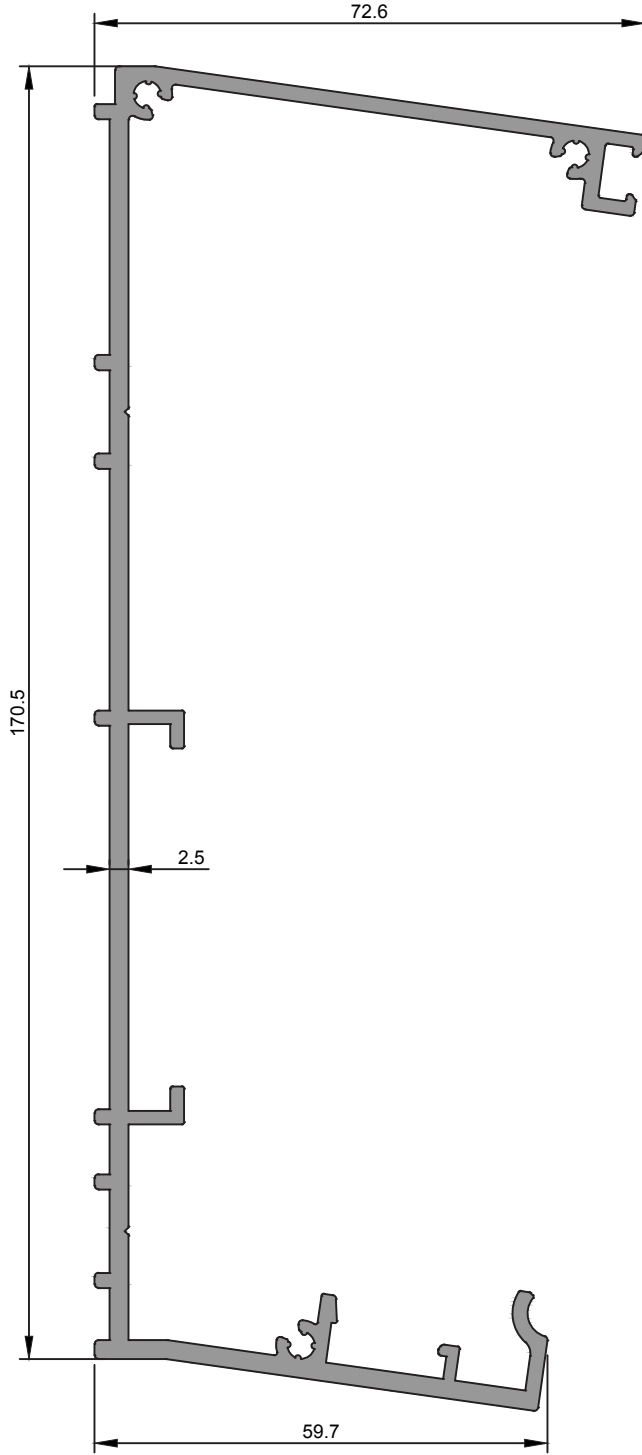

<b>4439</b>
Duvar Profili
2,386 kg/m
$J_x=378,37 \text{ cm}^4$ $J_y=41,58 \text{ cm}^4$

★ Yandaki profil birim ağırlıkları, bilgisayarla hesaplanmış teorik ağırlıklardır.

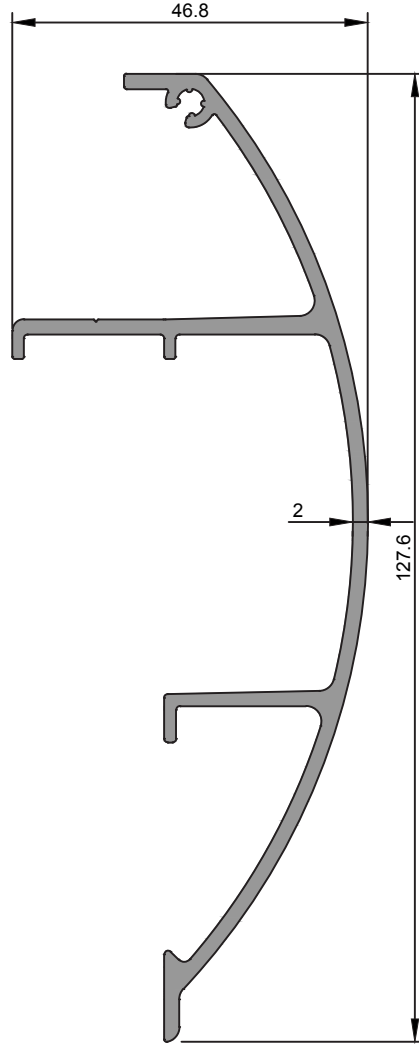

<b>4437</b>
Oluk Kapak Profili
1,250 kg/m
$J_x=60,92 \text{ cm}^4$ $J_y=5,79 \text{ cm}^4$

★ Yandaki profil birim ağırlıkları, bilgisayararda hesaplanmış teorik ağırlıklardır.

**4438**

Veranda Profili

0,767 kg/m

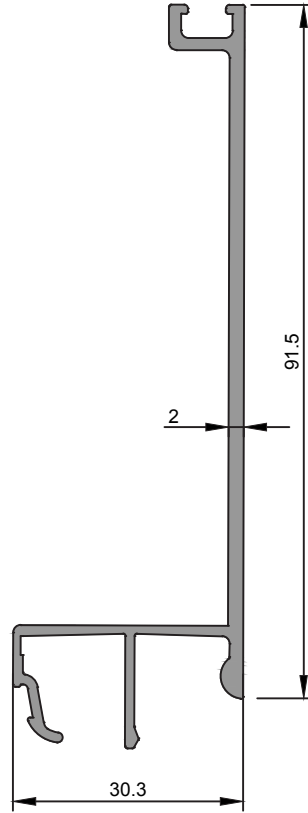
 $J_x=28,68 \text{ cm}^4 J_y=1,70 \text{ cm}^4$ 

★ Yandaki profil birim ağırlıkları, bilgisayarda hesaplanmış teorik ağırlıklardır.

<b>2972</b>
Yatay Taşıyıcı Profil (86)
1,643 kg/m
$J_x=73,83 \text{ cm}^4$ $J_y=21,32 \text{ cm}^4$

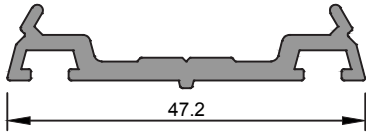
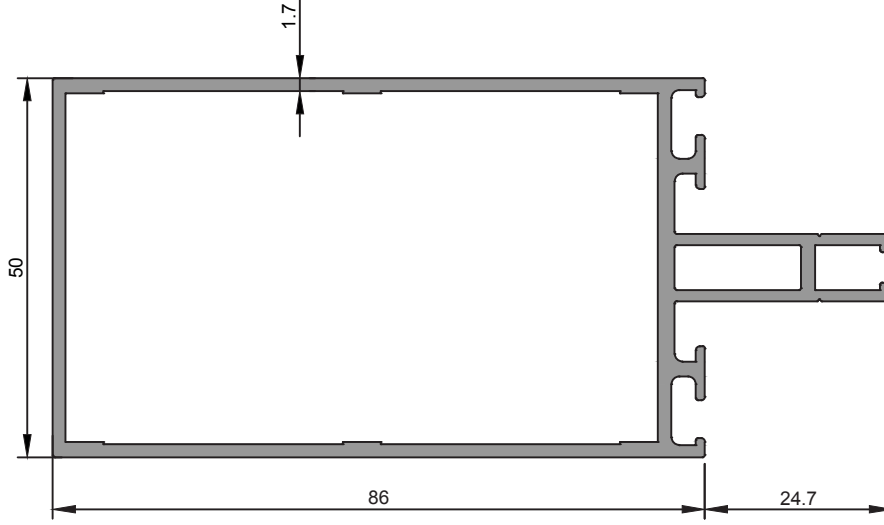

<b>2019</b>
Kapak Altı Profili
0,430 kg/m

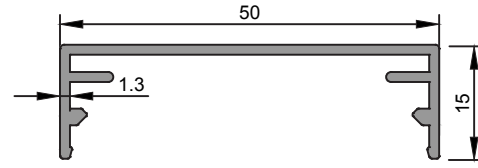

<b>2020</b>
Kapak Profili
0,333 kg/m

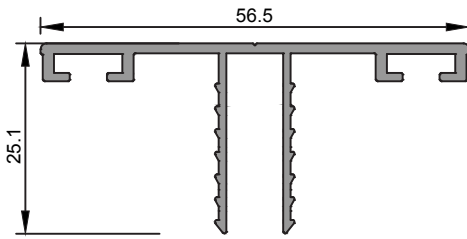

<b>3325</b>
Veranda Profili
0,428 kg/m

★ Yandaki profil birim ağırlıkları, bilgisayarda hesaplanmış teorik ağırlıklardır.

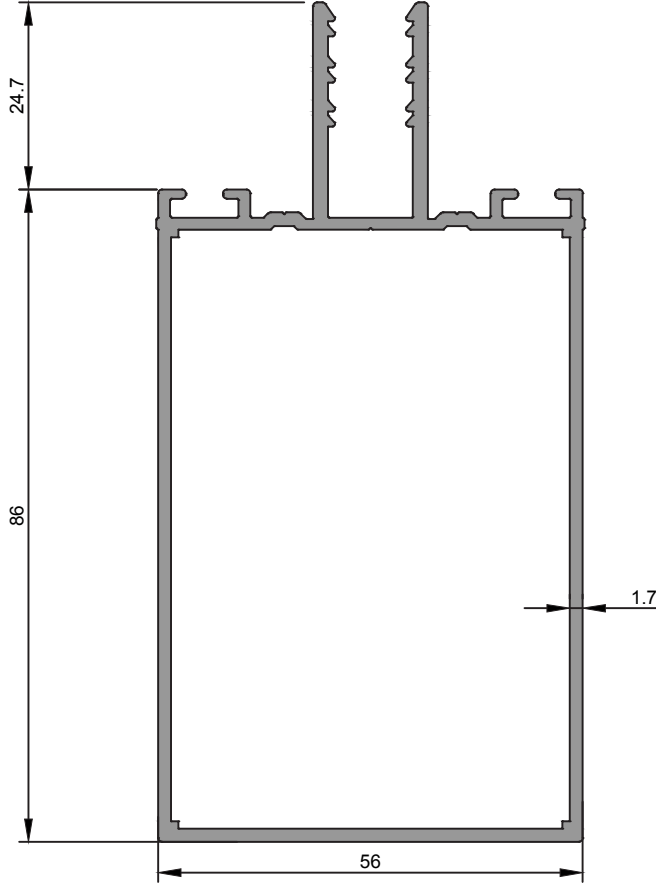

<b>4504</b>
Taşıyıcı Profil(86)
1,672 kg/m
Jx=79,60 cm <sup>4</sup> Jy=27,16 cm <sup>4</sup>

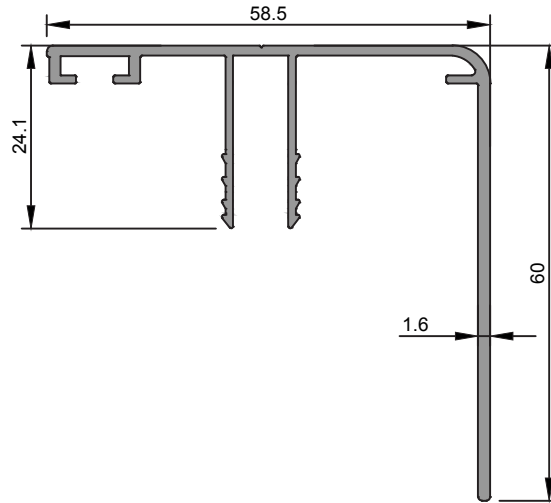

<b>4088</b>
Veranda Profili
0,640 kg/m
Jx=12,39 cm <sup>4</sup> Jy=3,19 cm <sup>4</sup>

★ Yandaki profil birim ağırlıkları, bilgisayarda hesaplanmış teorik ağırlıklardır.

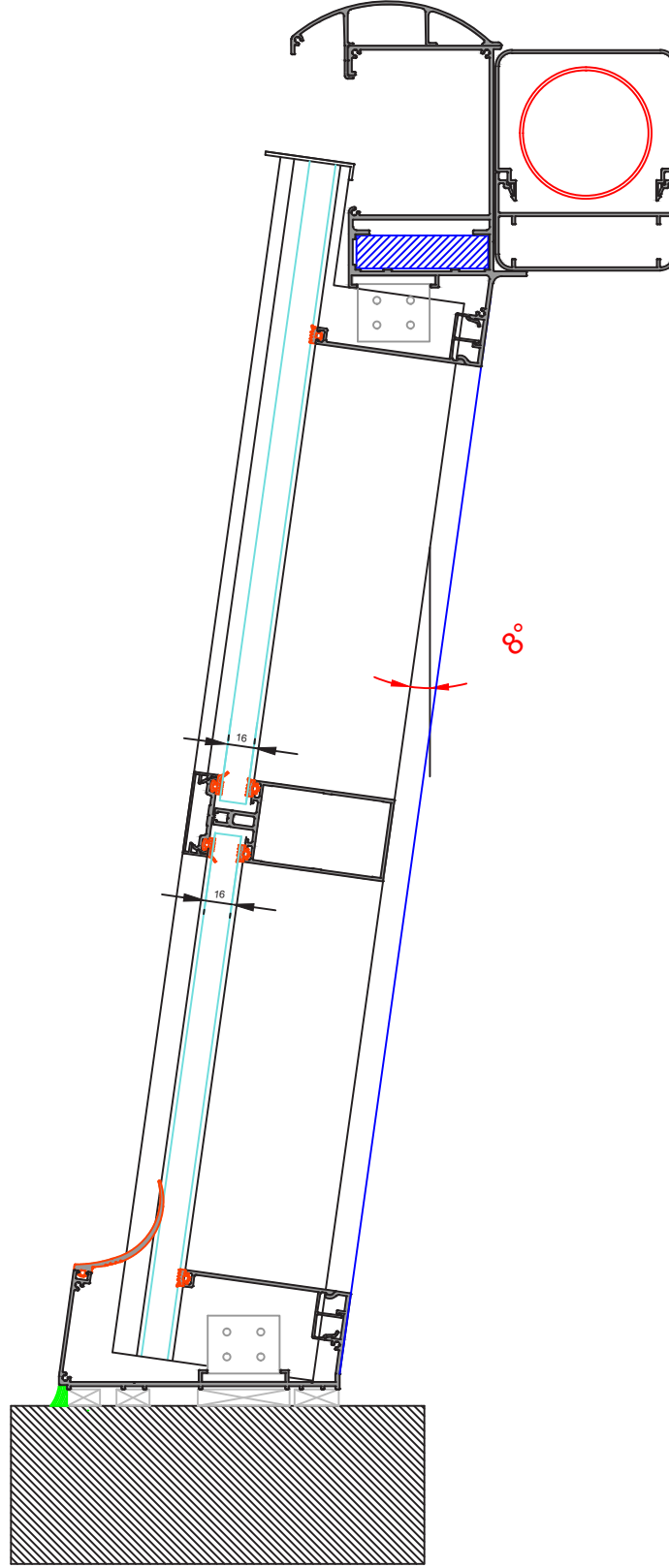



## PROFİL KATALOĐU













# KOMPOZİT PROFİLLERİ

## COMPOSITE PANEL PROFILES

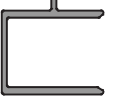
★ Profil Ağırlıkları Teorik Olup Teslim Anındaki Ağırlık Geçerlidir

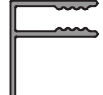
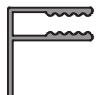
★ *Weight of profiles are theoretical, net weight will valid at the time of delivery.*

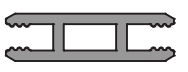
★ Yandaki profil birim ağırlıkları, bilgisayarda hesaplanmış teorik ağırlıklardır.

PROFİL KESİTİ	PROFİL KODU	PROFİL ADI	AĞIRLIK	ATALET MOMENTLERİ		SAYFA NO
				$J_x$ (cm <sup>4</sup> )	$J_y$ (cm <sup>4</sup> )	
	1337	Kompozit Profili	0,202 kg/m	0,69	0,04	
	1085	Kompozit Profili	0,238 kg/m	0,77	0,05	
	1764	Kompozit Profili	0,233 kg/m	0,79	0,07	
	1243	Kompozit Profili	0,230 kg/m	0,74	0,07	
	1591	Kompozit Profili	0,205 kg/m	0,63	0,08	
	1633	Kompozit Profili	0,169 kg/m	0,37	0,05	
	1851	Kompozit Profili	0,560 kg/m	2,94	1,72	
	1979	Kompozit Profili	0,520 kg/m	4,83	1,29	
	1188	Kompozit Profili	0,217 kg/m	0,44	0,16	
	1907	Kompozit Profili	0,176 kg/m	0,30	0,10	
	1019	Kompozit Profili	0,163 kg/m	0,47	0,08	
	1159	Kompozit Profili	0,403 kg/m	11,58	0,16	
	1193	Kompozit Profili	0,280 kg/m	1,34	0,60	
	1240	Kompozit Profili	0,123 kg/m	0,15	0,03	





★ Yandaki profil birim ağırlıkları, bilgisayarda hesaplanmış teorik ağırlıklardır.

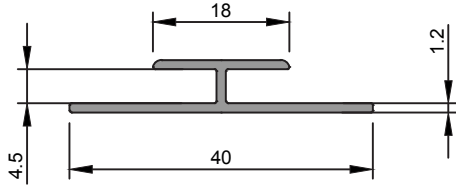

<b>1337</b>
Kompozit Profili
0,202 kg/m
$J_x=0,69 \text{ cm}^4$ $J_y=0,04 \text{ cm}^4$

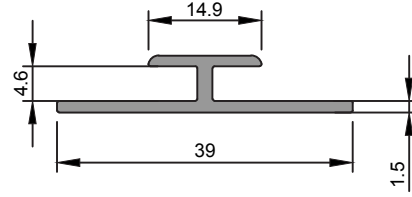

<b>1085</b>
Kompozit Profili
0,238 kg/m
$J_x=0,77 \text{ cm}^4$ $J_y=0,05 \text{ cm}^4$

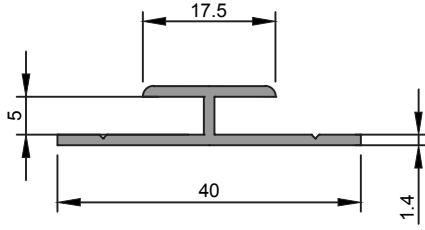

<b>1764</b>
Kompozit Profili
0,233 kg/m
$J_x=0,79 \text{ cm}^4$ $J_y=0,07 \text{ cm}^4$

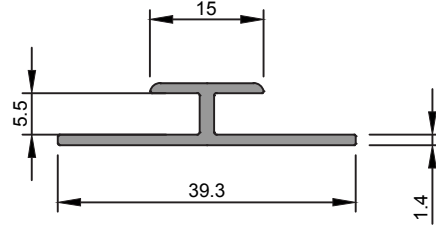

<b>1243</b>
Kompozit Profili
0,230 kg/m
$J_x=0,74 \text{ cm}^4$ $J_y=0,07 \text{ cm}^4$

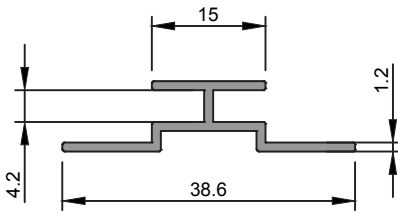

<b>1591</b>
Kompozit Profili
0,205 kg/m
$J_x=0,63 \text{ cm}^4$ $J_y=0,08 \text{ cm}^4$

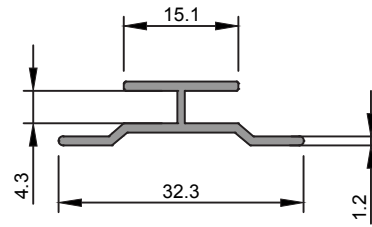

<b>1633</b>
Kompozit Profili
0,169 kg/m
$J_x=0,37 \text{ cm}^4$ $J_y=0,05 \text{ cm}^4$

★ Yandaki profil birim ağırlıkları, bilgisayarda hesaplanmış teorik ağırlıklardır.

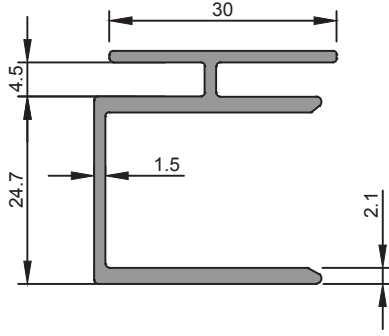

<b>1851</b>
Kompozit Profili
0,560 kg/m
$J_x=2,94 \text{ cm}^4$ $J_y=1,72 \text{ cm}^4$

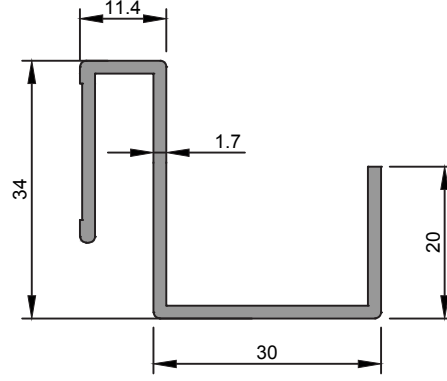

<b>1979</b>
Kompozit Profili
0,520 kg/m
$J_x=4,83 \text{ cm}^4$ $J_y=1,29 \text{ cm}^4$

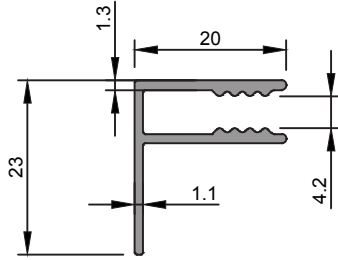

<b>1188</b>
Kompozit Profili
0,217 kg/m
$J_x=0,44 \text{ cm}^4$ $J_y=0,16 \text{ cm}^4$

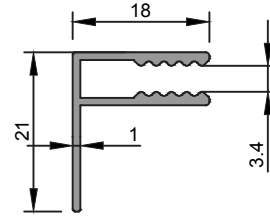

<b>1907</b>
Kompozit Profili
0,176 kg/m
$J_x=0,30 \text{ cm}^4$ $J_y=0,10 \text{ cm}^4$

★ Yandaki profil birim ağırlıkları, bilgisayarla hesaplanmış teorik ağırlıklardır.

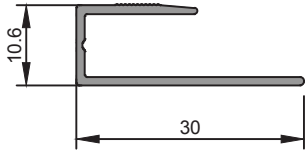

<b>1019</b>
Kompozit Profili
0,163 kg/m
$J_x=0,47 \text{ cm}^4$ $J_y=0,08 \text{ cm}^4$

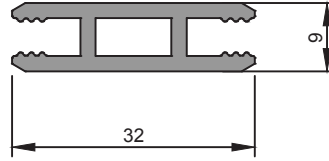

<b>1159</b>
Kompozit Profili
0,403 kg/m
$J_x=11,58 \text{ cm}^4$ $J_y=0,16 \text{ cm}^4$

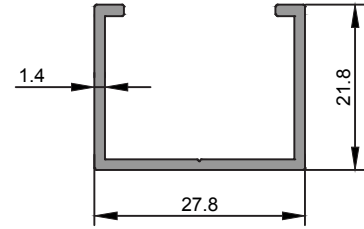

<b>1193</b>
Kompozit Profili
0,280 kg/m
$J_x=1,34 \text{ cm}^4$ $J_y=0,60 \text{ cm}^4$

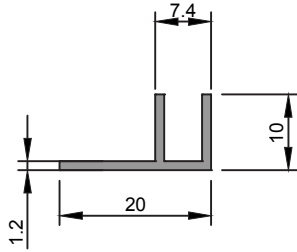

<b>1240</b>
Kompozit Profili
0,123 kg/m
$J_x=0,15 \text{ cm}^4$ $J_y=0,03 \text{ cm}^4$

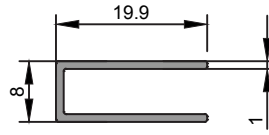

<b>1018</b>
Kompozit Profili
0,123 kg/m
$J_x=0,17 \text{ cm}^4$ $J_y=0,05 \text{ cm}^4$

★ Yandaki profil birim ağırlıkları, bilgisayarda hesaplanmış teorik ağırlıklardır.

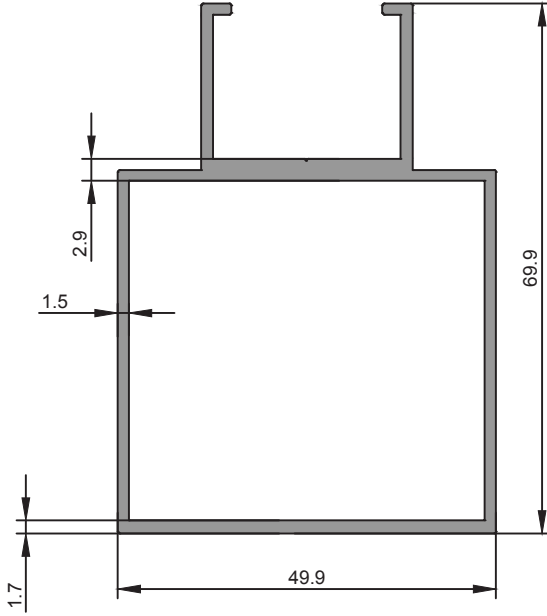

<b>1192</b>
Kompozit Profili
1,093 kg/m
$J_x=20,31 \text{ cm}^4$ $J_y=12,57 \text{ cm}^4$





## PROFİL KATALOĐU













# KÜPEŐTE PROFİLLERİ

## HANDRAILS PROFILES

★ Profil Ađırlıkları Teorik Olup Teslim Anındaki Ađırlık Geerlidir

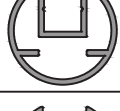

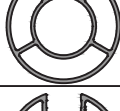







★ *Weight of profiles are theoretical, net weight will valid at the time of delivery.*

★ Yandaki profil birim ağırlıkları, bilgisayarda hesaplanmış teorik ağırlıklardır.









PROFİL KESİTİ	PROFİL KODU	PROFİL ADI	AĞIRLIK	ATALET MOMENTLERİ		SAYFA NO
				$J_x$ (cm <sup>4</sup> )	$J_y$ (cm <sup>4</sup> )	
	1361	40x1,3 Küpeşte Profili	0,815 kg/m	...	...	
	1020	40x1,6 Küpeşte Profili	0,912 kg/m	...	...	
	1251	40x2 Küpeşte Profili	1,064 kg/m	...	...	
	1021	40x1,5 Küpeşte Profili	0,870 kg/m	...	...	
	2052	40x1,5 Küpeşte Profili	0,700 kg/m	...	...	
	1359	40x1,6 Küpeşte Profili	0,688 kg/m	...	...	
	1014	40x1,6 Küpeşte Profili	0,780 kg/m	...	...	
	1314	39,2x1,7 Küpeşte Profili	0,893 kg/m	...	...	
	1690	50,3x1,6 Küpeşte Profili	0,935 kg/m	...	...	
	1194	30x1,5 Küpeşte Profili	0,519 kg/m	...	...	
	1252	30x1,8 Küpeşte Profili	0,672 kg/m	...	...	
	2014	40x1,3 Küpeşte Profili	0,781 kg/m	...	...	
	2095	40x1,3 Küpeşte Profili	0,780 kg/m	...	...	
	1169	40x2 Küpeşte Profili	0,647 kg/m	...	...	





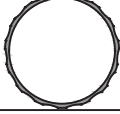
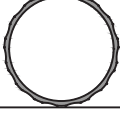
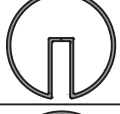
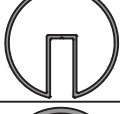

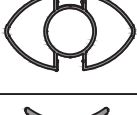
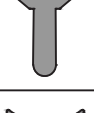

★ Yandaki profil birim ağırlıkları, bilgisayarda hesaplanmış teorik ağırlıklardır.

PROFİL KESİTİ	PROFİL KODU	PROFİL ADI	AĞIRLIK	ATALET MOMENTLERİ		SAYFA NO
				$J_x$ (cm <sup>4</sup> )	$J_y$ (cm <sup>4</sup> )	
	1926	40x2,5 Küpeşte Profili	0,798 kg/m	...	...	
	2640	35x1,3 Küpeşte Profili	0,373 kg/m	...	...	
	2641	35x1,5 Küpeşte Profili	0,428 kg/m	...	...	
	2736	35x2 Küpeşte Profili	0,562 kg/m	...	...	
	1064	Kapak Profili	0,060 kg/m	...	...	
	1315	Kapak Profili	0,064 kg/m	...	...	
	2015	Kapak Profili	0,079 kg/m	...	...	
	1191	Kapak Profili	0,085 kg/m	...	...	
	2194	35x1,3 Küpeşte Profili	0,817 kg/m	...	...	
	1173	30x2 Küpeşte Profili	0,477 kg/m	...	...	
	1048	30x3 Küpeşte Profili	0,690 kg/m	...	...	
	2639	19x1 Küpeşte Profili	0,153 kg/m	...	...	
	2519	19x1,2 Küpeşte Profili	0,182 kg/m	...	...	
	1804	16x1 Küpeşte Profili	0,128 kg/m	...	...	





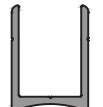
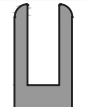
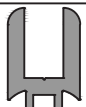
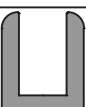

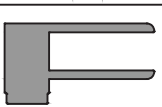
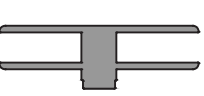
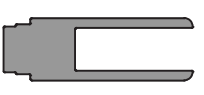
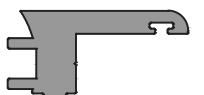
★ Yandaki profil birim ağırlıkları, bilgisayarda hesaplanmış teorik ağırlıklardır.

PROFİL KESİTİ	PROFİL KODU	PROFİL ADI	AĞIRLIK	ATALET MOMENTLERİ		SAYFA NO
				$J_x$ (cm <sup>4</sup> )	$J_y$ (cm <sup>4</sup> )	
	1606	16x1,2 Küpeşte Profili	0,151 kg/m	...	...	
	1063	16x1,5 Küpeşte Profili	0,185 kg/m	...	...	
	1011	16x2 Küpeşte Profili	0,238 kg/m	...	...	
	1308	16x4 Küpeşte Profili	0,409 kg/m	...	...	
	1172	16x5 Küpeşte Profili	0,468 kg/m	...	...	
	1605	Küpeşte Profili	1,043 kg/m	...	...	
	1317	Küpeşte Profili	1,266 kg/m	...	...	
	2055	Küpeşte Profili	0,834 kg/m	...	...	
	2054	Küpeşte Profili	0,832 kg/m	...	...	
	1986	Küpeşte Profili	1,238 kg/m	...	...	
	1985	Küpeşte Profili	1,414 kg/m	...	...	
	2070	Küpeşte Profili	0,770 kg/m	...	...	
	1005	Küpeşte Profili	0,973 kg/m	...	...	
	1162	Küpeşte Profili	1,092 kg/m	...	...	

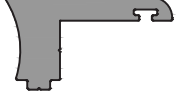

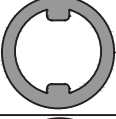
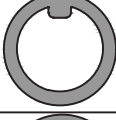
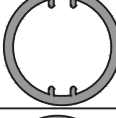
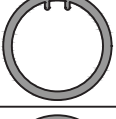
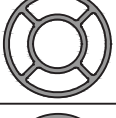
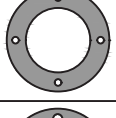
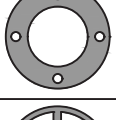
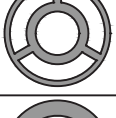

★ Yandaki profil birim ağırlıkları, bilgisayarda hesaplanmış teorik ağırlıklardır.

PROFİL KESİTİ	PROFİL KODU	PROFİL ADI	AĞIRLIK	ATALET MOMENTLERİ		SAYFA NO
				$J_x$ (cm <sup>4</sup> )	$J_y$ (cm <sup>4</sup> )	
	1244	Küpeşte Profili	1,116 kg/m	...	...	
	1819	Küpeşte Profili	0,854 kg/m	...	...	
	1027	Küpeşte Profili	2,365 kg/m	...	...	
	1157	Küpeşte Profili	1,528 kg/m	...	...	
	1286	Küpeşte Profili	3,027 kg/m	...	...	
	1275	Küpeşte Profili	0,240 kg/m	...	...	
	1646	Küpeşte Profili	0,942 kg/m	...	...	
	1007	Küpeşte Profili	0,892 kg/m	...	...	
	1045	Küpeşte Profili	0,709 kg/m	...	...	
	1820	Küpeşte Profili	0,511 kg/m	...	...	
	1023	Küpeşte Profili	1,023 kg/m	...	...	
	1024	Küpeşte Profili	1,367 kg/m	...	...	
	1177	Küpeşte Profili	0,968 kg/m	...	...	
	1070	Küpeşte Profili	0,803 kg/m	...	...	



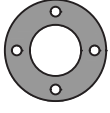

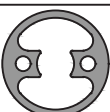
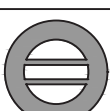
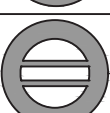
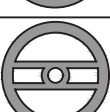
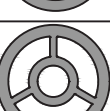
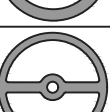

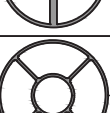
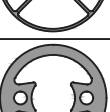
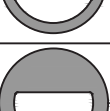



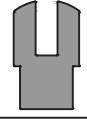

★ Yandaki profil birim ağırlıkları, bilgisayarda hesaplanmış teorik ağırlıklardır.

PROFİL KESİTİ	PROFİL KODU	PROFİL ADI	AĞIRLIK	ATALET MOMENTLERİ		SAYFA NO
				$J_x$ (cm <sup>4</sup> )	$J_y$ (cm <sup>4</sup> )	
	1072	Küpeşte Profili	0,737 kg/m	...	...	
	1071	Küpeşte Profili	0,383 kg/m	...	...	
	1003	Küpeşte Profili	1,508 kg/m	...	...	
	1615	Küpeşte Profili	0,306 kg/m	...	...	
	1163	Küpeşte Profili	0,243 kg/m	...	...	
	1013	Küpeşte Profili	2,649 kg/m	...	...	
	1028	Küpeşte Profili	2,524 kg/m	...	...	
	1818	Küpeşte Profili	1,502 kg/m	...	...	
	1930	Küpeşte Profili	1,465 kg/m	...	...	
	1174	Küpeşte Profili	1,412 kg/m	...	...	
	1000	Küpeşte Profili	8,003 kg/m	...	...	
	1001	Küpeşte Profili	6,648 kg/m	...	...	
	1647	Küpeşte Profili	1,055 kg/m	...	...	
	1077	Küpeşte Profili	1,587 kg/m	...	...	



★ Yandaki profil birim ağırlıkları, bilgisayarda hesaplanmış teorik ağırlıklardır.

PROFİL KESİTİ	PROFİL KODU	PROFİL ADI	AĞIRLIK	ATALET MOMENTLERİ		SAYFA NO
				$J_x$ (cm <sup>4</sup> )	$J_y$ (cm <sup>4</sup> )	
	1379	Küpeşte Profili	4,039 kg/m	...	...	
	1073	Küpeşte Profili	5,389 kg/m	...	...	
	1917	Küpeşte Profili	3,910 kg/m	...	...	
	1817	Küpeşte Profili	2,430 kg/m	...	...	
	1009	Küpeşte Profili	3,070 kg/m	...	...	
	1075	Küpeşte Profili	3,628 kg/m	...	...	
	1098	Küpeşte Profili	4,144 kg/m	...	...	
	1219	Küpeşte Profili	2,675 kg/m	...	...	
	1178	Küpeşte Profili	2,750 kg/m	...	...	
	1008	Küpeşte Profili	2,773 kg/m	...	...	
	1374	Küpeşte Profili	1,653 kg/m	...	...	
	1319	Küpeşte Profili	1,295 kg/m	...	...	
	1164	Küpeşte Profili	2,460 kg/m	...	...	
	1183	Küpeşte Profili	4,530 kg/m	...	...	

★ Yandaki profil birim ağırlıkları, bilgisayarda hesaplanmış teorik ağırlıklardır.

PROFİL KESİTİ	PROFİL KODU	PROFİL ADI	AĞIRLIK	ATALET MOMENTLERİ		SAYFA NO
				$J_x$ (cm <sup>4</sup> )	$J_y$ (cm <sup>4</sup> )	
	2060	Küpeşte Profili	0,463 kg/m	...	...	
	2030	Küpeşte Profili	3,078 kg/m	...	...	
	1002	Küpeşte Profili	2,986 kg/m	...	...	
	1160	Küpeşte Profili	3,018 kg/m	...	...	
	1161	Küpeşte Profili	3,349 kg/m	...	...	
	1260	Küpeşte Profili	2,678 kg/m	...	...	
	1190	Küpeşte Profili	4,065 kg/m	...	...	
	1065	Küpeşte Profili	10,11 kg/m	...	...	
	1189	Küpeşte Profili	3,506 kg/m	...	...	
	1025	Küpeşte Profili	3,516 kg/m	...	...	
	1026	Küpeşte Profili	2,636 kg/m	...	...	
	1732	Küpeşte Profili	3,609 kg/m	...	...	
	1038	Küpeşte Profili	2,140 kg/m	...	...	
	1039	Küpeşte Profili	2,201 kg/m	...	...	

★ Yandaki profil birim ağırlıkları, bilgisayarda hesaplanmış teorik ağırlıklardır.

PROFİL KESİTİ	PROFİL KODU	PROFİL ADI	AĞIRLIK	ATALET MOMENTLERİ		SAYFA NO
				$J_x$ (cm <sup>4</sup> )	$J_y$ (cm <sup>4</sup> )	
	4047	Küpeşte Profili	1,533 kg/m	...	...	
	4360	Küpeşte Profili	0,450 kg/m	...	...	
				...	...	
				...	...	
				...	...	
				...	...	
				...	...	
				...	...	
				...	...	
				...	...	
				...	...	
				...	...	
				...	...	
				...	...	

★ Yandaki profil birim ağırlıkları, bilgisayarla hesaplanmış teorik ağırlıklardır.

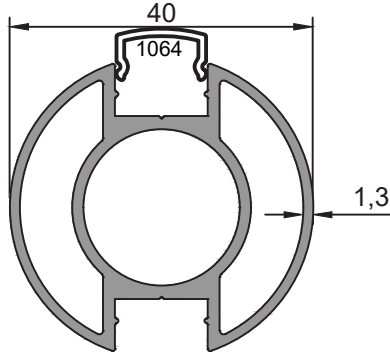

<b>1361</b>
Küpeşte Profili
0,815 kg/m

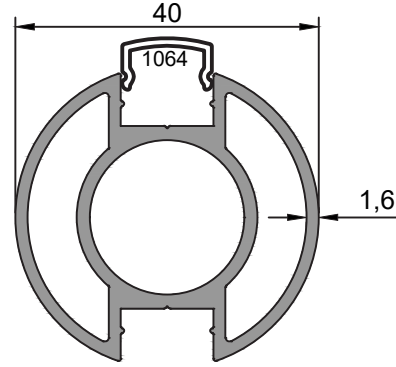

<b>1020</b>
Küpeşte Profili
0,912 kg/m

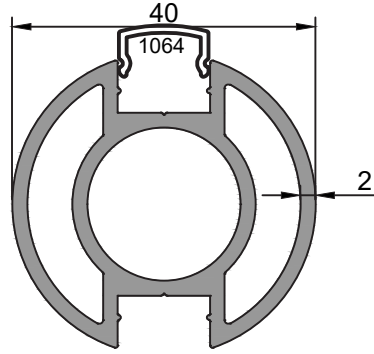

<b>1251</b>
Küpeşte Profili
1,064 kg/m

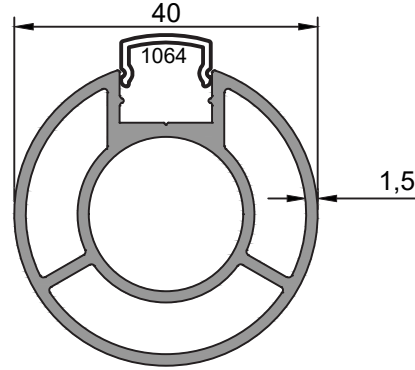

<b>1021</b>
Küpeşte Profili
0,870 kg/m



★ Yandaki profil birim ağırlıkları, bilgisayarda hesaplanmış teorik ağırlıklardır.

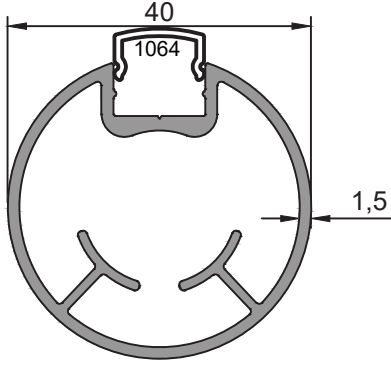

<b>2052</b>
Küpeşte Profili
0,700 kg/m

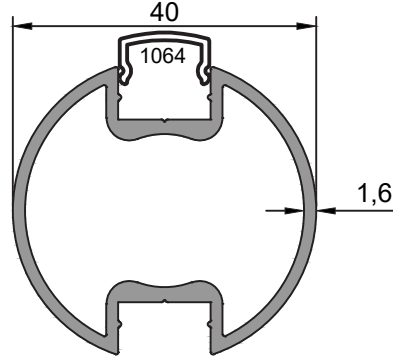

<b>1359</b>
Küpeşte Profili
0,688 kg/m

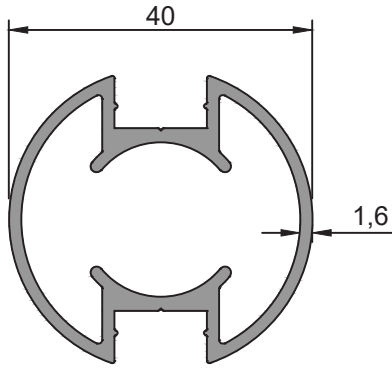

<b>1014</b>
Küpeşte Profili
0,780 kg/m

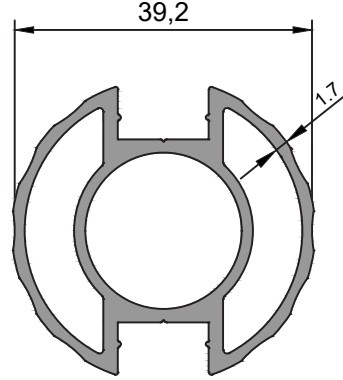

<b>1314</b>
Küpeşte Profili
0,893 kg/m

★ Yandaki profil birim ağırlıkları, bilgisayararda hesaplanmış teorik ağırlıklardır.

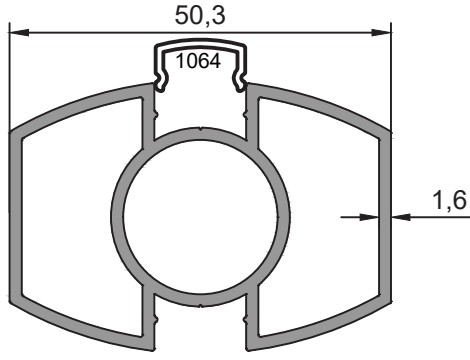

<b>1690</b>
Küpeşte Profili
0,935 kg/m

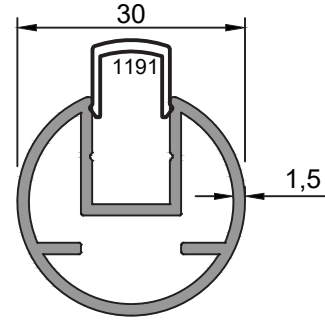

<b>1194</b>
Küpeşte Profili
0,519 kg/m

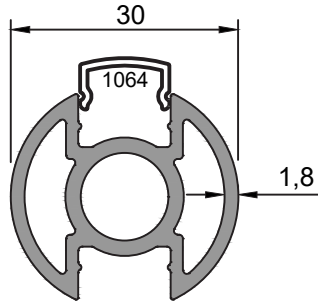

<b>1252</b>
Küpeşte Profili
0,672 kg/m

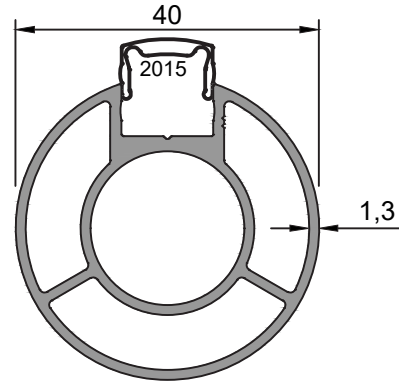

<b>2014</b>
Küpeşte Profili
0,781 kg/m

★ Yandaki profil birim ağırlıkları, bilgisayarda hesaplanmış teorik ağırlıklardır.

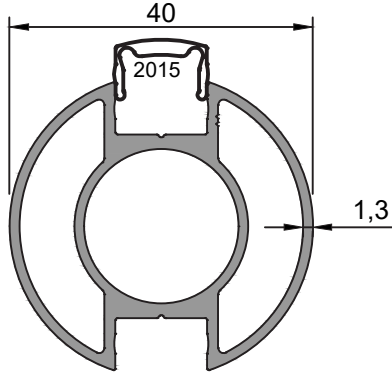

<b>2095</b>
Küpeşte Profili
0,780 kg/m

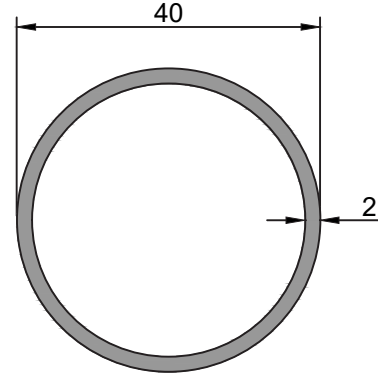

<b>1169</b>
Küpeşte Profili
0,647 kg/m

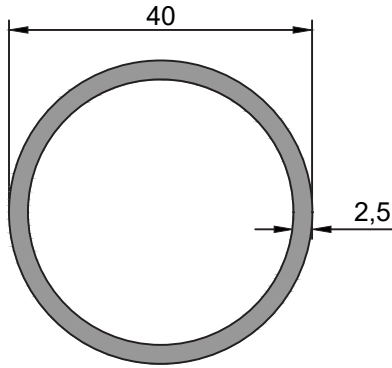

<b>1926</b>
Küpeşte Profili
0,798 kg/m

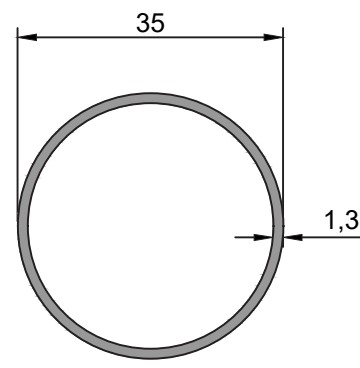

<b>2640</b>
Küpeşte Profili
0,373 kg/m

★ Yandaki profil birim ağırlıkları, bilgisayarla hesaplanmış teorik ağırlıklardır.

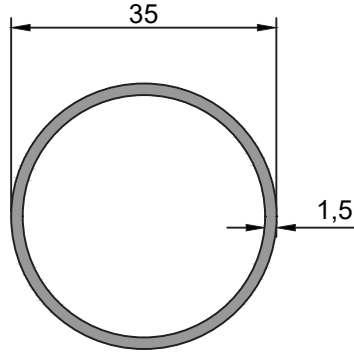

<b>2641</b>
Küpeşte Profili
0,428 kg/m

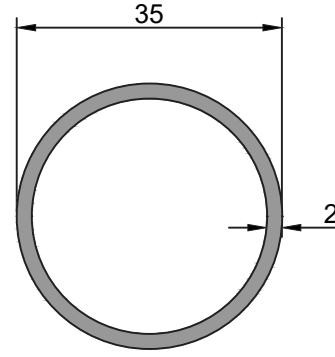

<b>2736</b>
Küpeşte Profili
0,562 kg/m

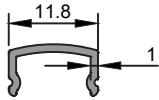

<b>1064</b>
0,060 kg/m

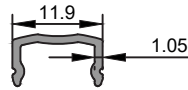

<b>1315</b>
0,064 kg/m

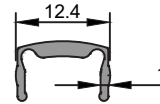

<b>2015</b>
0,079 kg/m

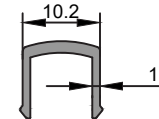

<b>1191</b>
0,085 kg/m

★ Yandaki profil birim ağırlıkları, bilgisayarda hesaplanmış teorik ağırlıklardır.

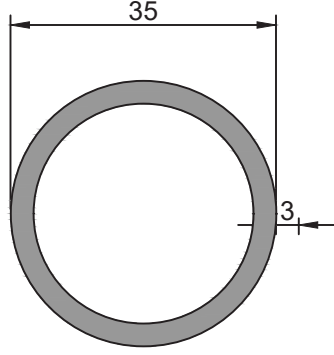

<b>2194</b>
Küpeşte Profili
0,817 kg/m

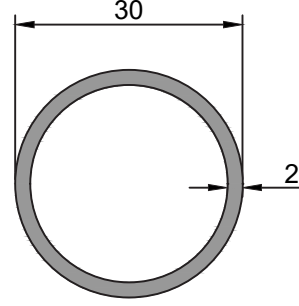

<b>1173</b>
Küpeşte Profili
0,477 kg/m

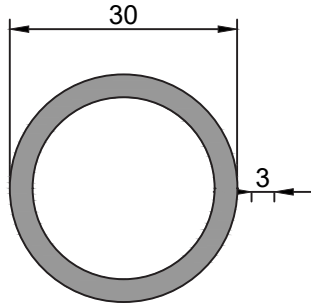

<b>1048</b>
Küpeşte Profili
0,690 kg/m

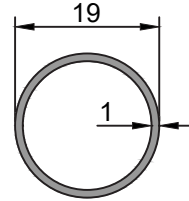

<b>2639</b>
Küpeşte Profili
0,153 kg/m

★ Yandaki profil birim ağırlıkları, bilgisayarla hesaplanmış teorik ağırlıklardır.

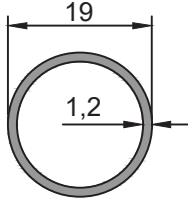

<b>2519</b>
Küpeşte Profili
0,182 kg/m

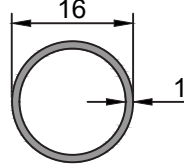

<b>1804</b>
Küpeşte Profili
0,128 kg/m

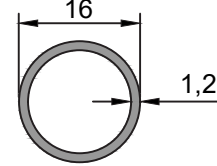

<b>1606</b>
Küpeşte Profili
0,151 kg/m

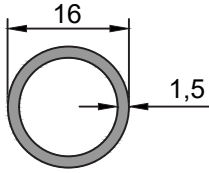

<b>1063</b>
Küpeşte Profili
0,185 kg/m

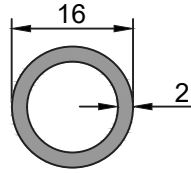

<b>1011</b>
Küpeşte Profili
0,238 kg/m

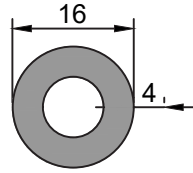

<b>1308</b>
Küpeşte Profili
0,409 kg/m

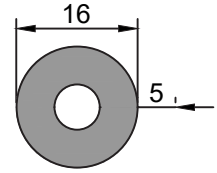

<b>1172</b>
Küpeşte Profili
0,468 kg/m

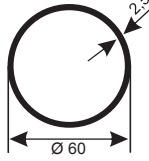
**HA - 3001**

Ø 60 Boru  
 Ø 60 Tube  
 1219 gr/mt

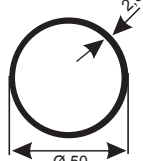
**HA - 3002**

Ø 50 Boru  
 Ø 50 Tube  
 1007 gr/mt

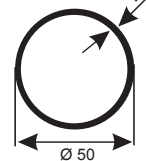
**HA - 3002A**

Ø 50 Boru  
 Ø 50 Tube  
 814 gr/mt

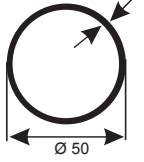
**HA - 3002B**

Ø 50 Boru  
 Ø 50 Tube  
 619 gr/mt

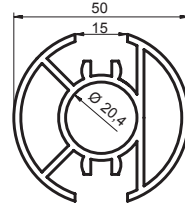
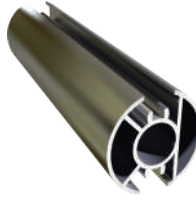
**HA - 3002C**

Ø 50 Dikme 2 Kanallı  
 Ø 50 Struts 2 Canals  
 1730 gr/mt

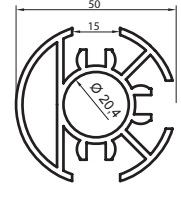
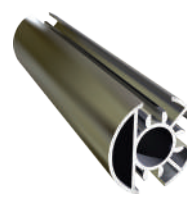
**HA - 3002D**

Ø 50 Dikme 3 Kanallı  
 Ø 50 Struts 3 Canals  
 1690 gr/mt

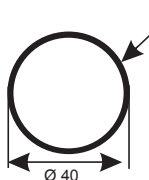
**HA - 3003**

Ø 40 Boru  
 Ø 40 Pipe  
 795 gr/mt

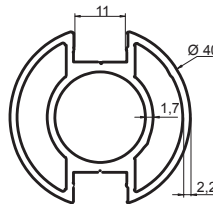

**HA - 3004**

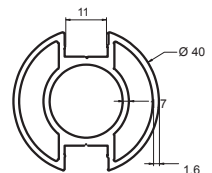
Ø 40 Dikme  
 Ø 40 Struts 2 Canals  
 1100 gr/mt

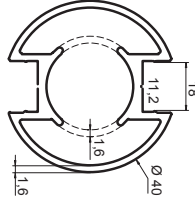

**HA - 3004A**

Ø 40 Dikme  
 Ø 40 Struts 2 Canals  
 918 gr/mt

★ Yandaki profil birim ağırlıkları, bilgisayarda hesaplanmış teorik ağırlıklardır.

**HA - 3004B**

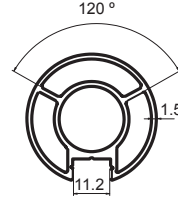
Ø 40 Boş Dikme  
 Ø 40 Hollow Struts 2  
 Canals  
 785 gr/mt

**HA - 3004C**

Ø 40 Dikme Tek Kanallı  
 Ø 40 Struts Single Canal  
 877 gr/mt

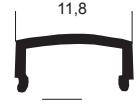
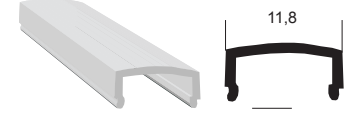
**HA - 3005**

Dikme Kanal Kapağı  
 Struts Canal Cover  
 60 gr/mt

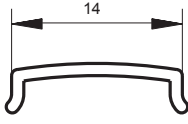
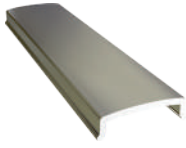
**HA - 3005A**

Ø 30 Dikme Kanal Kapağı  
 Ø 30 Struts Canal Cover  
 55 gr/mt

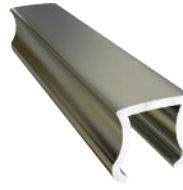
**HA - 3005B**

Ø 50 Dikme Kanal Kapağı  
 Ø 50 Struts Canal Cover  
 135 gr/mt

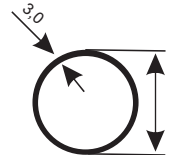
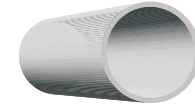
**HA - 3006**

Ø 30 Boru  
 Ø 30 Pipe  
 687 gr/mt

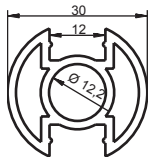
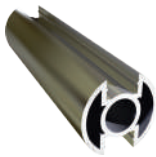
**HA - 3006A**

Ø 30 Dikme  
 Ø 30 Struts  
 2 Canals 680 gr/mt

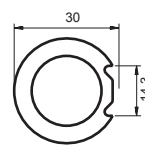
**HA - 3006B**

Ø 30 Dikme  
 Tek Kanallı  
 Ø 30 Struts Single Canal 975 gr/mt

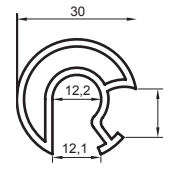
**HA - 3006C**

Ø 30 Dikme 90°  
 Ø 30 Struts 2 Canals  
 90°  
 620 gr/mt

★ Yandaki profil birim ağırlıkları, bilgisayarda hesaplanmış teorik ağırlıklardır.



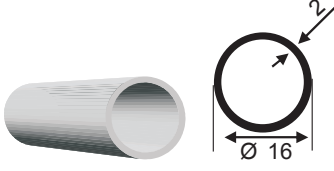

**HA - 3007**

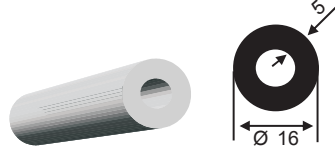
Ø 16 Boru  
 Ø 16 Pipe  
 230 gr/mt

**HA - 3007A**

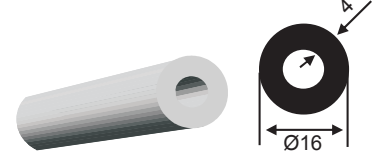
Ø 16 Boru  
 Ø 16 Pipe  
 470 gr/mt

**HA - 3007B**

Ø 16 Boru  
 Ø 16 Pipe  
 410 gr/mt

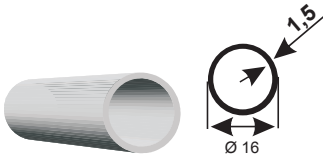
**HA - 3007C**

Ø 16 Boru  
 Ø 16 Pipe  
 182 gr/mt

**HA - 3001A**

Ø 12 Kare Profil  
 Ø 12 Square Pipe  
 206 gr/mt  
 Özel İmalat

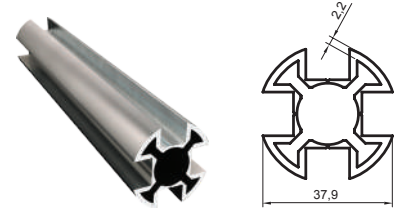
**HA - 3004D**

Ø 40 Dikme 4 Kanallı  
 Ø 40 Struts 4 Canals  
 999 gr/mt

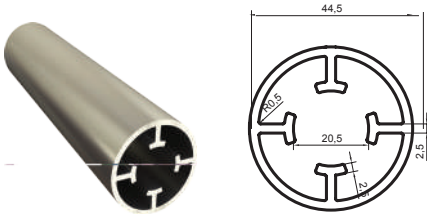
**HA - 3004E**

Ø 40 Kanalsız Dikme  
 Ø 40 Struts No Canal  
 1301 gr/mt

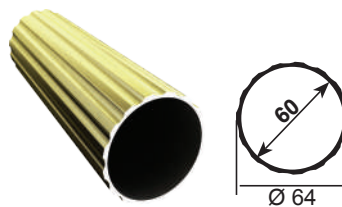
**HA - 3036**

Ø 60 Büyük Dekorlu Tapa Dikmesi  
 Ø 60 Decorative Pipe  
 1500 gr/mt

★ Yandaki profil birim ağırlıkları, bilgisayarda hesaplanmış teorik ağırlıklardır.

★ Yandaki profil birim ağırlıkları, bilgisayarla hesaplanmış teorik ağırlıklardır.

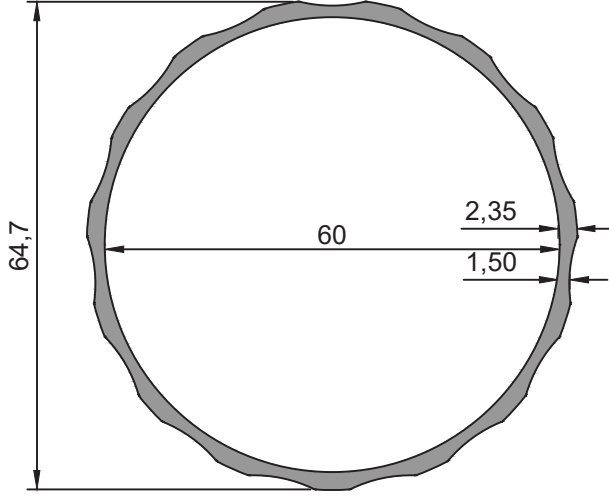

<b>1605</b>
Küpeşte Profili
1,043 kg/m

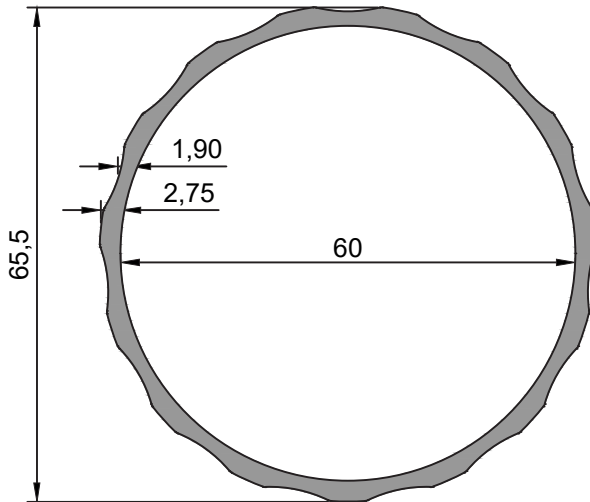

<b>1317</b>
Küpeşte Profili
1,266 kg/m

★ Yandaki profil birim ağırlıkları, bilgisayarda hesaplanmış teorik ağırlıklardır.

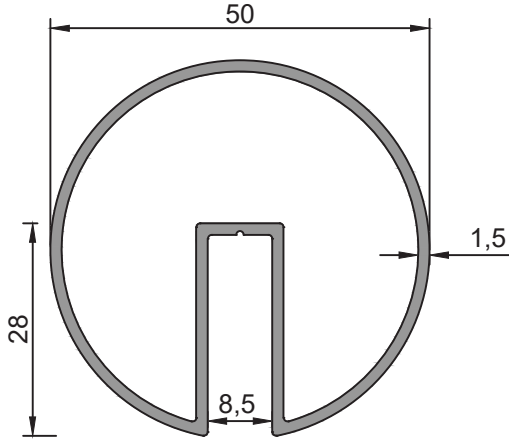

<b>2055</b>
Küpeşte Profili
0,834 kg/m

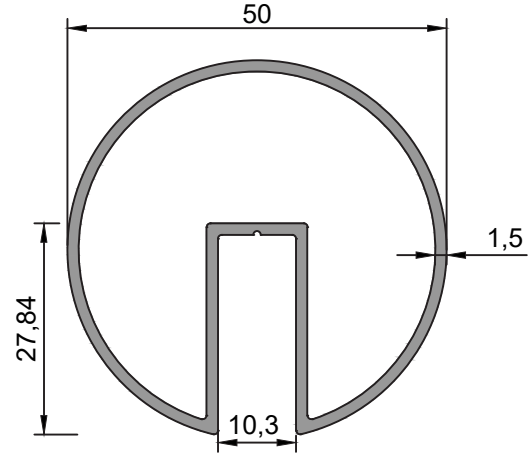

<b>2054</b>
Küpeşte Profili
0,832 kg/m

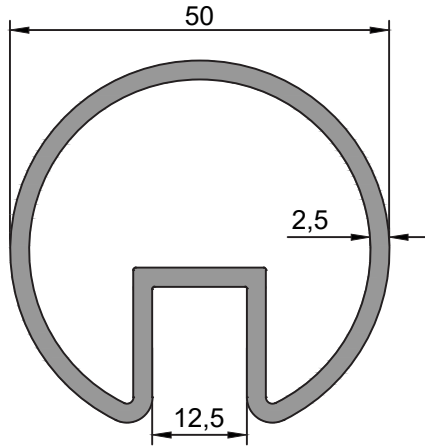

<b>1986</b>
Küpeşte Profili
1,238 kg/m

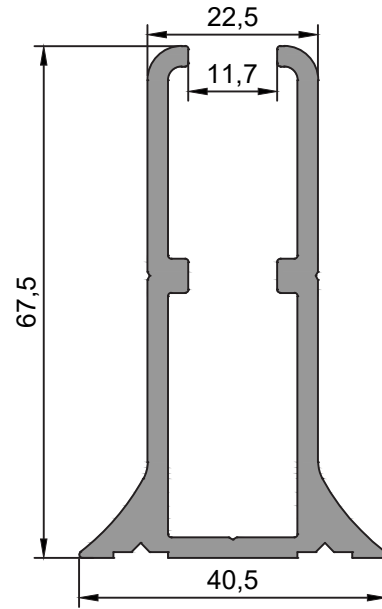

<b>1985</b>
Küpeşte Profili
1,414 kg/m

★ Yandaki profil birim ağırlıkları, bilgisayarla hesaplanmış teorik ağırlıklardır.

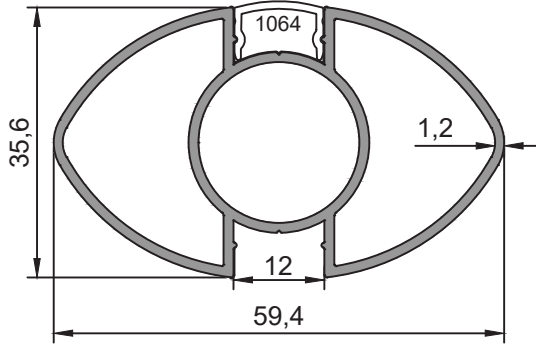

<b>2070</b>
Küpeşte Profili
0,770 kg/m

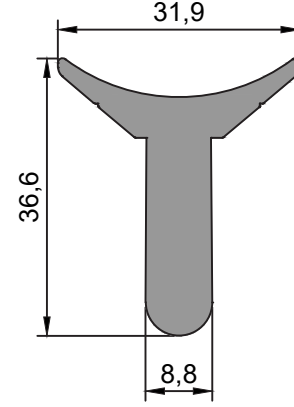

<b>1005</b>
Küpeşte Profili
0,973 kg/m

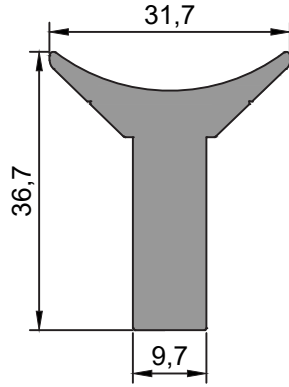

<b>1162</b>
Küpeşte Profili
1,092 kg/m

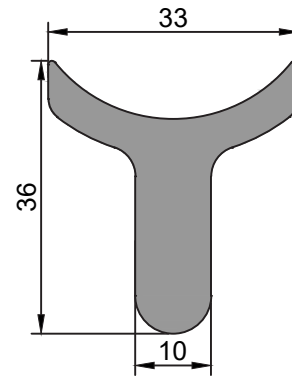

<b>1244</b>
Küpeşte Profili
1,116 kg/m

★ Yandaki profil birim ağırlıkları, bilgisayarla hesaplanmış teorik ağırlıklardır.

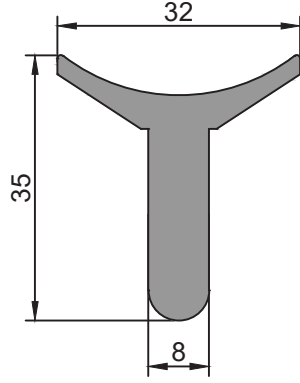

<b>1819</b>
Küpeşte Profili
0,854 kg/m

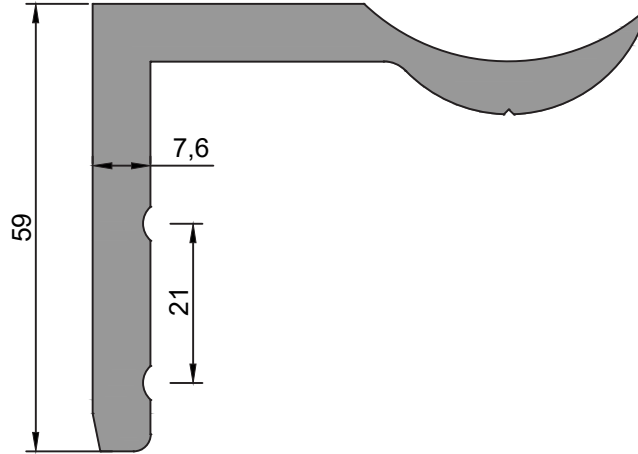

<b>1027</b>
Küpeşte Profili
2,365 kg/m

★ Yandaki profil birim ağırlıkları, bilgisayarla hesaplanmış teorik ağırlıklardır.

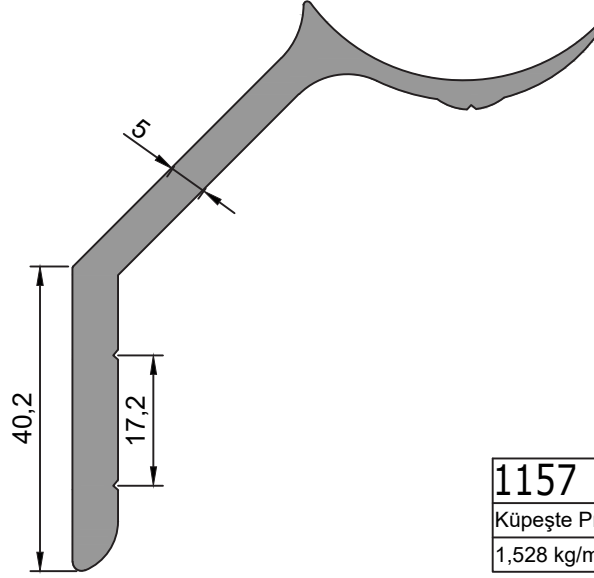

<b>1157</b>
Küpeşte Profili
1,528 kg/m

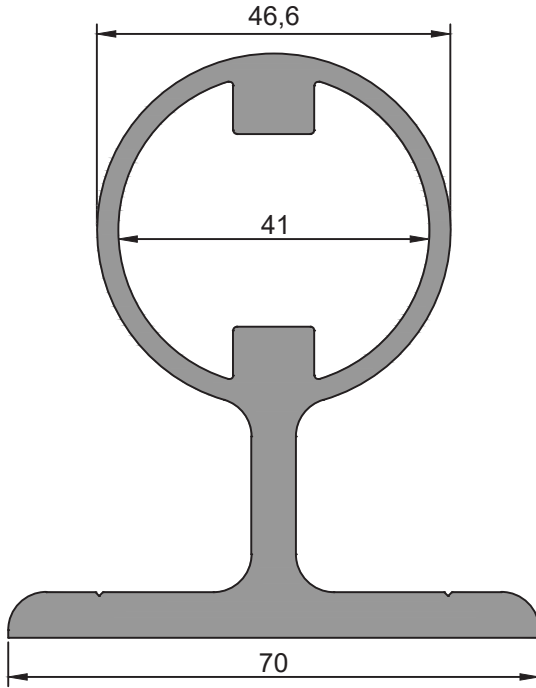

<b>1286</b>
Küpeşte Profili
3,027 kg/m

★ Yandaki profil birim ağırlıkları, bilgisayarda hesaplanmış teorik ağırlıklardır.

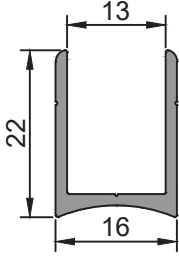

<b>1275</b>
Küpeşte Profili
0,240 kg/m

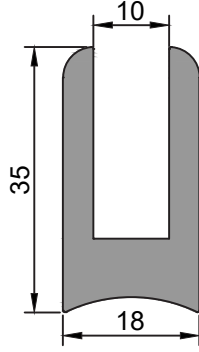

<b>1646</b>
Küpeşte Profili
0,942 kg/m

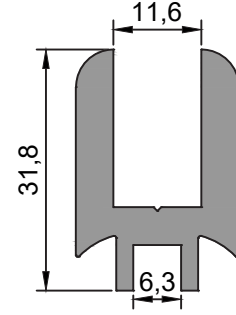

<b>1007</b>
Küpeşte Profili
0,892 kg/m

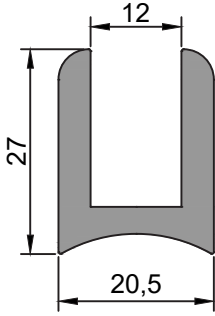

<b>1045</b>
Küpeşte Profili
0,709 kg/m

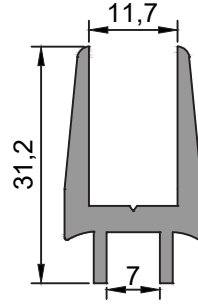

<b>1820</b>
Küpeşte Profili
0,511 kg/m

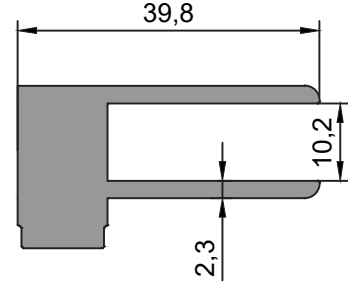

<b>1023</b>
Küpeşte Profili
1,023 kg/m

★ Yandaki profil birim ağırlıkları, bilgisayarla hesaplanmış teorik ağırlıklardır.

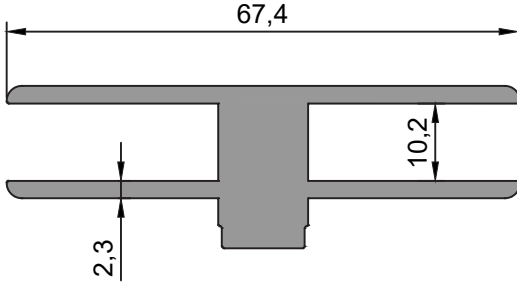

<b>1024</b>
Küpeşte Profili
1,367 kg/m

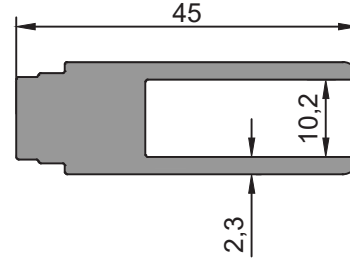

<b>1177</b>
Küpeşte Profili
0,968 kg/m

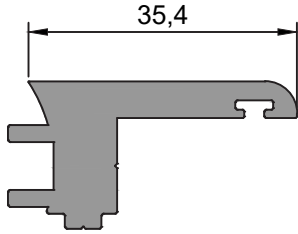

<b>1070</b>
Küpeşte Profili
0,803 kg/m

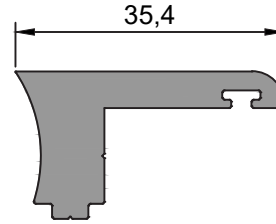

<b>1072</b>
Küpeşte Profili
0,737 kg/m



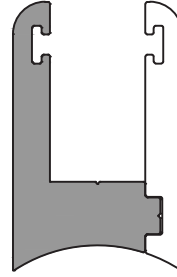
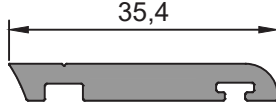

<b>1071</b>
Küpeşte Profili
0,383 kg/m

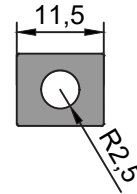
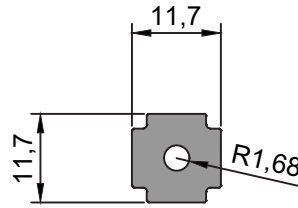
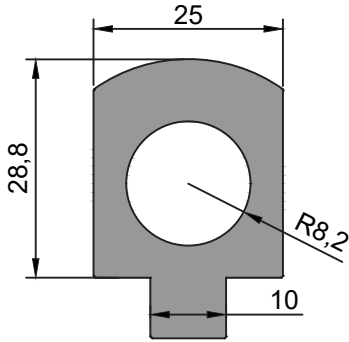

<b>1003</b>
Küpeşte Profili
1,508 kg/m

<b>1615</b>
Küpeşte Profili
0,306 kg/m

<b>1163</b>
Küpeşte Profili
0,243 kg/m

★ Yandaki profil birim ağırlıkları, bilgisayarda hesaplanmış teorik ağırlıklardır.

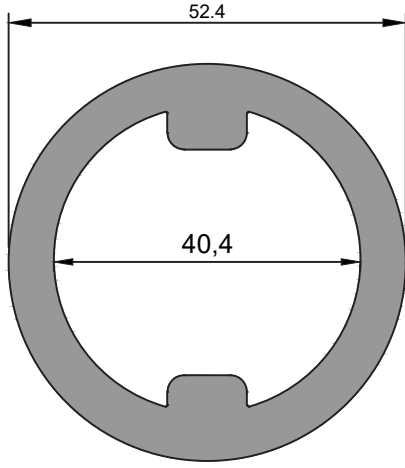

<b>1013</b>
Küpeşte Profili
2,649 kg/m

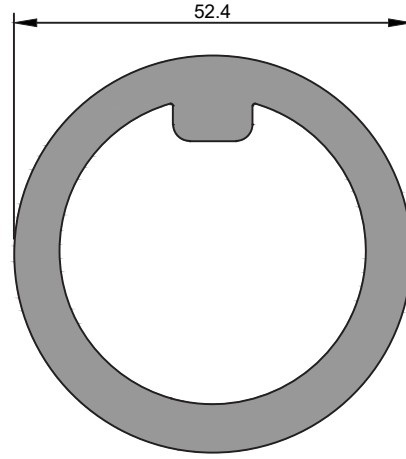

<b>1028</b>
Küpeşte Profili
2,524 kg/m

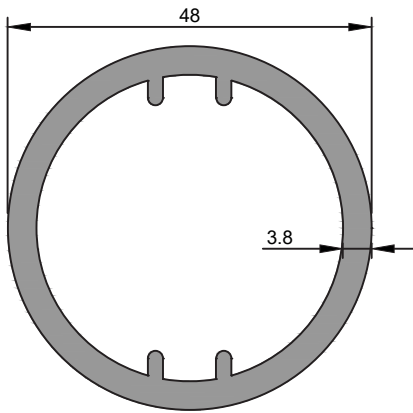

<b>1818</b>
Küpeşte Profili
1,502 kg/m

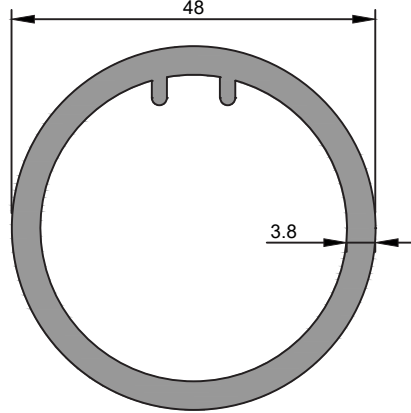

<b>1930</b>
Küpeşte Profili
1,465 kg/m

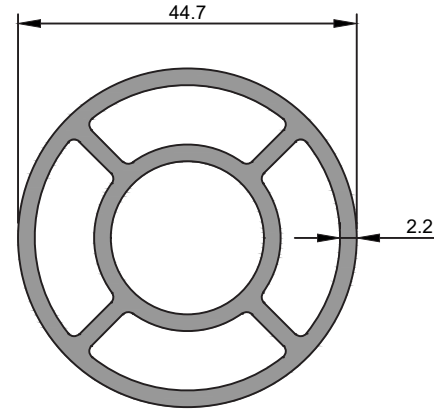

<b>1174</b>
Küpeşte Profili
1,412 kg/m

★ Yandaki profil birim ağırlıkları, bilgisayarda hesaplanmış teorik ağırlıklardır.

★ Yandaki profil birim ağırlıkları, bilgisayarda hesaplanmış teorik ağırlıklardır.

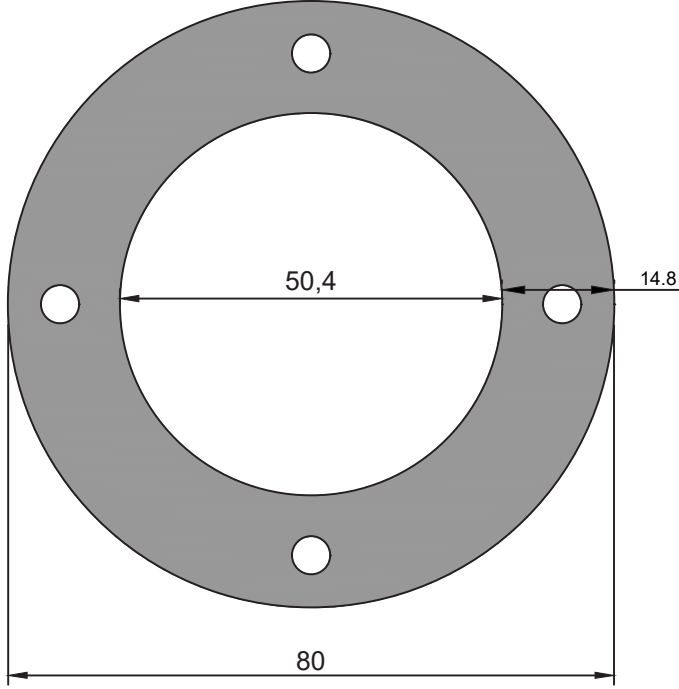

<b>1000</b>
Küpeşte Profili
8,003 kg/m

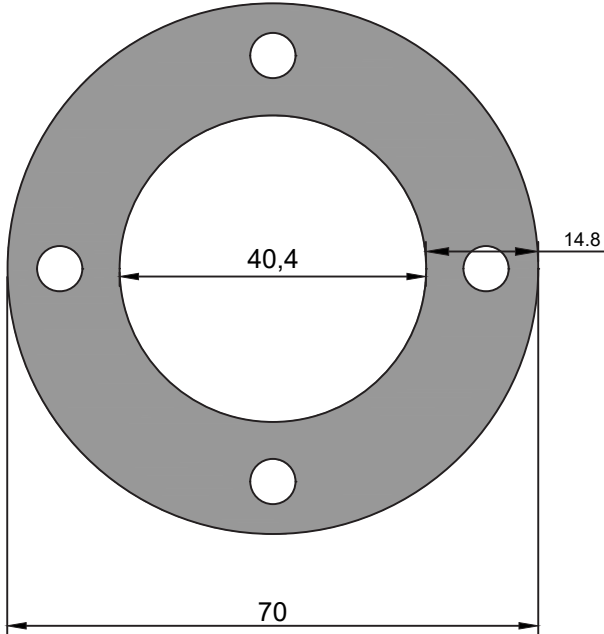

<b>1001</b>
Küpeşte Profili
6,648 kg/m

★ Yandaki profil birim ağırlıkları, bilgisayarda hesaplanmış teorik ağırlıklardır.

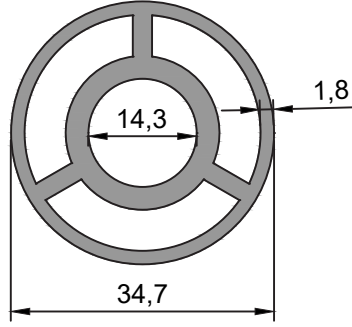

<b>1647</b>
Küpeşte Profili
1,055 kg/m

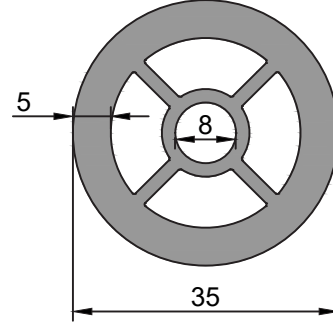

<b>1077</b>
Küpeşte Profili
1,587 kg/m

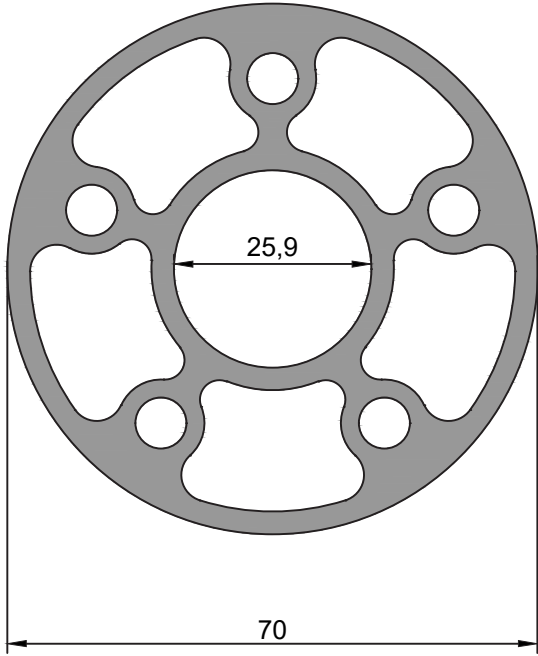

<b>1379</b>
Küpeşte Profili
4,039 kg/m

★ Yandaki profil birim ağırlıkları, bilgisayarla hesaplanmış teorik ağırlıklardır.

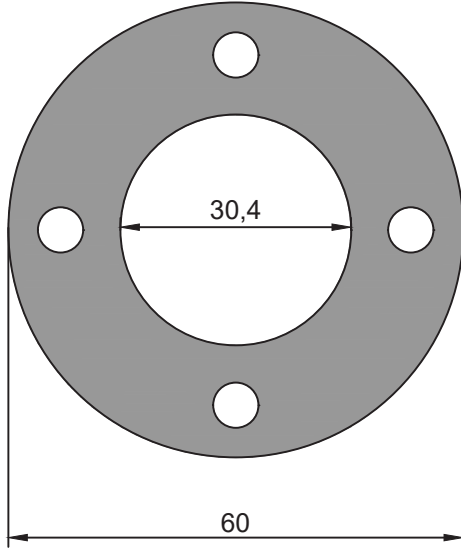

<b>1073</b>
Küpeşte Profili
5,389 kg/m

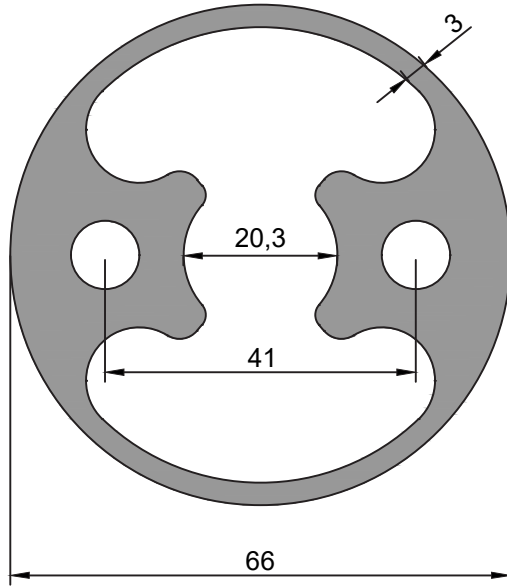

<b>1917</b>
Küpeşte Profili
3,910 kg/m

★ Yandaki profil birim ağırlıkları, bilgisayarla hesaplanmış teorik ağırlıklardır.

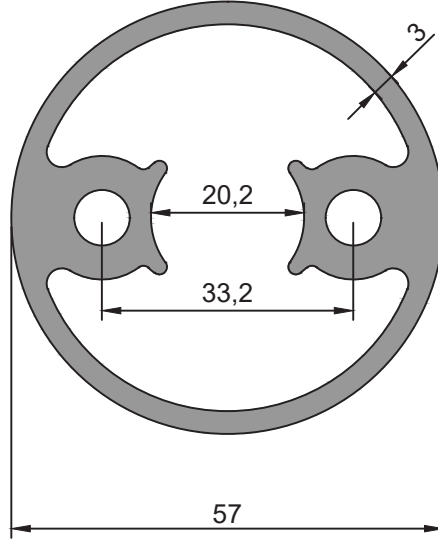

<b>1817</b>
Küpeşte Profili
2,430 kg/m

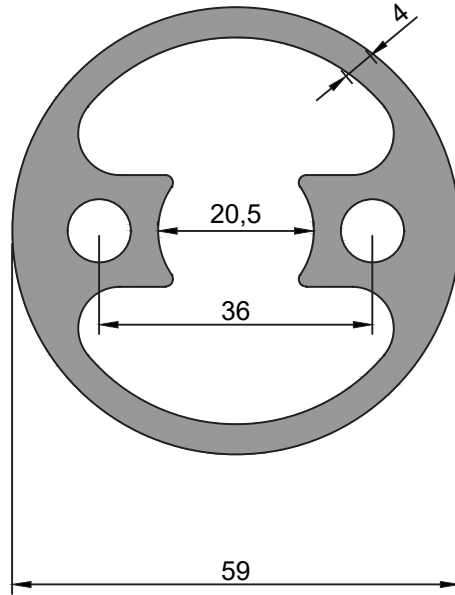

<b>1009</b>
Küpeşte Profili
3,070 kg/m

★ Yandaki profil birim ağırlıkları, bilgisayarda hesaplanmış teorik ağırlıklardır.

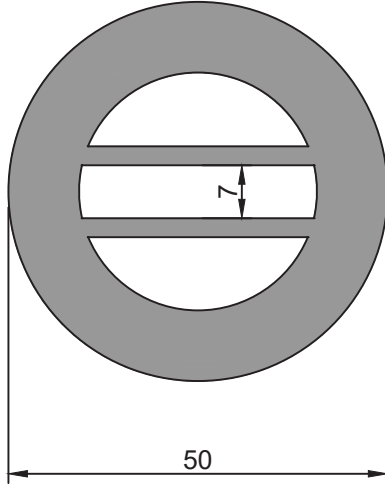

<b>1075</b>
Küpeşte Profili
3,628 kg/m

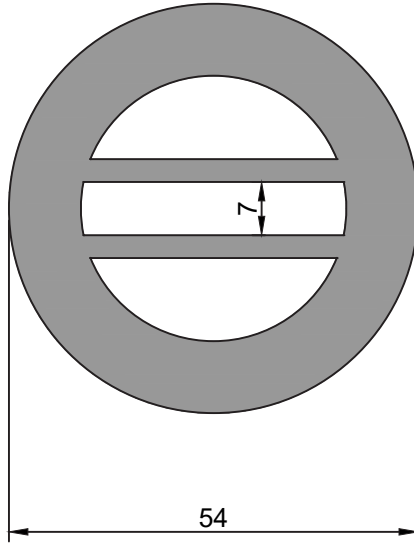

<b>1098</b>
Küpeşte Profili
4,144 kg/m

★ Yandaki profil birim ağırlıkları, bilgisayarla hesaplanmış teorik ağırlıklardır.

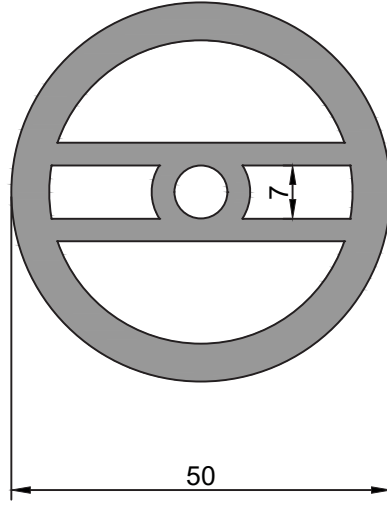

<b>1219</b>
Küpeşte Profili
2,675 kg/m

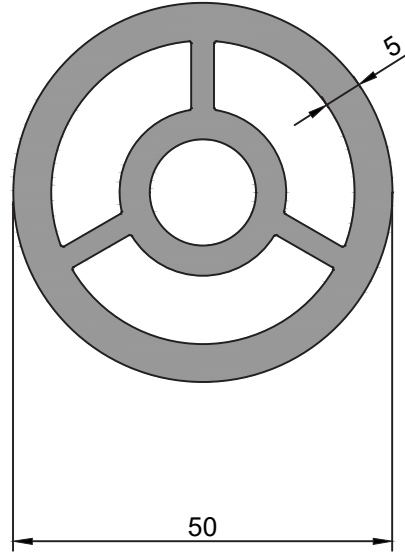

<b>1178</b>
Küpeşte Profili
2,750 kg/m



★ Yandaki profil birim ağırlıkları, bilgisayarda hesaplanmış teorik ağırlıklardır.

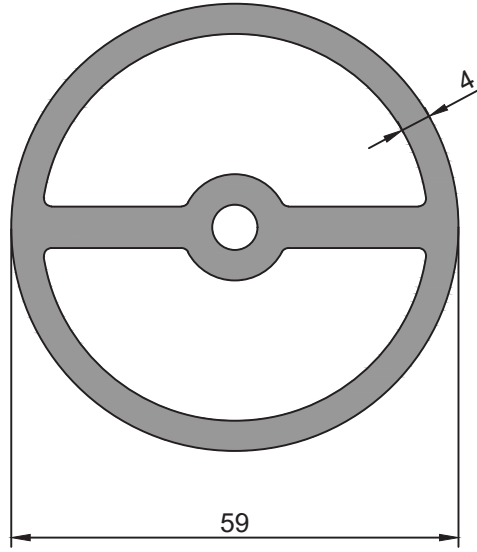

<b>1008</b>
Küpeşte Profili
2,773 kg/m

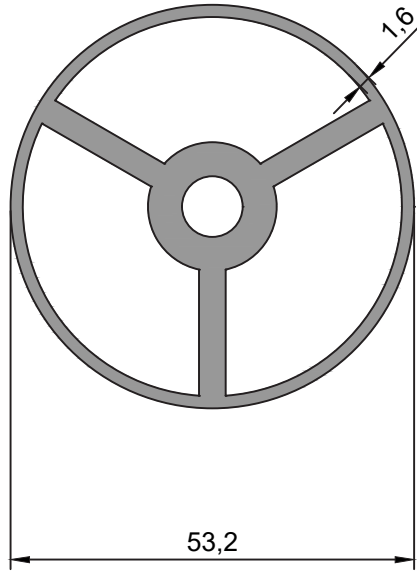

<b>1374</b>
Küpeşte Profili
1,653 kg/m

★ Yandaki profil birim ağırlıkları, bilgisayarla hesaplanmış teorik ağırlıklardır.

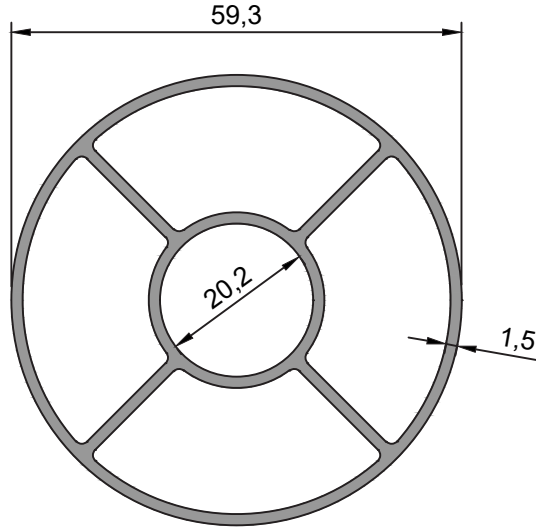

<b>1319</b>
Küpeşte Profili
1,295 kg/m

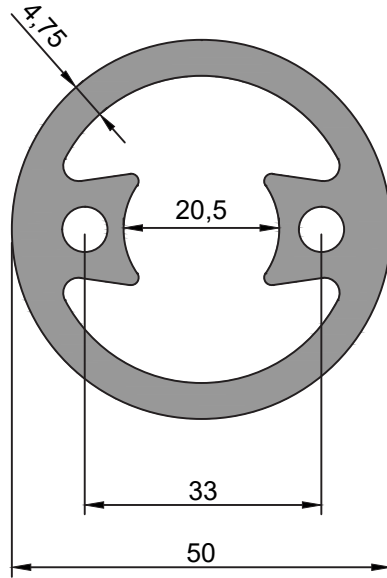

<b>1164</b>
Küpeşte Profili
2,460 kg/m

★ Yandaki profil birim ağırlıkları, bilgisayarda hesaplanmış teorik ağırlıklardır.

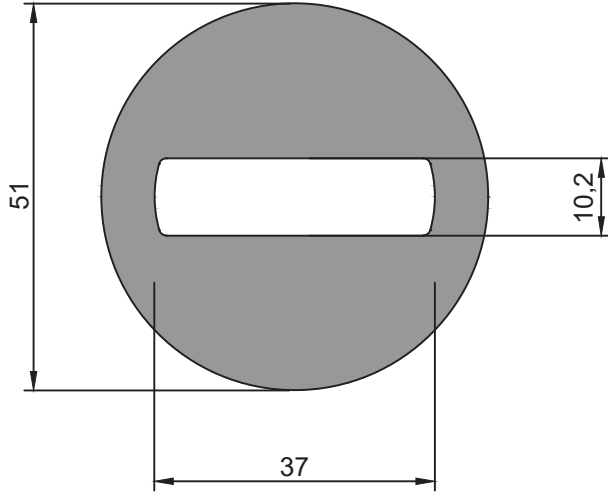

<b>1183</b>
Küpeşte Profili
4,530 kg/m

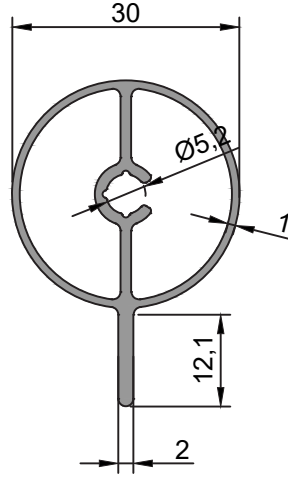

<b>2060</b>
Küpeşte Profili
0,463 kg/m

★ Yandaki profil birim ağırlıkları, bilgisayarla hesaplanmış teorik ağırlıklardır.

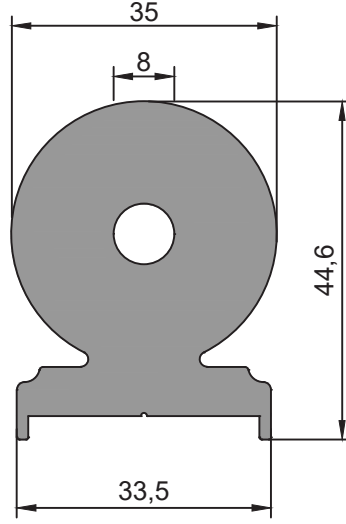

<b>2030</b>
Küpeşte Profili
3,078 kg/m

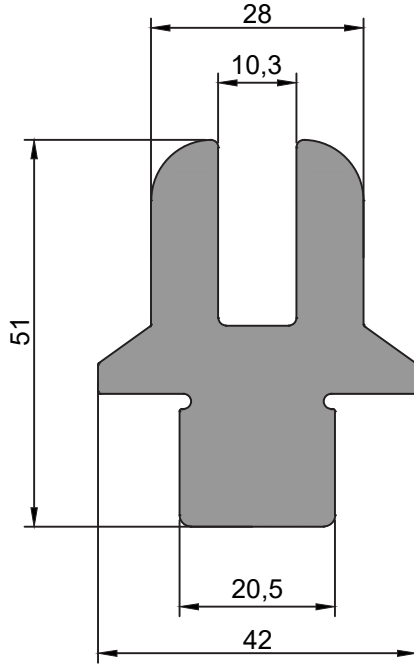

<b>1002</b>
Küpeşte Profili
2,986 kg/m

★ Yandaki profil birim ağırlıkları, bilgisayarla hesaplanmış teorik ağırlıklardır.

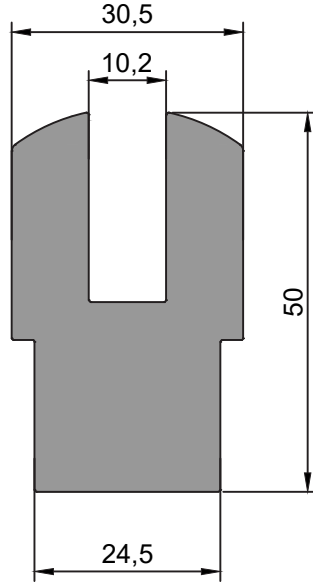

<b>1160</b>
Küpeşte Profili
3,018 kg/m

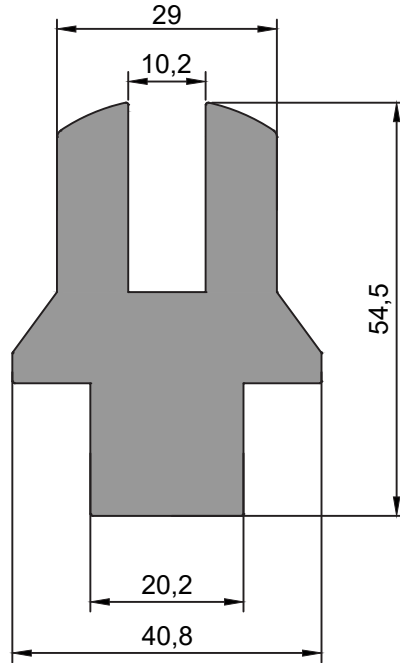

<b>1161</b>
Küpeşte Profili
3,349 kg/m

★ Yandaki profil birim ağırlıkları, bilgisayarda hesaplanmış teorik ağırlıklardır.

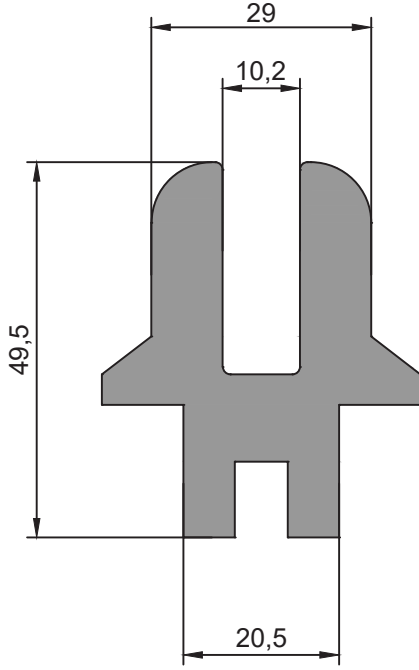

<b>1260</b>
Küpeşte Profili
2,678 kg/m

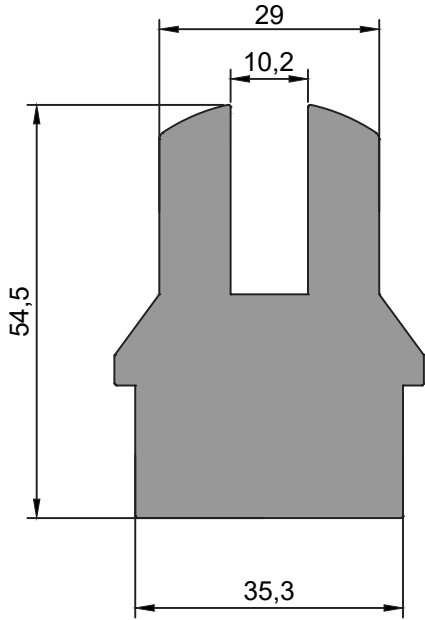

<b>1190</b>
Küpeşte Profili
4,065 kg/m

★ Yandaki profil birim ağırlıkları, bilgisayarda hesaplanmış teorik ağırlıklardır.

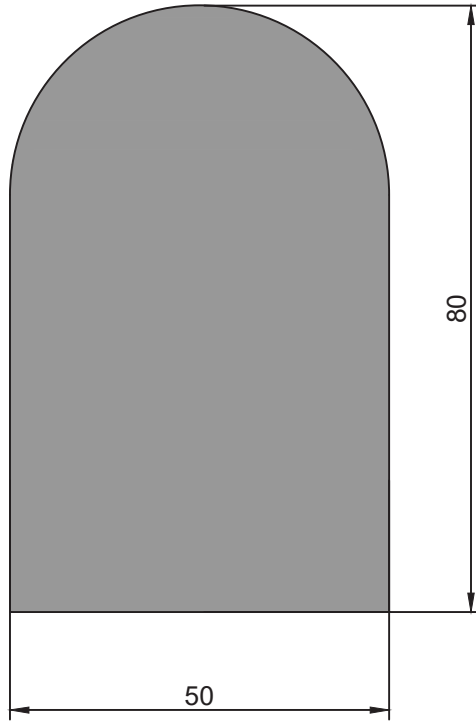

1065
Küpeşte Profili
10,11 kg/m

★ Yandaki profil birim ağırlıkları, bilgisayarda hesaplanmış teorik ağırlıklardır.

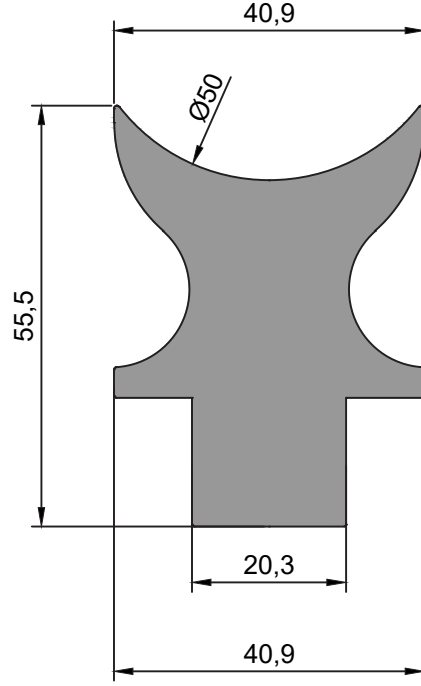

<b>1189</b>
Küpeşte Profili
3,506 kg/m

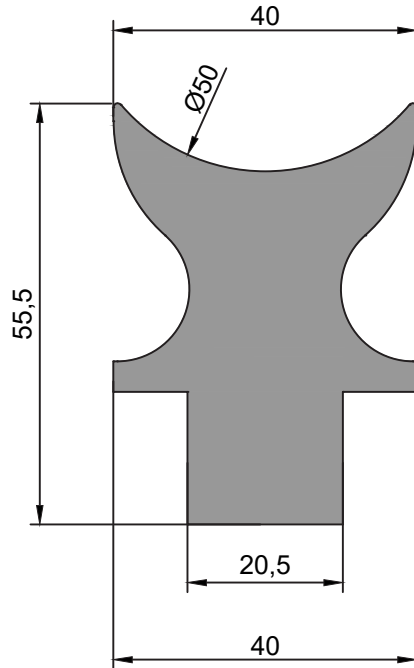

<b>1025</b>
Küpeşte Profili
3,516 kg/m



★ Yandaki profil birim ağırlıkları, bilgisayarda hesaplanmış teorik ağırlıklardır.

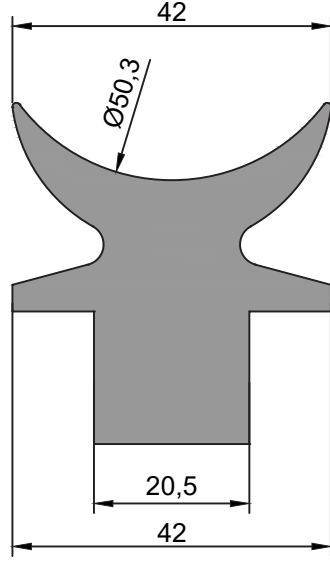

<b>1026</b>
Küpeşte Profili
2,636 kg/m

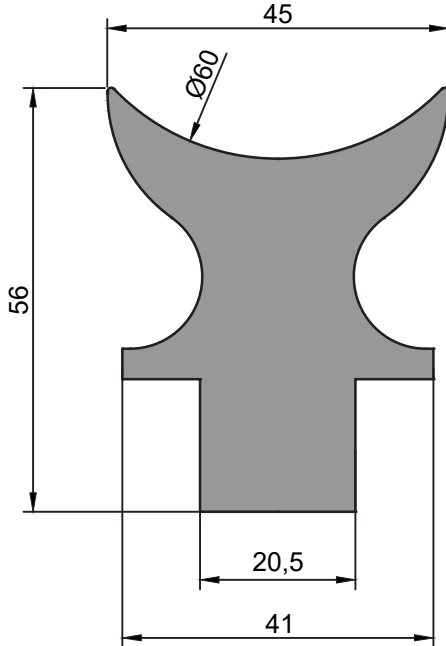

<b>1732</b>
Küpeşte Profili
3,609 kg/m

★ Yandaki profil birim ağırlıkları, bilgisayarla hesaplanmış teorik ağırlıklardır.

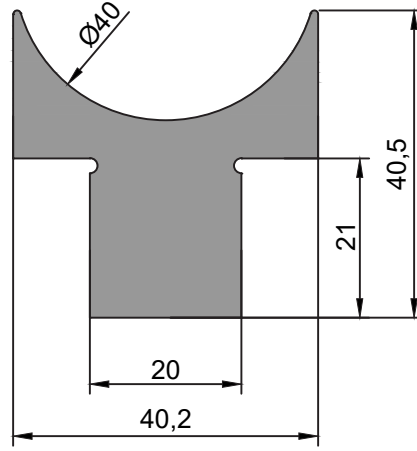
**1038**

Küpeşte Profili

2,140 kg/m

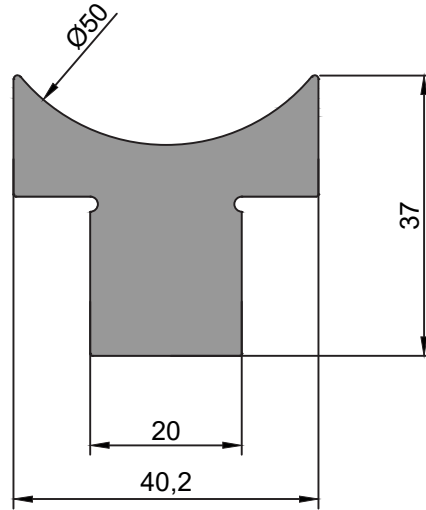
**1039**

Küpeşte Profili

2,201 kg/m



## PROFİL KATALOĐU















# KARE KÜPEŐTE PROFİLLERİ

## SQUARE PROFILES









★ Profil Ađırlıkları Teorik Olup Teslim Anındaki Ađırlık Geçerlidir

★ *Weight of profiles are theoretical, net weight will valid at the time of delivery.*

★ Yandaki profil birim ağırlıkları, bilgisayarda hesaplanmış teorik ağırlıklardır.

PROFİL KESİTİ	PROFİL KODU	PROFİL ADI	AĞIRLIK	ATALET MOMENTLERİ		SAYFA NO
				$J_x$ (cm <sup>4</sup> )	$J_y$ (cm <sup>4</sup> )	
	2877	80'lik Üst Profil	1,300 kg/m	...	...	
	2808	60'lık Üst Profil	0,856 kg/m	...	...	
	2878	Alt Profil	0,485 kg/m	...	...	
	2879	40'lık Dikme Profili	1,165 kg/m	...	...	
	2893	Dikme Kapak	0,055 kg/m	...	...	
	2880	Alt Profil Kapak	0,058 kg/m	...	...	
	3531	14'lük Emniyet Çubuğu	0,260 kg/m	...	...	
	4040	Küpeşte Profili	0,921 kg/m	...	...	
	4041	Küpeşte Profili	1,951 kg/m	...	...	
	4042	Küpeşte Profili	2,196 kg/m	...	...	
	4043	Küpeşte Profili	1,680 kg/m	...	...	
	4044	Küpeşte Profili	0,058 kg/m	...	...	
	4045	Küpeşte Profili	0,586 kg/m	...	...	
	4046	Küpeşte Profili	4,427 kg/m	...	...	

★ Yandaki profil birim ağırlıkları, bilgisayarda hesaplanmış teorik ağırlıklardır.

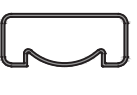
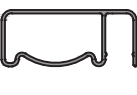
PROFİL KESİTİ	PROFİL KODU	PROFİL ADI	AĞIRLIK	ATALET MOMENTLERİ		SAYFA NO
				$J_x$ (cm <sup>4</sup> )	$J_y$ (cm <sup>4</sup> )	
	4361	Küpeşte Profili	0,077 kg/m	...	...	
	4362	Küpeşte Profili	0,363 kg/m	...	...	
	4363	Küpeşte Profili	0,087 kg/m	...	...	
	4364	Küpeşte Profili	0,114 kg/m	...	...	
	4365	Küpeşte Profili	0,179 kg/m	...	...	
	4366	Küpeşte Profili	0,683 kg/m	...	...	
	4367	Küpeşte Profili	0,081 kg/m	...	...	
	4368	Küpeşte Profili	0,824 kg/m	...	...	
	4369	Küpeşte Profili	0,076 kg/m	...	...	
	4370	Küpeşte Profili	0,704 kg/m	...	...	
	4371	Küpeşte Profili	0,718 kg/m	...	...	
				...	...	
				...	...	
				...	...	

★ Yandaki profil birim ağırlıkları, bilgisayarla hesaplanmış teorik ağırlıklardır.

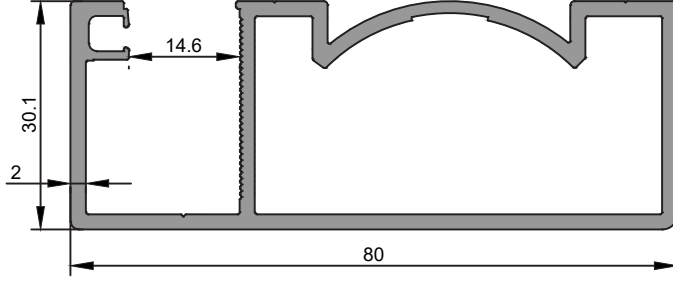
**2877**

80'lik Üst Profil

1,300 kg/m

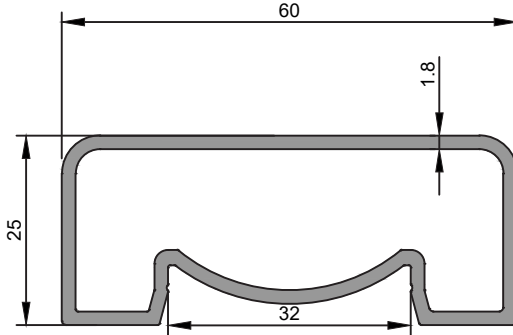
**2808**

60'lik Üst Profil

0,856 kg/m

★ Yandaki profil birim ağırlıkları, bilgisayarda hesaplanmış teorik ağırlıklardır.

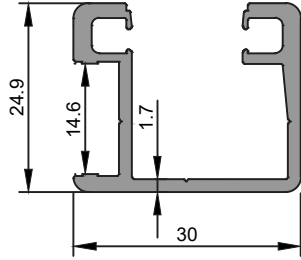

<b>2878</b>
Alt Profil
0,485 kg/m

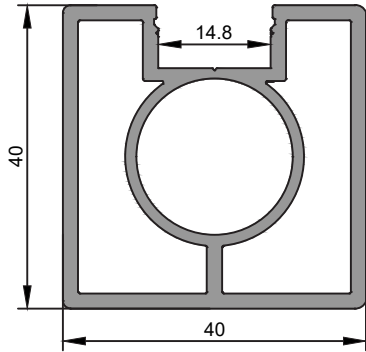

<b>2879</b>
40'lık Dikme Profili
1,165 kg/m

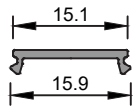

<b>2893</b>
Dikme Kapak
0,055 kg/m

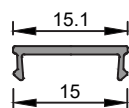

<b>2880</b>
Alt Profil Kapak
0,058 kg/m

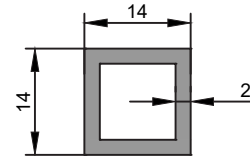

<b>3531</b>
14'lük Emniyet Çubuğu
0,260 kg/m

★ Yandaki profil birim ağırlıkları, bilgisayarla hesaplanmış teorik ağırlıklardır.

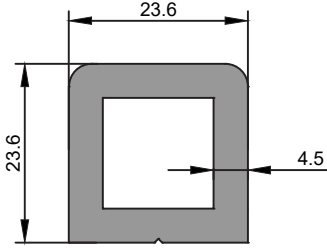
**4040**

Küpeşte Profil

0,921 kg/m

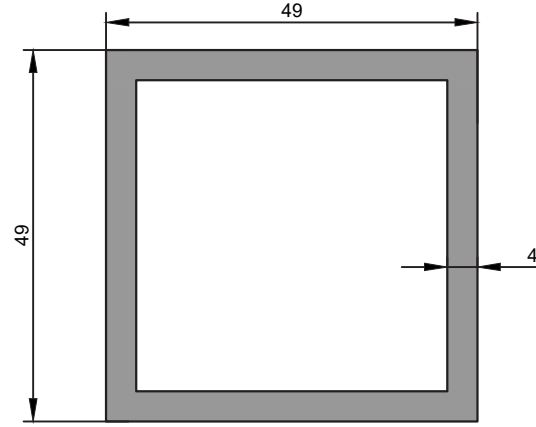
**4041**

Küpeşte Profil

1,951 kg/m

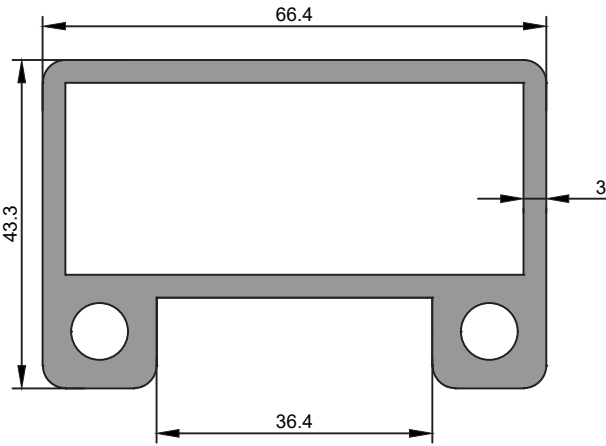
**4042**

Küpeşte Profil

2,196 kg/m

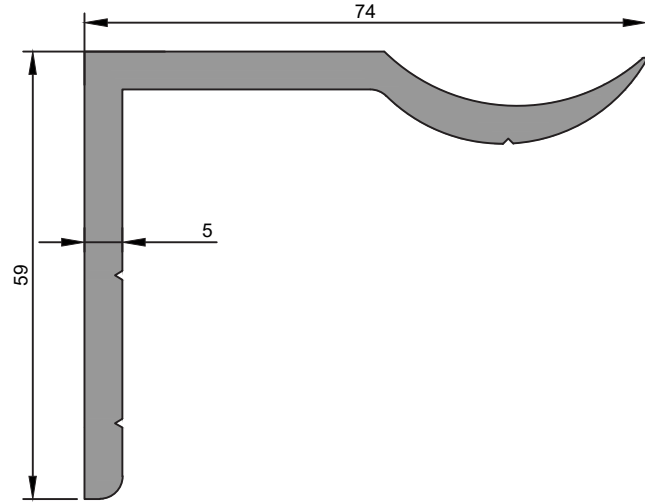
**4043**

Küpeşte Profil

1,680 kg/m

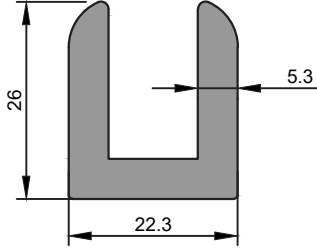

★ Yandaki profil birim ağırlıkları, bilgisayarla hesaplanmış teorik ağırlıklardır.

**4044**

Alt Profil Kapak

0,058 kg/m

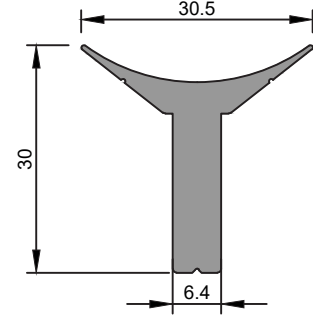
**4045**

Küpeşte Profil

0,586 kg/m

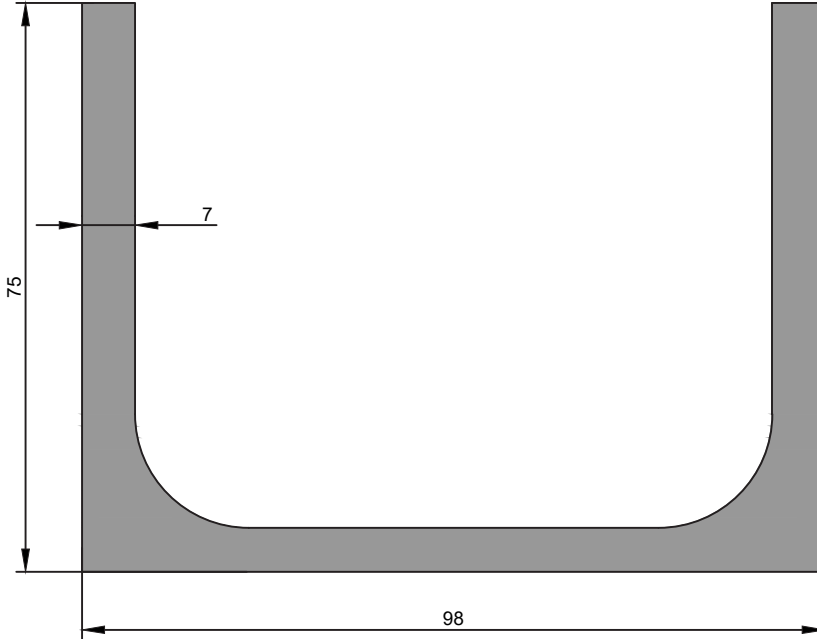
**4046**

Küpeşte Profil

4,427 kg/m

★ Yandaki profil birim ağırlıkları, bilgisayararda hesaplanmış teorik ağırlıklardır.

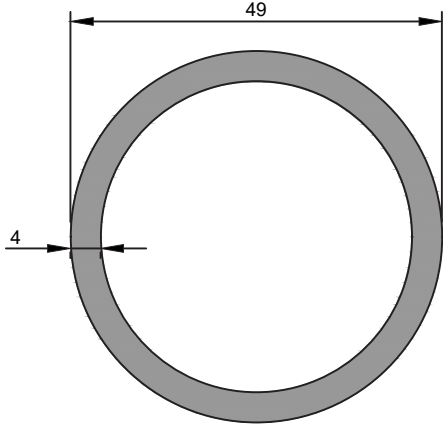

<b>4047</b>
Küpeşte Profil
1,533 kg/m

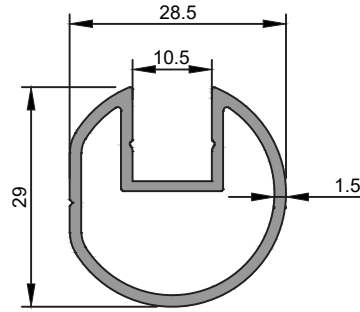

<b>4360</b>
Küpeşte Profil
0,450 kg/m

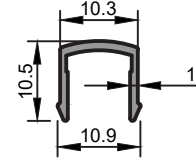

<b>4361</b>
Küpeşte Profil
0,077 kg/m

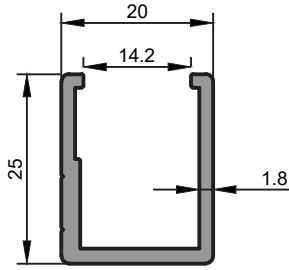

<b>4362</b>
Küpeşte Profil
0,363 kg/m

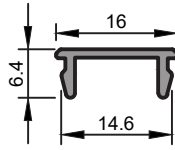

<b>4363</b>
Küpeşte Profil
0,087 kg/m

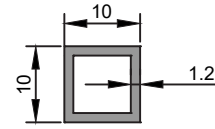

<b>4364</b>
Küpeşte Profil
0,114 kg/m

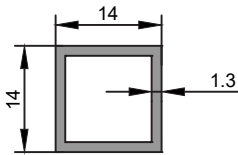

<b>4365</b>
Küpeşte Profil
0,179 kg/m

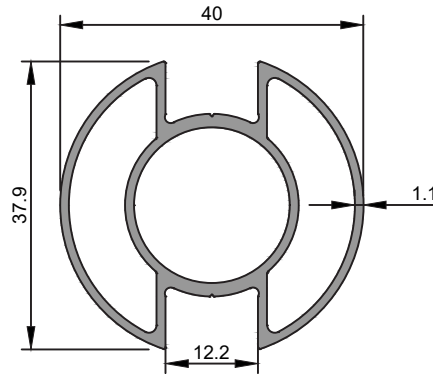

<b>4366</b>
Küpeşte Profil
0,683 kg/m

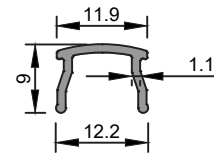

<b>4367</b>
Küpeşte Profil
0,081 kg/m

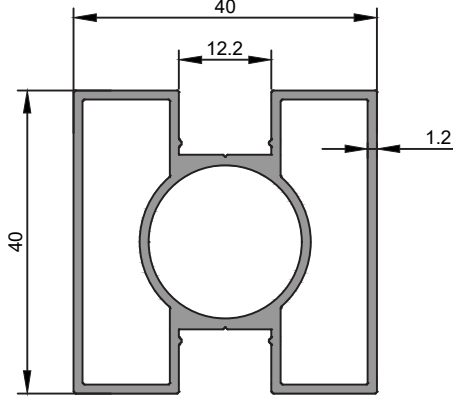
**4368**

Küpeşte Profil

0,824 kg/m

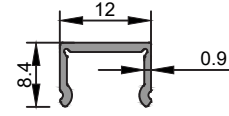
**4369**

Küpeşte Profil

0,076 kg/m

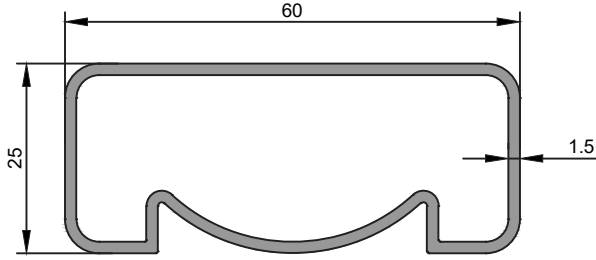
**4370**

Küpeşte Profil

0,704 kg/m

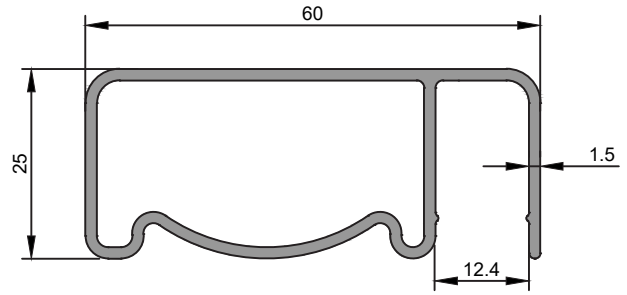
**4371**

Küpeşte Profil

0,718 kg/m

★ Yandaki profil birim ağırlıkları, bilgisayararda hesaplanmış teorik ağırlıklardır.





## PROFİL KATALOĐU







# CAM KÜPEŐTE PROFİLLERİ

GLASS HANDRAILS PROFILES

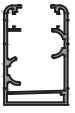
★ Profil Ađırlıkları Teorik Olup Teslim Anındaki Ađırlık Geçerlidir

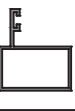
★ *Weight of profiles are theoretical, net weight will valid at the time of delivery.*

★ Yandaki profil birim ağırlıkları, bilgisayarda hesaplanmış teorik ağırlıklardır.

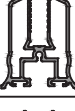
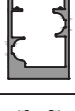
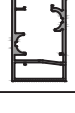
PROFİL KESİTİ	PROFİL KODU	PROFİL ADI	AĞIRLIK	ATALET MOMENTLERİ		SAYFA NO
				$J_x$ (cm <sup>4</sup> )	$J_y$ (cm <sup>4</sup> )	
	3973	Küpeşte Profili	3,261 kg/m	...	...	
	3097	Küpeşte Profili	1,302 kg/m	...	...	
	2572	Küpeşte Profili	0,135 kg/m	...	...	
	2573	Küpeşte Profili	0,214 kg/m	...	...	
	3095	Küpeşte Profili	0,423 kg/m	...	...	
	3096	Küpeşte Profili	0,877 kg/m	...	...	
	2769	Küpeşte Profili	0,442 kg/m	...	...	
	2575	Küpeşte Profili	0,460 kg/m	...	...	
	2576	Küpeşte Profili	0,921 kg/m	...	...	
	2771	Küpeşte Profili	0,805 kg/m	...	...	
	2574	Küpeşte Profili	1,490 kg/m	...	...	
	2770	Küpeşte Profili	1,507 kg/m	...	...	

★ Yandaki profil birim ağırlıkları, bilgisayarla hesaplanmış teorik ağırlıklardır.

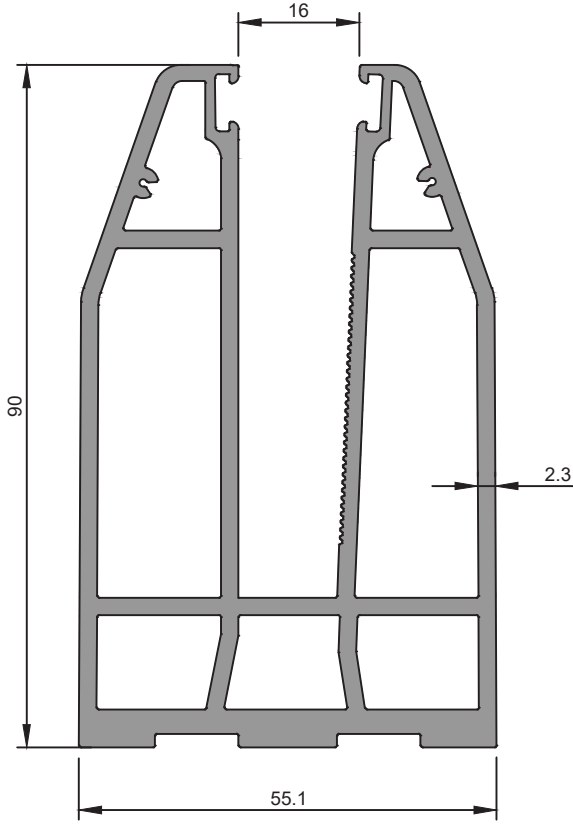

<b>3973</b>
Küpeşte Profil
3,261 kg/m

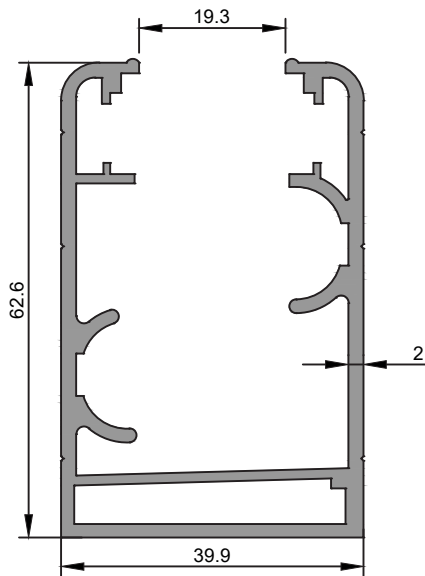

<b>3097</b>
Küpeşte Profil
1,302 kg/m

★ Yandaki profil birim ağırlıkları, bilgisayarla hesaplanmış teorik ağırlıklardır.

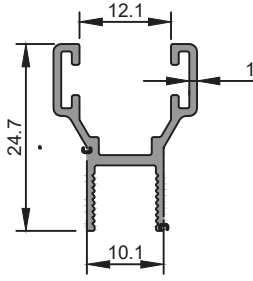

<b>2573</b>
Küpeşte Profil
0,214 kg/m

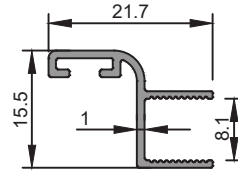

<b>2572</b>
Küpeşte Profil
0,135 kg/m

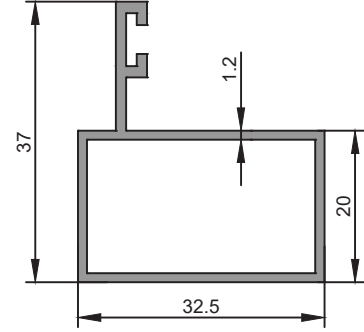

<b>3095</b>
Küpeşte Profil
0,423 kg/m

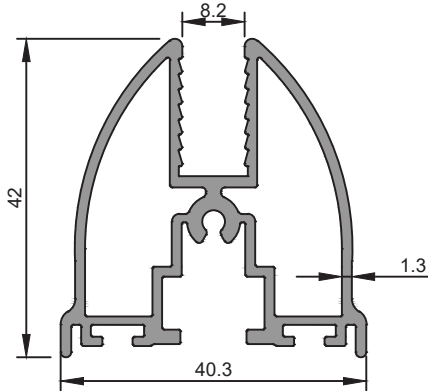

<b>3096</b>
Küpeşte Profil
0,877 kg/m

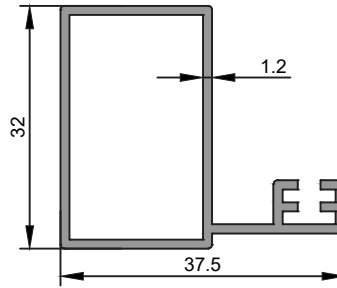

<b>2769</b>
Küpeşte Profil
0,442 kg/m

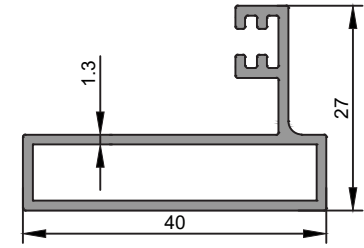

<b>2575</b>
Küpeşte Profil
0,460 kg/m



★ Yandaki profil birim ağırlıkları, bilgisayarda hesaplanmış teorik ağırlıklardır.

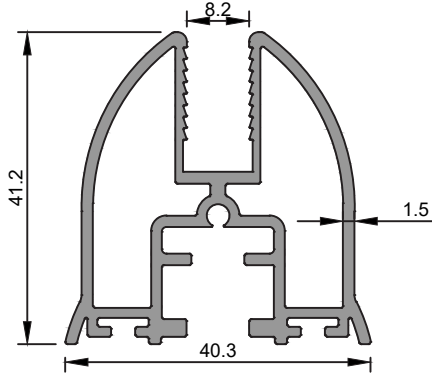

<b>2576</b>
Küpeşte Profil
0,921 kg/m

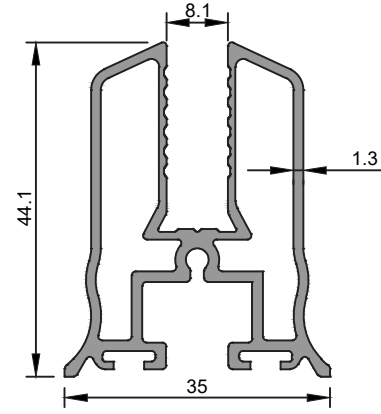

<b>2771</b>
Küpeşte Profil
0,805 kg/m

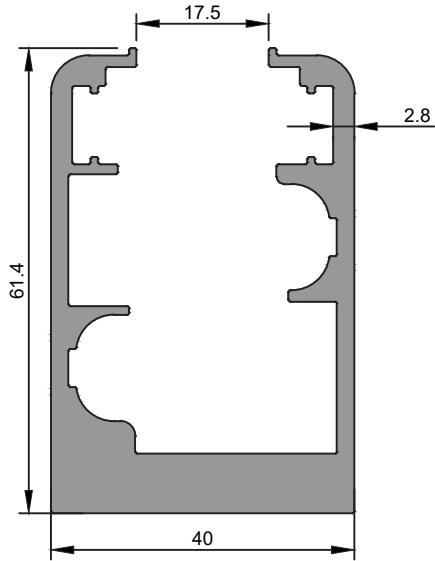

<b>2574</b>
Küpeşte Profil
1,490 kg/m

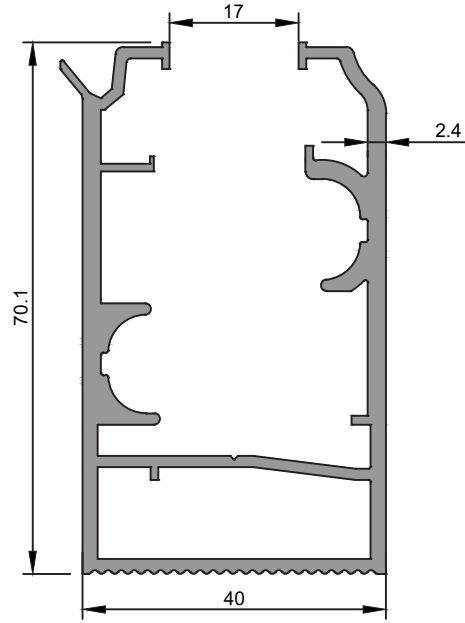

<b>2770</b>
Küpeşte Profil
1,507 kg/m





## PROFİL KATALOĐU















# MOBİLYA PROFİLLERİ

## FURNITURE PROFILES







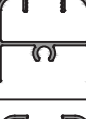
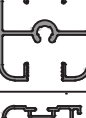
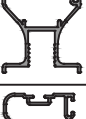

★ Profil Ağırlıkları Teorik Olup Teslim Anındaki Ağırlık Geçerlidir

★ *Weight of profiles are theoretical, net weight will valid at the time of delivery.*



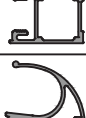
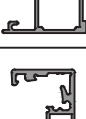
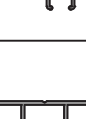
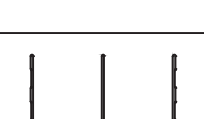

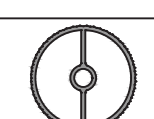



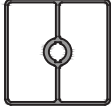
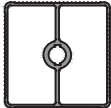
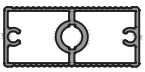

★ Yandaki profil birim ağırlıkları, bilgisayarda hesaplanmış teorik ağırlıklardır.

PROFİL KESİTİ	PROFİL KODU	PROFİL ADI	AĞIRLIK	ATALET MOMENTLERİ		SAYFA NO
				$J_x$ (cm <sup>4</sup> )	$J_y$ (cm <sup>4</sup> )	
	1960	...	0,261 kg/m	...	...	
	1961	...	0,396 kg/m	...	...	
	1962	...	0,242 kg/m	...	...	
	1116	...	0,244 kg/m	...	...	
	1631	...	0,589 kg/m	...	...	
	1996	...	0,265 kg/m	...	...	
	2007	...	0,262 kg/m	...	...	
	1975	...	0,487 kg/m	...	...	
	2024	...	0,474 kg/m	...	...	
	1664	...	0,260 kg/m	...	...	
	1596	...	0,347 kg/m	...	...	
	1641	...	0,331 kg/m	...	...	
	1965	...	0,362 kg/m	...	...	
	1598	...	0,305 kg/m	...	...	



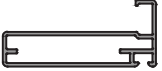







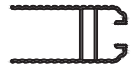
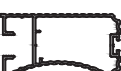

★ Yandaki profil birim ağırlıkları, bilgisayarda hesaplanmış teorik ağırlıklardır.

PROFİL KESİTİ	PROFİL KODU	PROFİL ADI	AĞIRLIK	ATALET MOMENTLERİ		SAYFA NO
				$J_x$ (cm <sup>4</sup> )	$J_y$ (cm <sup>4</sup> )	
	1956	...	0,356 kg/m	...	...	
	2045	...	0,221 kg/m	...	...	
	2046	...	0,276 kg/m	...	...	
	2050	...	0,358 kg/m	...	...	
	2048	...	0,442 kg/m	...	...	
	1665	...	0,495 kg/m	...	...	
	1813	...	0,466 kg/m	...	...	
	1581	...	0,392 kg/m	...	...	
	1148	...	0,389 kg/m	...	...	
	1180	...	0,283 kg/m	...	...	
	2049	...	0,222 kg/m	...	...	
	2045	...	0,519 kg/m	...	...	
	2047	...	0,385 kg/m	...	...	
	1249	...	0,733 kg/m	...	...	















★ Yandaki profil birim ağırlıkları, bilgisayarda hesaplanmış teorik ağırlıklardır.

PROFİL KESİTİ	PROFİL KODU	PROFİL ADI	AĞIRLIK	ATALET MOMENTLERİ		SAYFA NO
				$J_x$ (cm <sup>4</sup> )	$J_y$ (cm <sup>4</sup> )	
	1245	...	0,695 kg/m	...	...	
	1179	...	0,661 kg/m	...	...	
	1242	...	0,571 kg/m	...	...	
	1309	...	0,326 kg/m	...	...	
	1385	...	0,326 kg/m	...	...	
	1498	...	0,322 kg/m	...	...	
	1181	...	0,391 kg/m	...	...	
	1182	...	0,485 kg/m	...	...	
	1186	...	0,64 kg/m	...	...	
	1467	...	0,495 kg/m	...	...	
	1698	...	0,459 kg/m	...	...	
	1548	...	0,256 kg/m	...	...	
	1549	...	0,320 kg/m	...	...	
	1669	...	0,292 kg/m	...	...	

★ Yandaki profil birim ağırlıkları, bilgisayarda hesaplanmış teorik ağırlıklardır.













PROFİL KESİTİ	PROFİL KODU	PROFİL ADI	AĞIRLIK	ATALET MOMENTLERİ		SAYFA NO
				$J_x$ (cm <sup>4</sup> )	$J_y$ (cm <sup>4</sup> )	
	1670	...	0,340 kg/m	...	...	
	1276	...	0,346 kg/m	...	...	
	1278	...	0,497 kg/m	...	...	
	1668	...	0,528 kg/m	...	...	
	1550	...	0,425 kg/m	...	...	
	1551	...	0,508 kg/m	...	...	
	1620	...	0,209 kg/m	...	...	
	1663	...	0,60 kg/m	...	...	
	1666	...	0,434 kg/m	...	...	
	1546	...	0,445 kg/m	...	...	
	1547	...	0,236 kg/m	...	...	
	1279	...	0,603 kg/m	...	...	
	1277	...	0,228 kg/m	...	...	
	1671	...	0,376 kg/m	...	...	

★ Yandaki profil birim ağırlıkları, bilgisayarda hesaplanmış teorik ağırlıklardır.

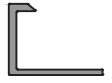
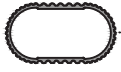











PROFİL KESİTİ	PROFİL KODU	PROFİL ADI	AĞIRLIK	ATALET MOMENTLERİ		SAYFA NO
				$J_x$ (cm <sup>4</sup> )	$J_y$ (cm <sup>4</sup> )	
	1392	...	0,263 kg/m	...	...	
	1393	...	0,276 kg/m	...	...	
	1360	...	0,146 kg/m	...	...	
	2035	...	0,379 kg/m	...	...	
	1661	...	0,239 kg/m	...	...	
	1662	...	0,167 kg/m	...	...	
	2033	...	0,156 kg/m	...	...	
	1816	...	0,135 kg/m	...	...	
	1963	...	0,147 kg/m	...	...	
	1964	...	0,224 kg/m	...	...	
	2043	...	0,299 kg/m	...	...	
	1141	...	0,208 kg/m	...	...	
	1815	...	0,167 kg/m	...	...	
	2031	...	0,309 kg/m	...	...	





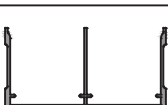

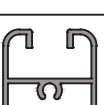
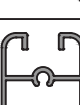





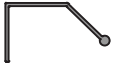

★ Yandaki profil birim ağırlıkları, bilgisayarda hesaplanmış teorik ağırlıklardır.

PROFİL KESİTİ	PROFİL KODU	PROFİL ADI	AĞIRLIK	ATALET MOMENTLERİ		SAYFA NO
				$J_x$ (cm <sup>4</sup> )	$J_y$ (cm <sup>4</sup> )	
	1824	...	0,219 kg/m	...	...	
	1968	...	0,101 kg/m	...	...	
	1974	...	0,79 kg/m	...	...	
	2085	...	0,92 kg/m	...	...	
	1766	...	0,69 kg/m	...	...	
	1049	...	0,63 kg/m	...	...	
	1376	...	0,234 kg/m	...	...	
	1377	...	0,218 kg/m	...	...	
	1957	...	0,197 kg/m	...	...	
	1449	...	0,190 kg/m	...	...	
	1291	...	0,311 kg/m	...	...	
	1814	...	0356 kg/m	...	...	
	2034	...	0,163 kg/m	...	...	
	1966	...	0,215 kg/m	...	...	









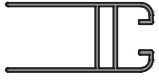

★ Yandaki profil birim ağırlıkları, bilgisayarda hesaplanmış teorik ağırlıklardır.

PROFİL KESİTİ	PROFİL KODU	PROFİL ADI	AĞIRLIK	ATALET MOMENTLERİ		SAYFA NO
				$J_x$ (cm <sup>4</sup> )	$J_y$ (cm <sup>4</sup> )	
	1967	...	0,192 kg/m	...	...	
	1667	...	0,312 kg/m	...	...	
	1715	...	0,106 kg/m	...	...	
	1954	...	0,288 kg/m	...	...	
	1689	...	0,222 kg/m	...	...	
	1716	...	0,170 kg/m	...	...	
	1859	...	0,282 kg/m	...	...	
	1608	...	0,538 kg/m	...	...	
	1684	...	0,822 kg/m	...	...	
	2032	...	0,530 kg/m	...	...	
	1741	...	0,294 kg/m	...	...	
	1742	...	0,360 kg/m	...	...	
	1530	...	0,549 kg/m	...	...	
	1638	...	0,676 kg/m	...	...	

★ Yandaki profil birim ağırlıkları, bilgisayarda hesaplanmış teorik ağırlıklardır.

PROFİL KESİTİ	PROFİL KODU	PROFİL ADI	AĞIRLIK	ATALET MOMENTLERİ		SAYFA NO
				$J_x$ (cm <sup>4</sup> )	$J_y$ (cm <sup>4</sup> )	
	1736	...	0,488 kg/m	...	...	
	1688	...	0,187 kg/m	...	...	
	1708	...	0,119 kg/m	...	...	
	1710	...	0,112 kg/m	...	...	
	1814	...	0,491 kg/m	...	...	
	1712	...	0,141 kg/m	...	...	
	1709	...	0,68 kg/m	...	...	
	1711	...	0,71 kg/m	...	...	
	1714	...	0,346 kg/m	...	...	
	1460	...	0,279 kg/m	...	...	
	1428	...	0,249 kg/m	...	...	
	1687	...	0,479 kg/m	...	...	
	1293	...	0,683 kg/m	...	...	
	1597	...	0,396 kg/m	...	...	

★ Yandaki profil birim ağırlıkları, bilgisayarda hesaplanmış teorik ağırlıklardır.

PROFİL KESİTİ	PROFİL KODU	PROFİL ADI	AĞIRLIK	ATALET MOMENTLERİ		SAYFA NO
				$J_x$ (cm <sup>4</sup> )	$J_y$ (cm <sup>4</sup> )	
	1743	...	0,506 kg/m	...	...	
	1713	...	0,259 kg/m	...	...	
	1898	...	0,291 kg/m	...	...	
	1899	...	0,463 kg/m	...	...	
	1900	...	0,434 kg/m	...	...	
	1901	...	0,394 kg/m	...	...	
	1306	...	0,351 kg/m	...	...	
	1307	...	0,310 kg/m	...	...	
	1727	...	0,312 kg/m	...	...	
	1427	...	0,430 kg/m	...	...	

★ Yandaki profil birim ağırlıkları, bilgisayarda hesaplanmış teorik ağırlıklardır.

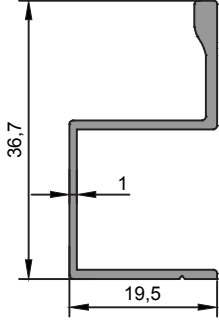

<b>1960</b>
0,261 kg/m

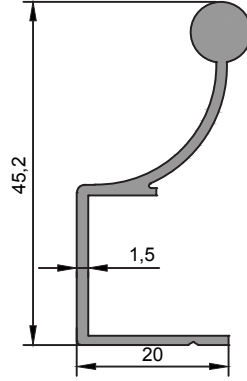

<b>1961</b>
0,396 kg/m

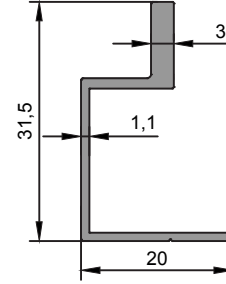

<b>1962</b>
0,242 kg/m

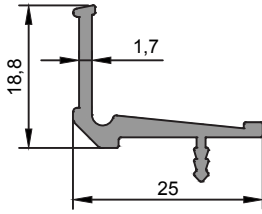

<b>1116</b>
0,244 kg/m

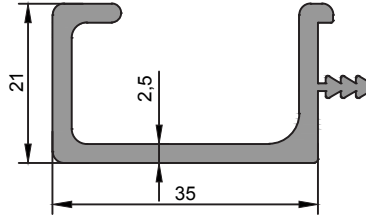

<b>1631</b>
0,589 kg/m

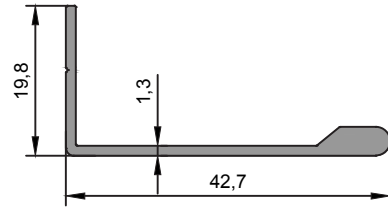

<b>1996</b>
0,265 kg/m

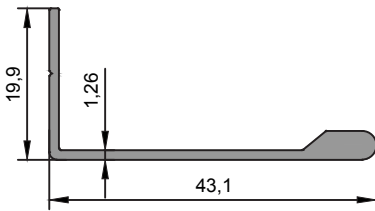

<b>2007</b>
0,262 kg/m

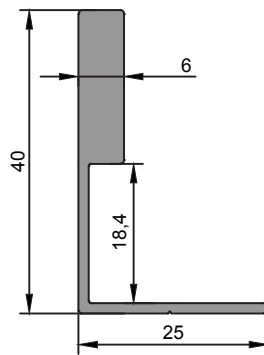

<b>1975</b>
0,487 kg/m

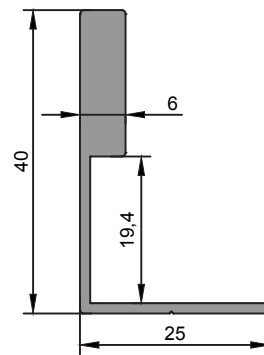

<b>2024</b>
0,474 kg/m

★ Yandaki profil birim ağırlıkları, bilgisayarda hesaplanmış teorik ağırlıklardır.

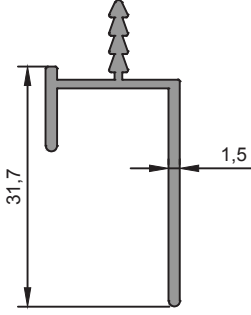
**1664**

0,260 kg/m

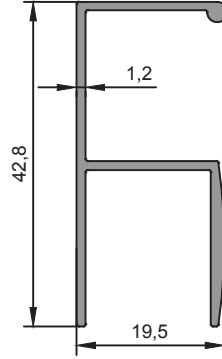
**1596**

0,347 kg/m

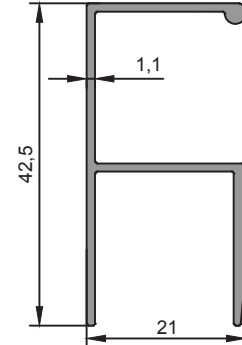
**1641**

0,331 kg/m

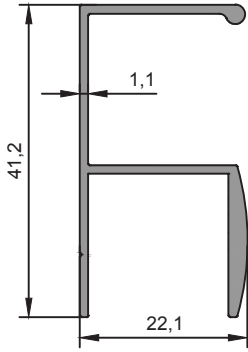
**1965**

0,362 kg/m

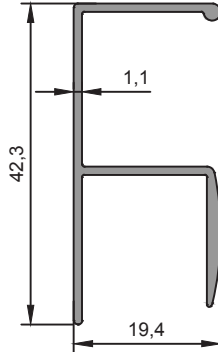
**1598**

0,305 kg/m

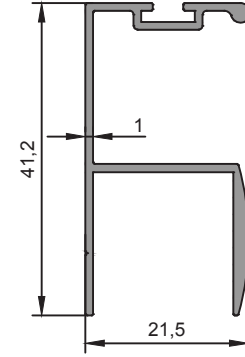
**1956**

0,336 kg/m

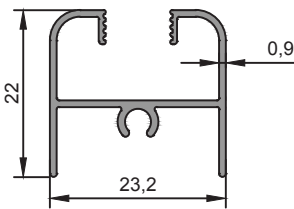
**2045**

0,221 kg/m

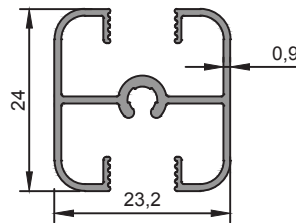

**2046**

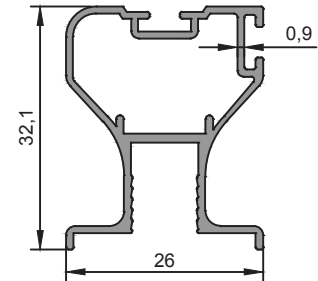
0,276 kg/m

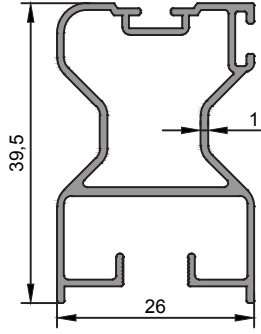

**2050**

0,358 kg/m

★ Yandaki profil birim ağırlıkları, bilgisayarda hesaplanmış teorik ağırlıklardır.

**2048**

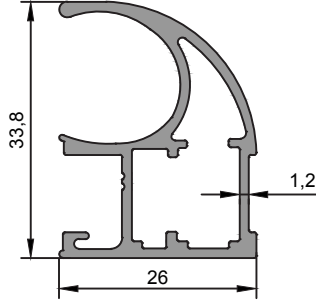
0,442 kg/m

**1665**

0,495 kg/m

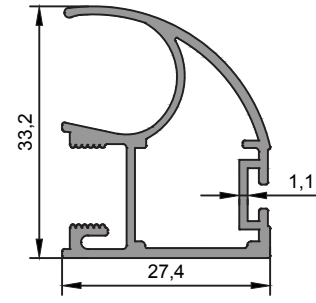
**1813**

0,466 kg/m

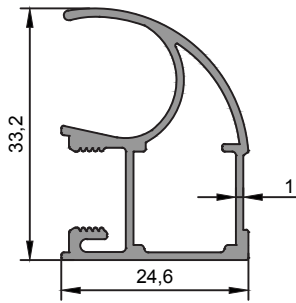
**1581**

0,392 kg/m

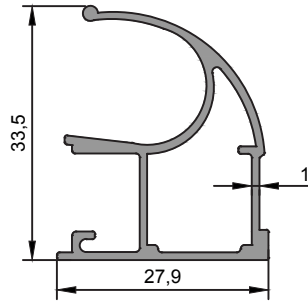
**1148**

0,389 kg/m

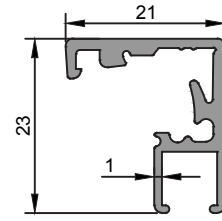
**1180**

0,283 kg/m

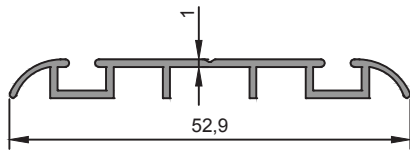

**2049**

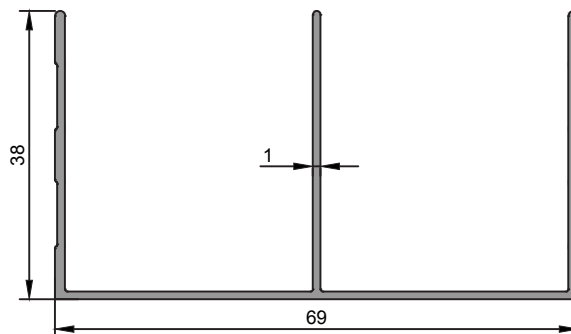
0,222 kg/m

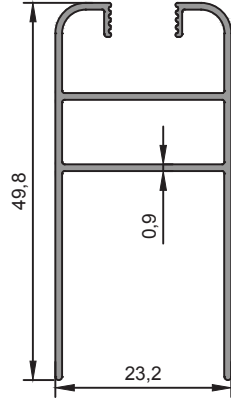

**2044**

0,519 kg/m

★ Yandaki profil birim ağırlıkları, bilgisayarda hesaplanmış teorik ağırlıklardır.

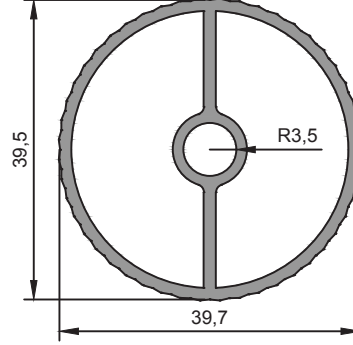

**2047**  
0,385 kg/m



**1249**  
0,733 kg/m

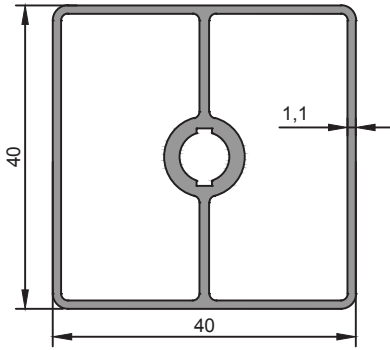

**1245**  
0,695 kg/m

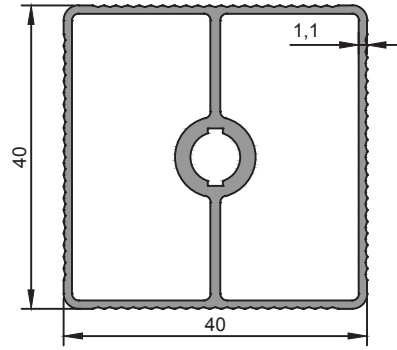

**1179**  
0,661 kg/m

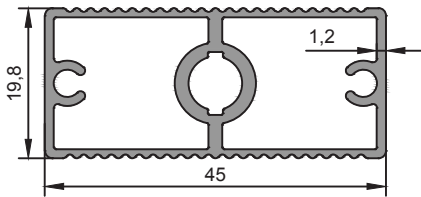

**1242**  
0,571 kg/m

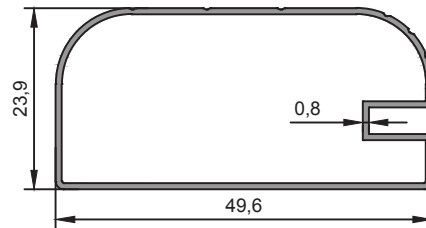

**1309**  
0,326 kg/m

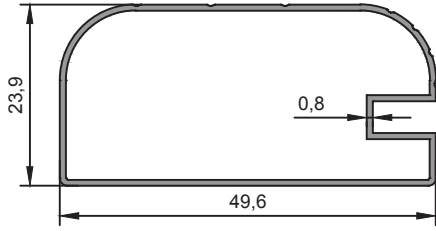

★ Yandaki profil birim ağırlıkları, bilgisayarla hesaplanmış teorik ağırlıklardır.

**1385**

0,326 kg/m

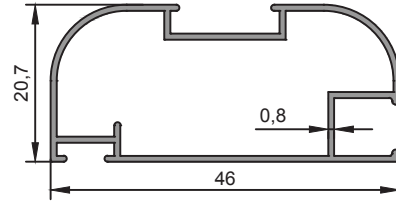
**1498**

0,322 kg/m

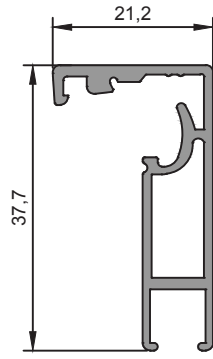
**1181**

0,391 kg/m

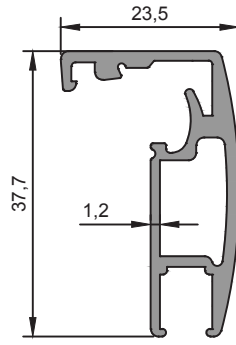
**1182**

0,485 kg/m

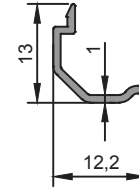
**1186**

0,64 kg/m

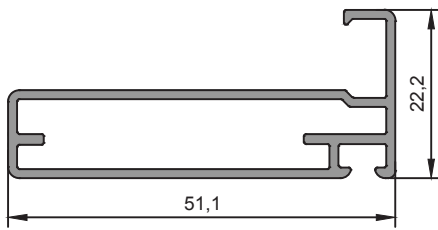
**1467**

0,495 kg/m

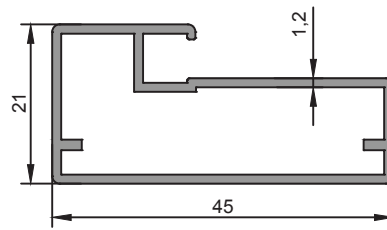
**1698**

0,459 kg/m

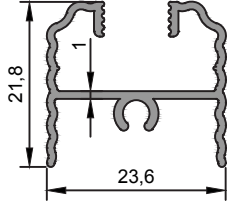
**1548**

0,256 kg/m

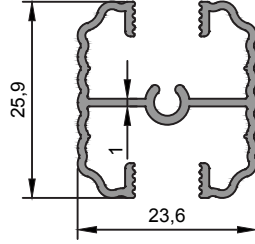
**1549**

0,320 kg/m

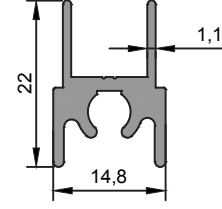
**1669**

0,292 kg/m

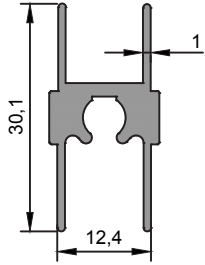
**1670**

0,340 kg/m

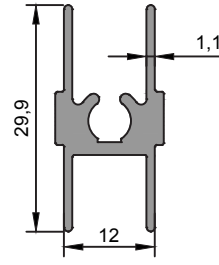
**1276**

0,346 kg/m

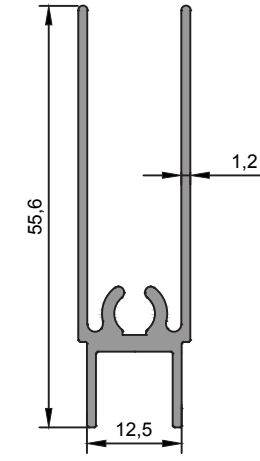
**1278**

0,497 kg/m

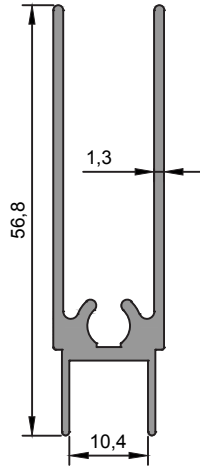
**1668**

0,528 kg/m

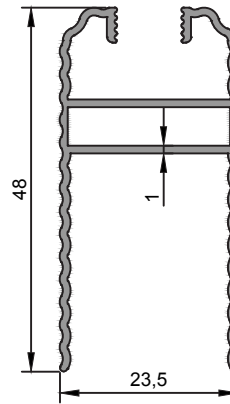

**1550**

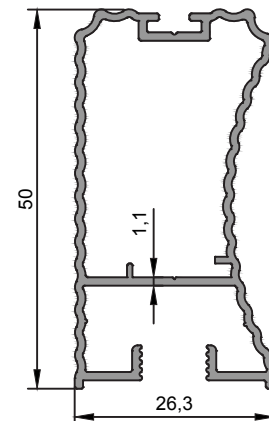
0,425 kg/m

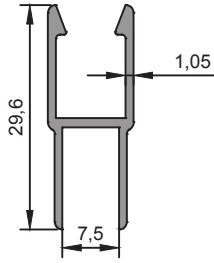

**1551**

0,508 kg/m

★ Yandaki profil birim ağırlıkları, bilgisayarda hesaplanmış teorik ağırlıklardır.

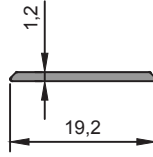

**1620**  
0,209 kg/m



**1663**  
0,60 kg/m

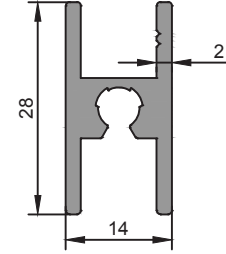

**1666**  
0,434 kg/m

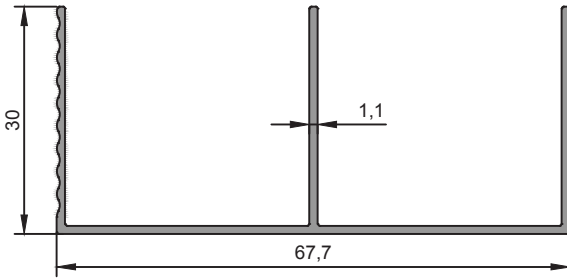

**1546**  
0,445 kg/m

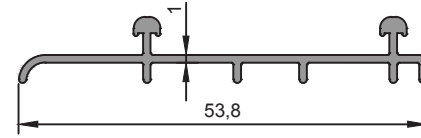

**1547**  
0,236 kg/m

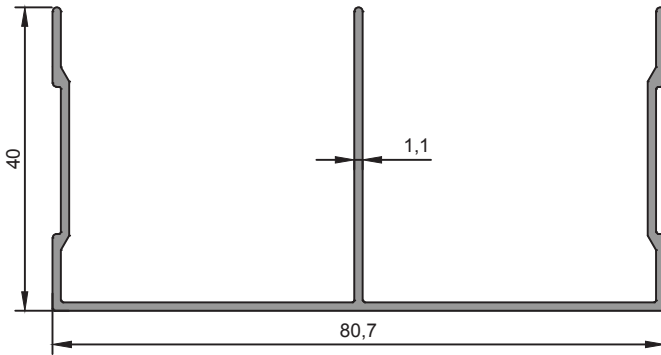

**1279**  
0,603 kg/m

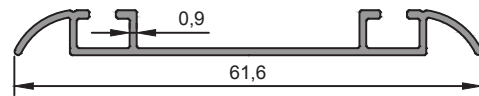

**1277**  
0,228 kg/m

★ Yandaki profil birim ağırlıkları, bilgisayarda hesaplanmış teorik ağırlıklardır.

★ Yandaki profil birim ağırlıkları, bilgisayarla hesaplanmış teorik ağırlıklardır.

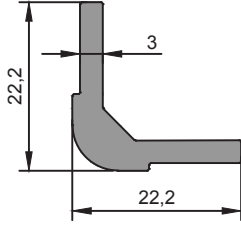
**1671**

0,376 kg/m

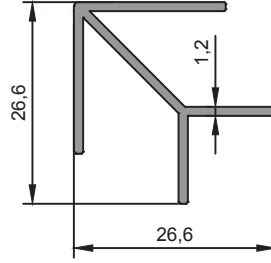
**1392**

0,263 kg/m

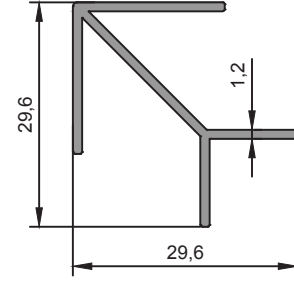
**1393**

0,276 kg/m

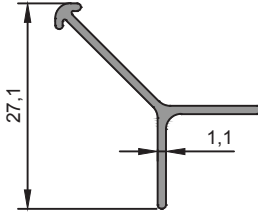
**1360**

0,146 kg/m

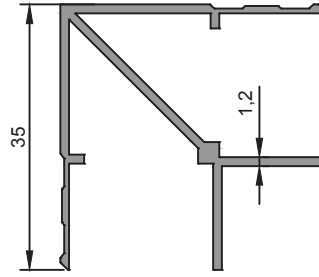
**2035**

0,379 kg/m

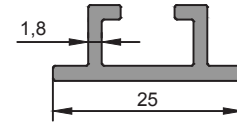
**1661**

0,239 kg/m

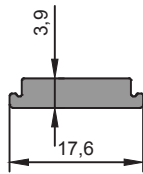
**1662**

0,167 kg/m

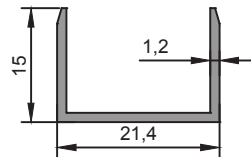

**2033**

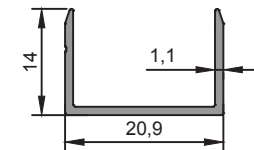
0,156 kg/m

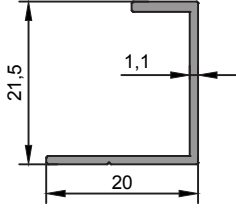

**1816**

0,135 kg/m

★ Yandaki profil birim ağırlıkları, bilgisayarda hesaplanmış teorik ağırlıklardır.

**1963**

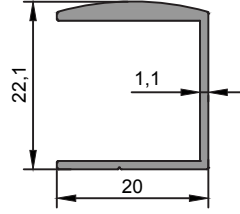
0,147 kg/m

**1964**

0,224 kg/m

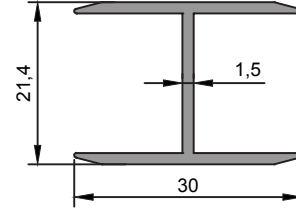
**2043**

0,299 kg/m

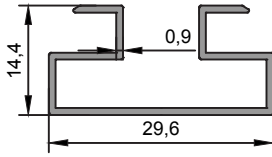
**1141**

0,208 kg/m

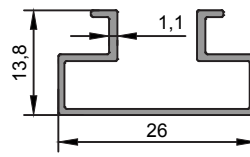
**1815**

0,167 kg/m

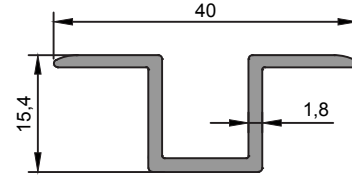
**2031**

0,309 kg/m

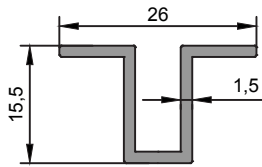
**1824**

0,219 kg/m

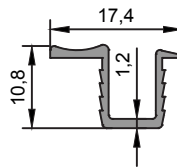

**1968**

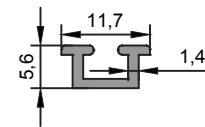
0,101 kg/m

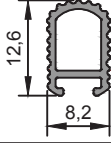

**1974**

0,79 kg/m

★ Yandaki profil birim ağırlıkları, bilgisayararda hesaplanmış teorik ağırlıklardır.

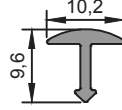

<b>2085</b>
0,92 kg/m



<b>1766</b>
0,69 kg/m

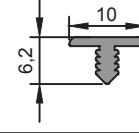

<b>1049</b>
0,63 kg/m

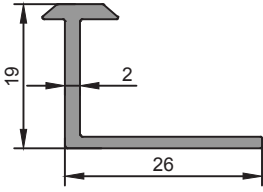

<b>1376</b>
0,234 kg/m

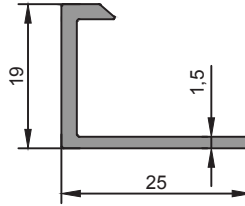

<b>1377</b>
0,218 kg/m

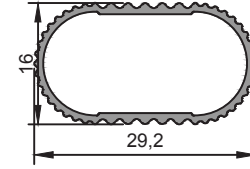

<b>1957</b>
0,197 kg/m

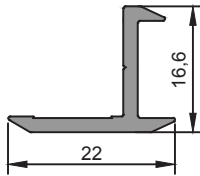

<b>1449</b>
0,190 kg/m

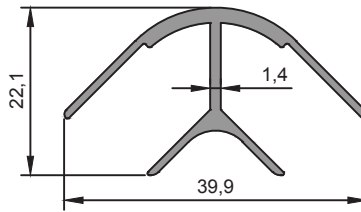

<b>1291</b>
0,311 kg/m

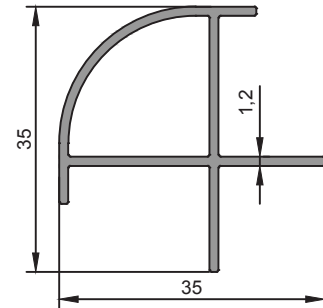

<b>1814</b>
0,356 kg/m

★ Yandaki profil birim ağırlıkları, bilgisayarda hesaplanmış teorik ağırlıklardır.

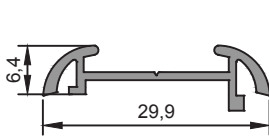
**2034**

0,163 kg/m

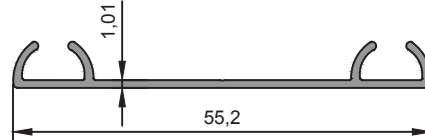
**1966**

0,215 kg/m

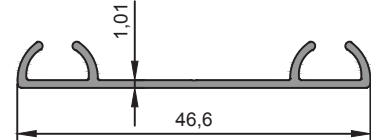
**1967**

0,192 kg/m

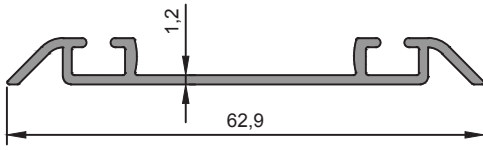
**1667**

0,312 kg/m

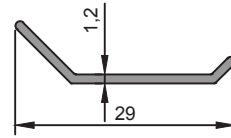
**1715**

0,106 kg/m

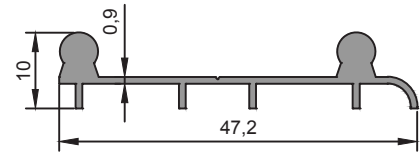
**1954**

0,288 kg/m

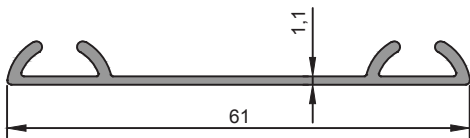
**1689**

0,222 kg/m

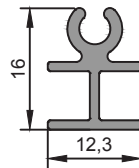

**1716**

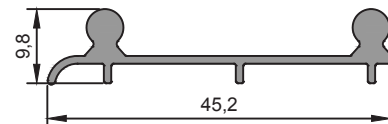
0,170 kg/m

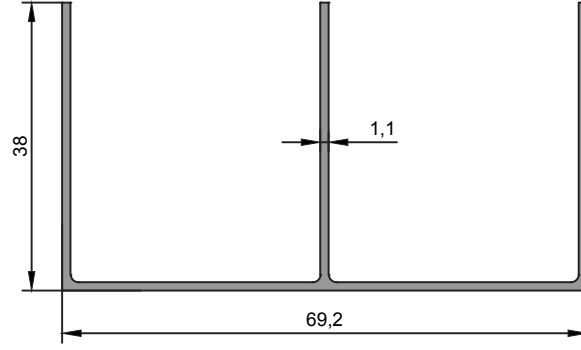

**1859**

0,282 kg/m

★ Yandaki profil birim ağırlıkları, bilgisayarla hesaplanmış teorik ağırlıklardır.

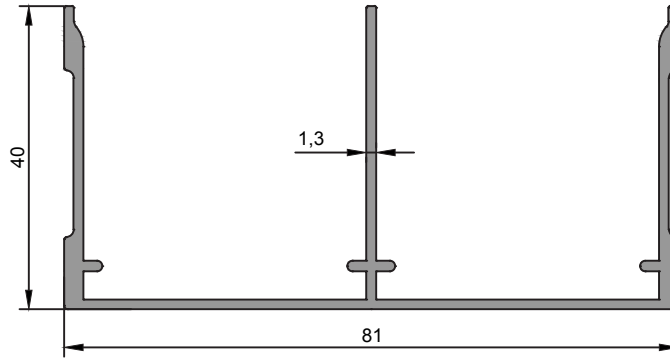

<b>1608</b>
0,538 kg/m



<b>1684</b>
0,822 kg/m

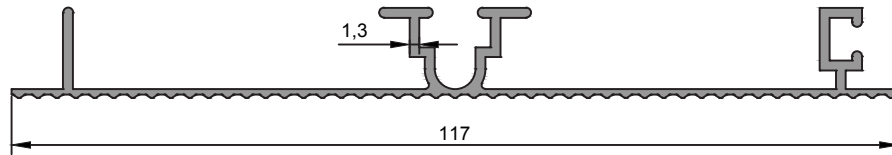

<b>2032</b>
0,530 kg/m

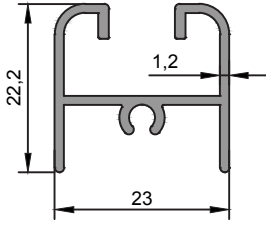

★ Yandaki profil birim ağırlıkları, bilgisayarda hesaplanmış teorik ağırlıklardır.

**1741**

0,294 kg/m

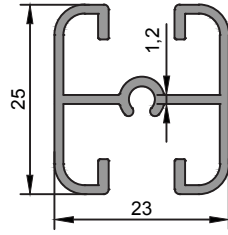
**1742**

0,360 kg/m

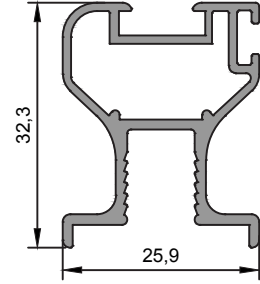
**1530**

0,549 kg/m

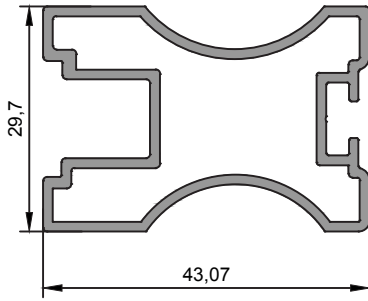
**1638**

0,676 kg/m

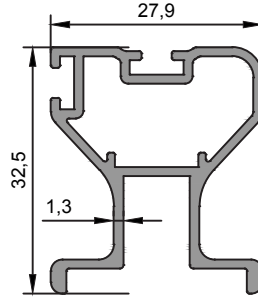
**1736**

0,488 kg/m

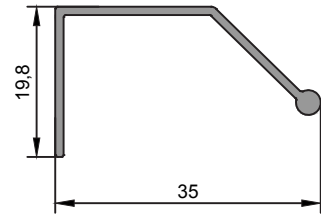
**1688**

0,187 kg/m

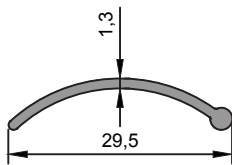
**1708**

0,119 kg/m

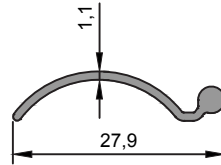

**1710**

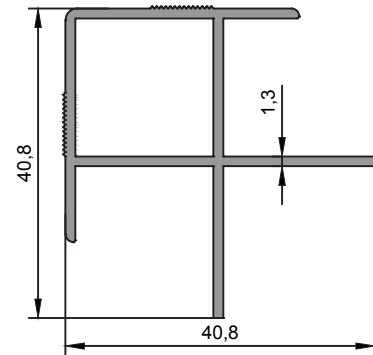
0,112 kg/m

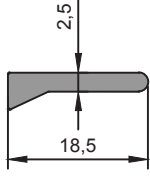

**1814**

0,491 kg/m

★ Yandaki profil birim ağırlıkları, bilgisayarda hesaplanmış teorik ağırlıklardır.

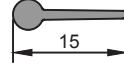

**1712**  
0,141 kg/m



**1709**  
0,68 kg/m

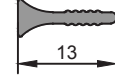

**1711**  
0,71kg/m

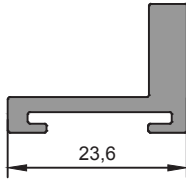

**1714**  
0,346 kg/m

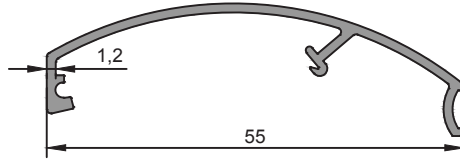

**1460**  
0,279 kg/m

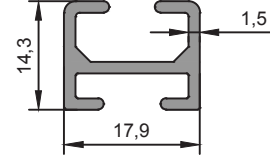

**1428**  
0,249 kg/m

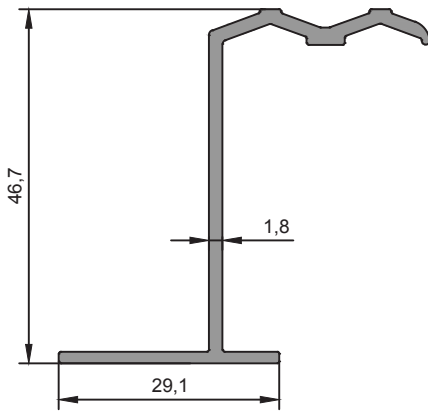

**1687**  
0,479 kg/m

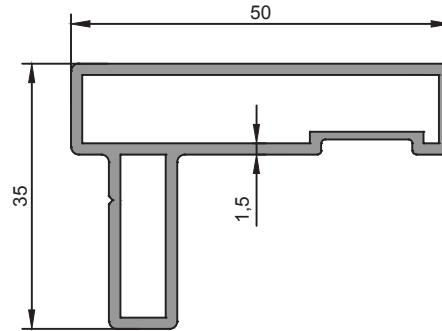

**1293**  
0,683 kg/m

★ Yandaki profil birim ağırlıkları, bilgisayarda hesaplanmış teorik ağırlıklardır.

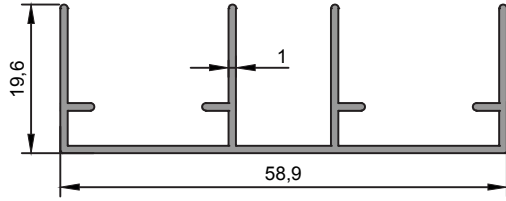

<b>1597</b>
0,396 kg/m

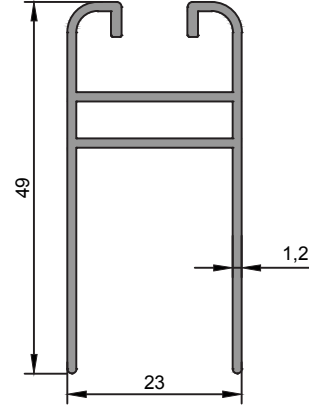

<b>1743</b>
0,506 kg/m

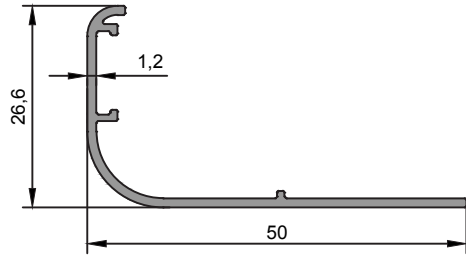

<b>1713</b>
0,259 kg/m

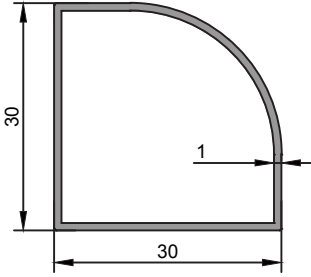

<b>1898</b>
0,291 kg/m

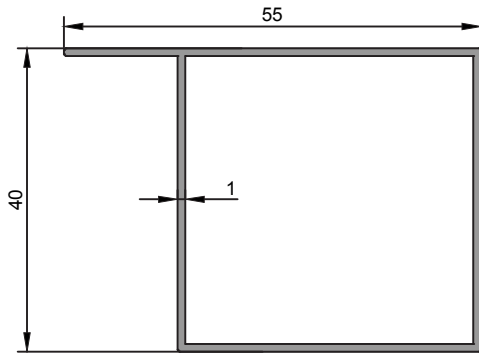

<b>1899</b>
0,463 kg/m

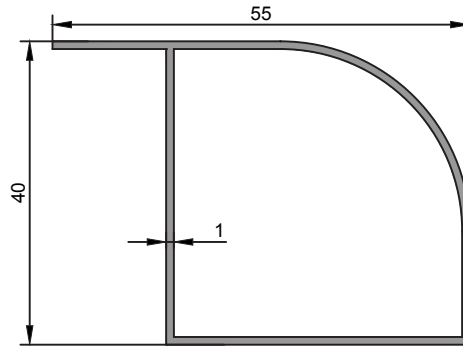

<b>1900</b>
0,434 kg/m

★ Yandaki profil birim ağırlıkları, bilgisayarda hesaplanmış teorik ağırlıklardır.

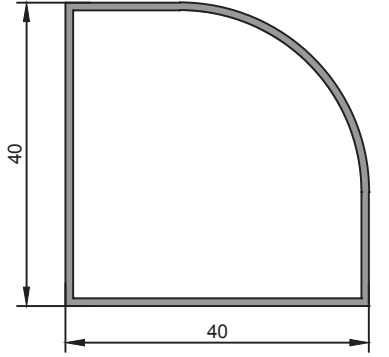

**1901**  
0,394 kg/m

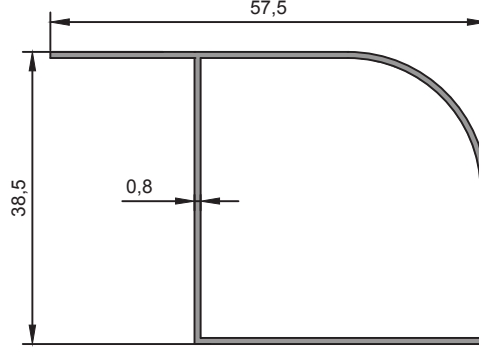

**1306**  
0,351 kg/m

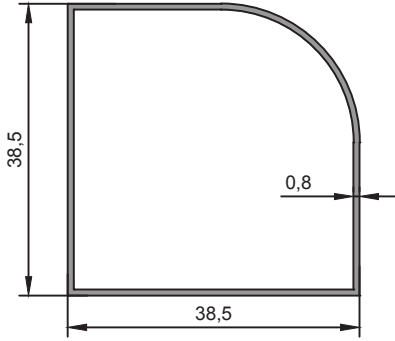

**1307**  
0,310 kg/m

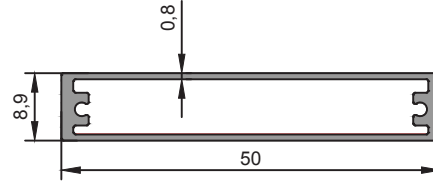

**1727**  
0,312 kg/m

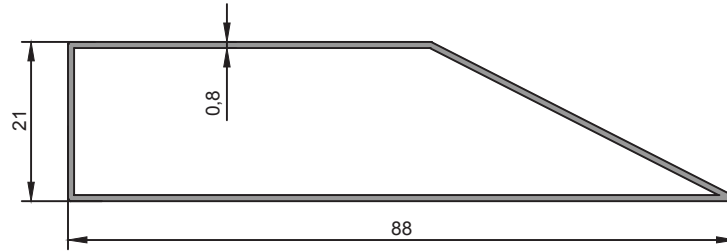

**1427**  
0,430 kg/m



## PROFİL KATALOĐU















# SERAMİK PROFİLLERİ

## CERAMIC PROFILES















★ Profil Ağırlıkları Teorik Olup Teslim Anındaki Ağırlık Geçerlidir

★ *Weight of profiles are theoretical, net weight will valid at the time of delivery.*











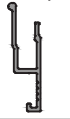

★ Yandaki profil birim ağırlıkları, bilgisayarda hesaplanmış teorik ağırlıklardır.

PROFİL KESİTİ	PROFİL KODU	PROFİL ADI	AĞIRLIK	ATALET MOMENTLERİ		SAYFA NO
				$J_x$ (cm <sup>4</sup> )	$J_y$ (cm <sup>4</sup> )	
	1755	...	0,290 kg/m	...	...	
	1756	...	0,319 kg/m	...	...	
	1121	...	0,486 kg/m	...	...	
	1222	...	0,490 kg/m	...	...	
	1831	...	1,199 kg/m	...	...	
	1832	...	0,235 kg/m	...	...	
	1833	...	0,293 kg/m	...	...	
	1834	...	0,288 kg/m	...	...	
	2842	...	0,947 kg/m	...	...	
	1255	...	0,603 kg/m	...	...	
	1477	...	0,956 kg/m	...	...	
	1394	...	0,479 kg/m	...	...	
	1801	...	0,801 kg/m	...	...	
	1840	...	0,308 kg/m	...	...	

★ Yandaki profil birim ağırlıkları, bilgisayarda hesaplanmış teorik ağırlıklardır.













PROFİL KESİTİ	PROFİL KODU	PROFİL ADI	AĞIRLIK	ATALET MOMENTLERİ		SAYFA NO
				$J_x$ (cm <sup>4</sup> )	$J_y$ (cm <sup>4</sup> )	
	1033	...	0,421 kg/m	...	...	
	1592	...	0,569 kg/m	...	...	
	1747	...	0,558 kg/m	...	...	
	1170	...	0,578 kg/m	...	...	
	1158	...	0,560 kg/m	...	...	
	1797	...	0,742 kg/m	...	...	
	1192	...	1,093 kg/m	...	...	
	1193	...	0,280 kg/m	...	...	
	1884	...	0,448 kg/m	...	...	
	1882	...	0,278 kg/m	...	...	
	1883	...	0,318 kg/m	...	...	
	1543	...	0,427 kg/m	...	...	
	1544	...	0,297 kg/m	...	...	
	1358	...	0,226 kg/m	...	...	

★ Yandaki profil birim ağırlıkları, bilgisayarda hesaplanmış teorik ağırlıklardır.

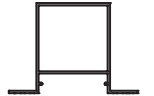
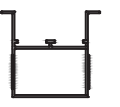

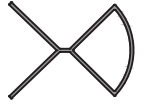
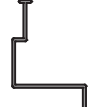

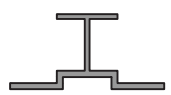





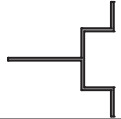



PROFİL KESİTİ	PROFİL KODU	PROFİL ADI	AĞIRLIK	ATALET MOMENTLERİ		SAYFA NO
				$J_x$ (cm <sup>4</sup> )	$J_y$ (cm <sup>4</sup> )	
	1733	...	0,477 kg/m	...	...	
	1734	...	0,553 kg/m	...	...	
	1753	...	0,700 kg/m	...	...	
	1476	...	0,220 kg/m	...	...	
	1261	...	1,329 kg/m	...	...	
	1335	...	0,433 kg/m	...	...	
	1464	...	0,435 kg/m	...	...	
	1649	...	0,278 kg/m	...	...	
	1364	...	0,333 kg/m	...	...	
	1366	...	0,133 kg/m	...	...	
	1754	...	0,718 kg/m	...	...	
	1566	...	0,696 kg/m	...	...	
	1565	...	1,051 kg/m	...	...	
	1316	...	0,563 kg/m	...	...	





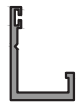







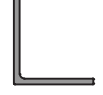

★ Yandaki profil birim ağırlıkları, bilgisayarda hesaplanmış teorik ağırlıklardır.

PROFİL KESİTİ	PROFİL KODU	PROFİL ADI	AĞIRLIK	ATALET MOMENTLERİ		SAYFA NO
				$J_x$ (cm <sup>4</sup> )	$J_y$ (cm <sup>4</sup> )	
	1748	...	0,394 kg/m	...	...	
	1368	...	0,394 kg/m	...	...	
	1692	...	0,540 kg/m	...	...	
	1682	...	0,139 kg/m	...	...	
	1355	...	0,541 kg/m	...	...	
	1354	...	0,751 kg/m	...	...	
	2098	...	1,095 kg/m	...	...	
	1632	...	1,407 kg/m	...	...	
	1482	...	1,449 kg/m	...	...	
	1798	...	1,215 kg/m	...	...	
	1978	...	0,517 kg/m	...	...	
	3776	...	0,494 kg/m	...	...	
	3777	...	0,269 kg/m	...	...	
	3778	...	0,378 kg/m	...	...	

★ Yandaki profil birim ağırlıkları, bilgisayarda hesaplanmış teorik ağırlıklardır.

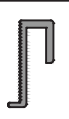
PROFİL KESİTİ	PROFİL KODU	PROFİL ADI	AĞIRLIK	ATALET MOMENTLERİ		SAYFA NO
				$J_x$ (cm <sup>4</sup> )	$J_y$ (cm <sup>4</sup> )	
	3192	...	0,910 kg/m	...	...	
	3220	...	0,484 kg/m	...	...	
	3221	...	0,268 kg/m	...	...	
	3222	...	0,220 kg/m	...	...	
	3668	...	0,563 kg/m	...	...	
	3748	...	0,748 kg/m	...	...	
	3802	...	1,257 kg/m	...	...	
	3954	...	0,334 kg/m	...	...	
	3955	...	0,436 kg/m	...	...	
	3999	...	0,708 kg/m	...	...	
	4015	...	0,461 kg/m	...	...	
	4016	...	0,488 kg/m	...	...	
	4798	...	0,131 kg/m	...	...	
	4068	...	0,640 kg/m	...	...	

★ Yandaki profil birim ağırlıkları, bilgisayarda hesaplanmış teorik ağırlıklardır.

PROFİL KESİTİ	PROFİL KODU	PROFİL ADI	AĞIRLIK	ATALET MOMENTLERİ		SAYFA NO
				$J_x$ (cm <sup>4</sup> )	$J_y$ (cm <sup>4</sup> )	
	2637	...	0,954 kg/m	...	...	
	2999	...	0,594 kg/m	...	...	
	2634	...	0,909 kg/m	...	...	
	2635	...	1,500 kg/m	...	...	
	2636	...	1,074 kg/m	...	...	
	1365	...	1,168 kg/m	...	...	
	1367	...	1,379 kg/m	...	...	
	1369	...	1,802 kg/m	...	...	
	1370	...	1,590 kg/m	...	...	
	2900	...	0,353 kg/m	...	...	
	2901	...	0,297 kg/m	...	...	
	3025	...	0,871 kg/m	...	...	
	3026	...	1,531 kg/m	...	...	
	3222	...	0,220 kg/m	...	...	



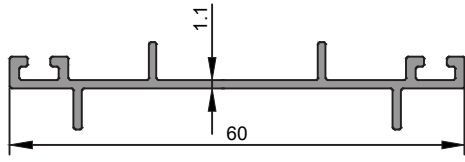

**1755**

0,290 kg/m

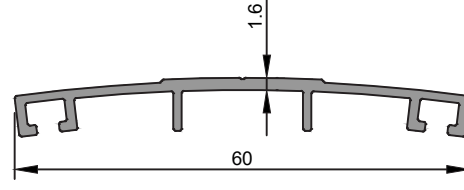

**1756**

0,319 kg/m

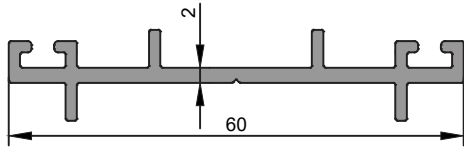

**1121**

0,486 kg/m

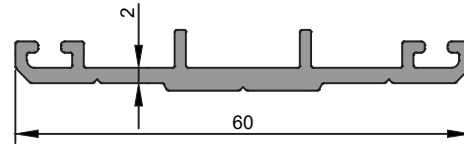

**1222**

0,490 kg/m

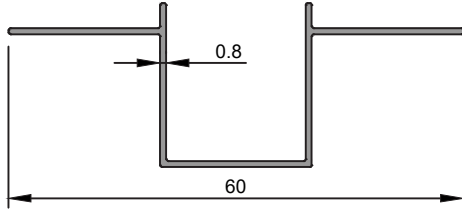

**1831**

0,220 kg/m

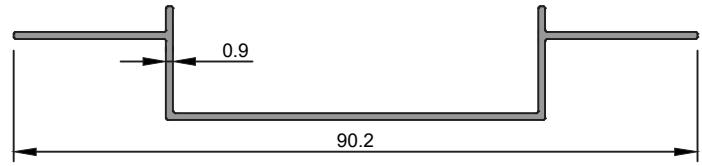

**1834**

0,288 kg/m

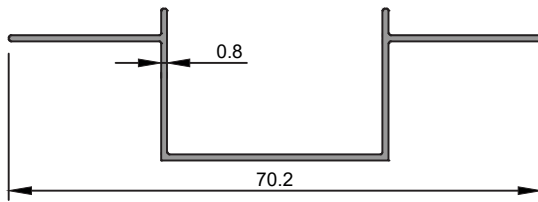

**1832**

0,235 kg/m

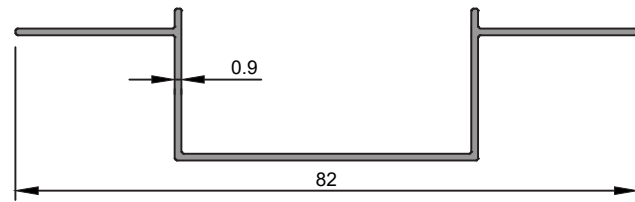

**1833**

0,293 kg/m

★ Yandaki profil birim ağırlıkları, bilgisayarla hesaplanmış teorik ağırlıklardır.

★ Yandaki profil birim ağırlıkları, bilgisayarla hesaplanmış teorik ağırlıklardır.

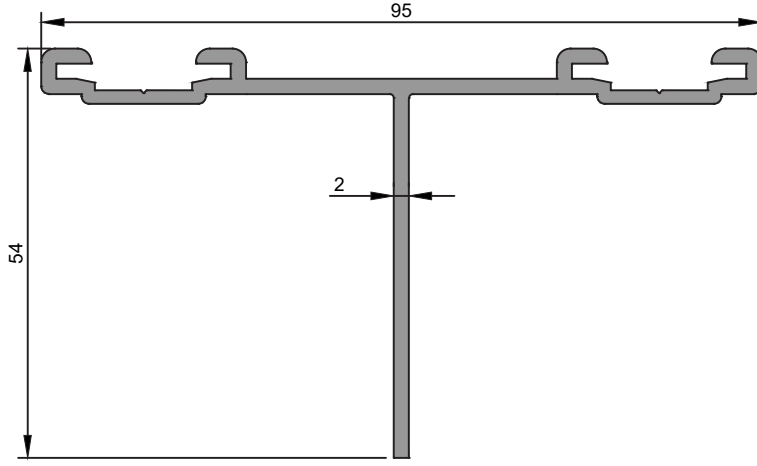

<b>1060</b>
0,947 kg/m

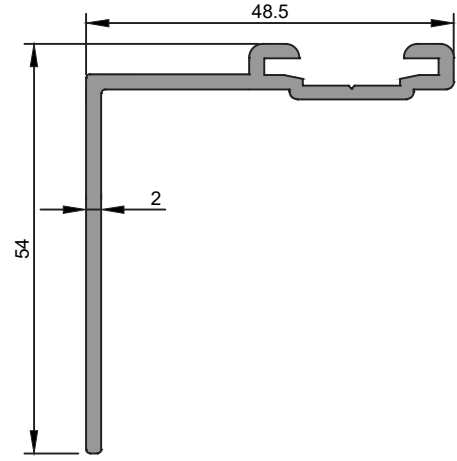

<b>1255</b>
0,603 kg/m

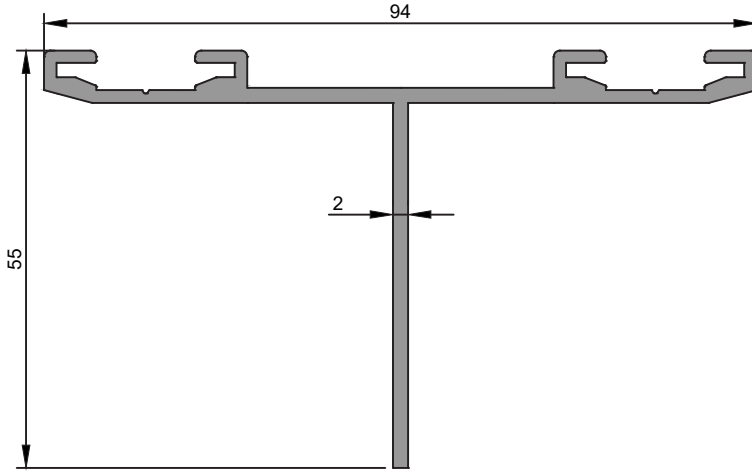

<b>1477</b>
0,956 kg/m

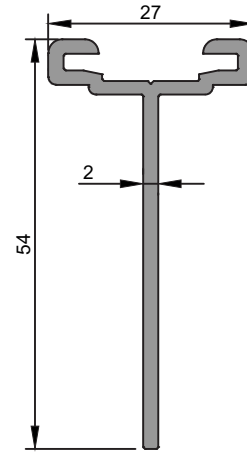

<b>1394</b>
0,479 kg/m

★ Yandaki profil birim ağırlıkları, bilgisayarla hesaplanmış teorik ağırlıklardır.

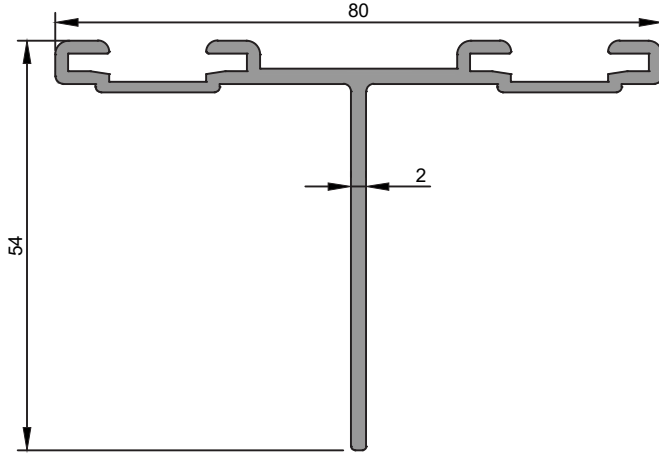

<b>1801</b>
0,805 kg/m

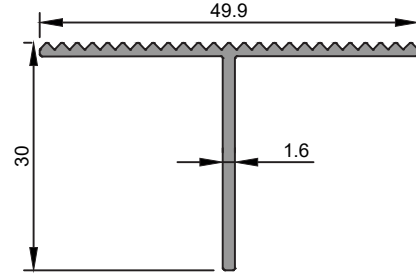

<b>1840</b>
0,308 kg/m

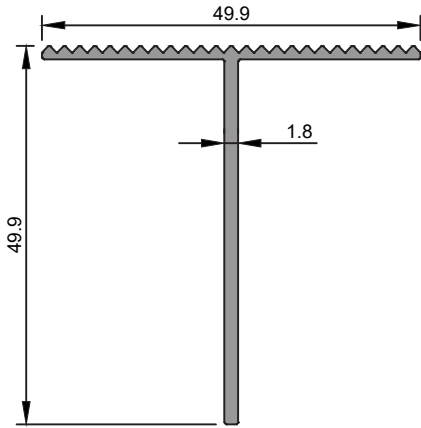

<b>1033</b>
0,421 kg/m

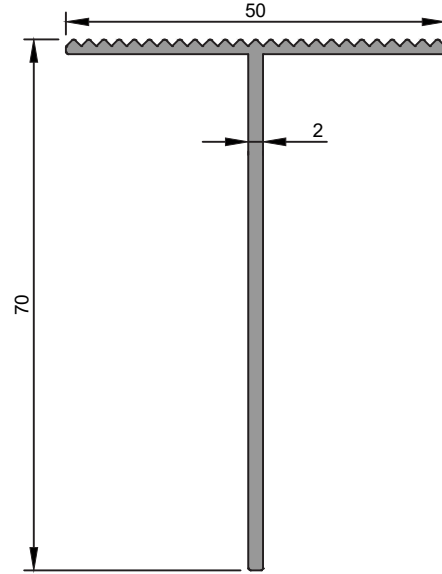

<b>1592</b>
0,569 kg/m

★ Yandaki profil birim ağırlıkları, bilgisayarda hesaplanmış teorik ağırlıklardır.

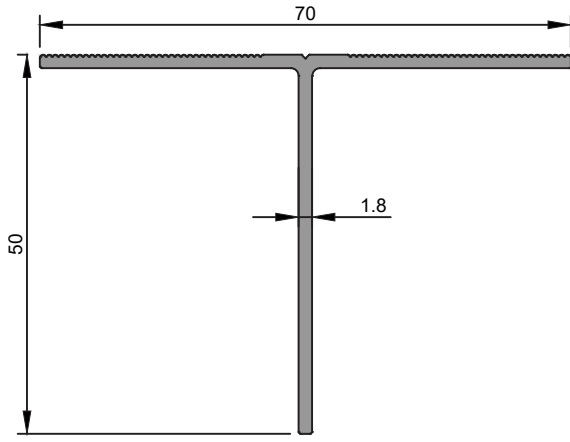

<b>1747</b>
0,558 kg/m

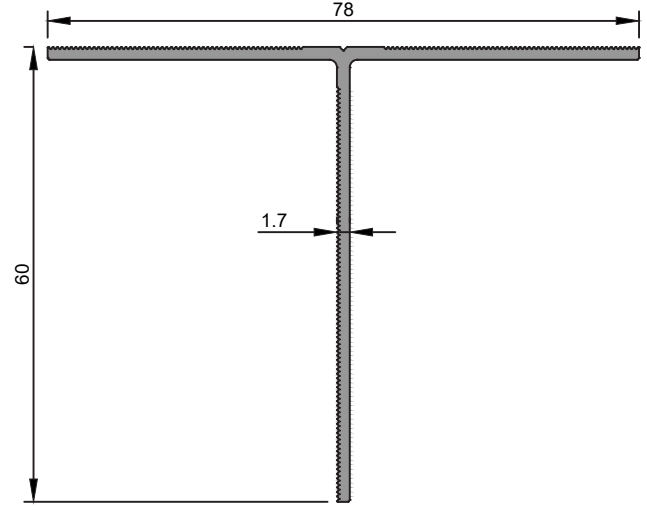

<b>1170</b>
0,578 kg/m

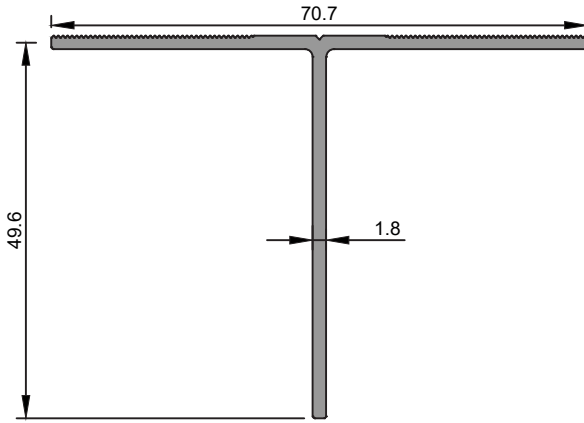

<b>1158</b>
0,560 kg/m

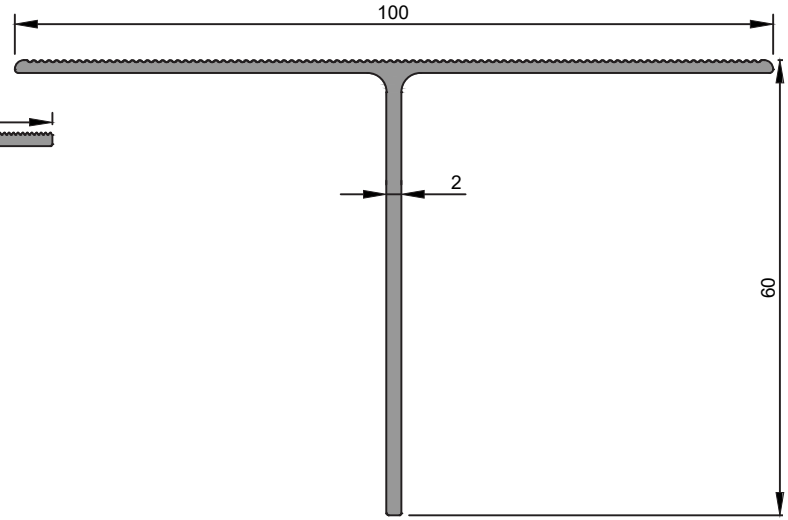

<b>1797</b>
0,742 kg/m



★ Yandaki profil birim ağırlıkları, bilgisayarla hesaplanmış teorik ağırlıklardır.

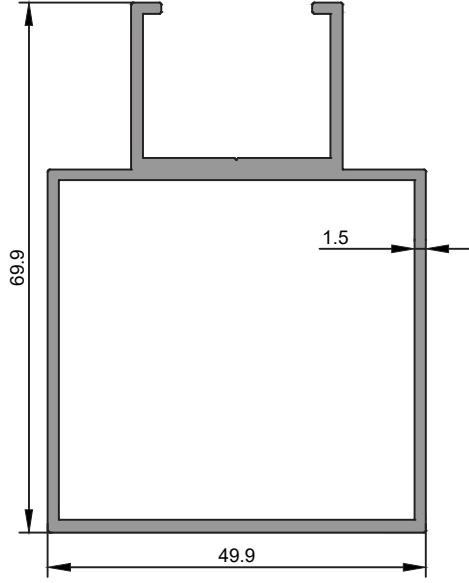

**1192**  
1,093 kg/m

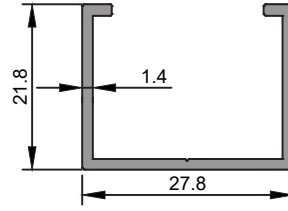

**1193**  
0,280 kg/m

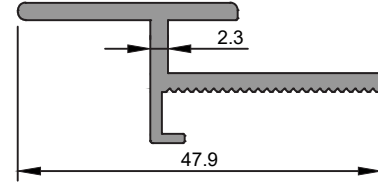

**1884**  
0,448 kg/m

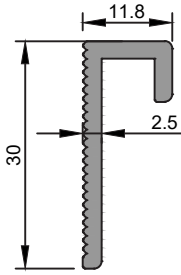

**1882**  
0,278 kg/m

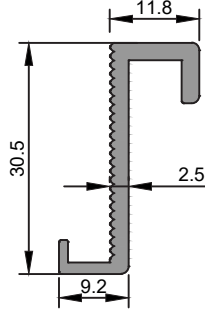

**1883**  
0,318 kg/m

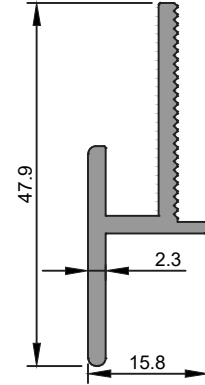

**1543**  
0,427 kg/m

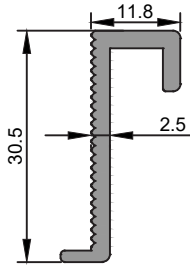

**1544**  
0,297 kg/m

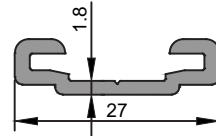

**1358**  
0,226 kg/m

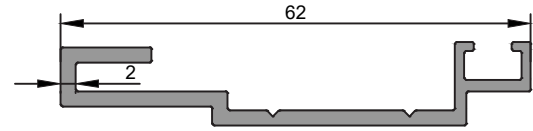

**1733**  
0,477 kg/m

★ Yandaki profil birim ağırlıkları, bilgisayarla hesaplanmış teorik ağırlıklardır.

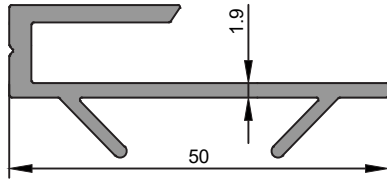
**1734**

0,553 kg/m

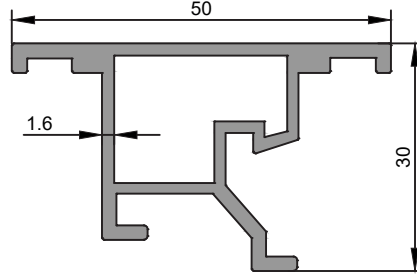
**1753**

0,700 kg/m

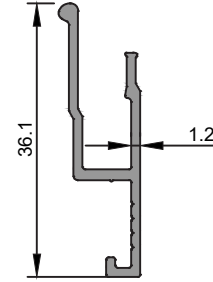
**1476**

0,220 kg/m

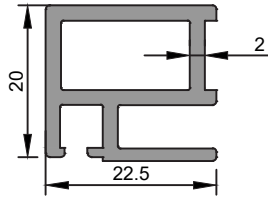
**1261**

1,329 kg/m

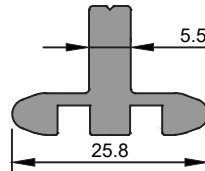
**1335**

0,433 kg/m

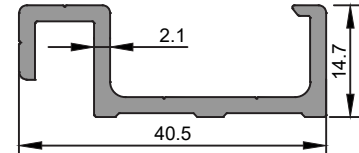
**1464**

0,435 kg/m

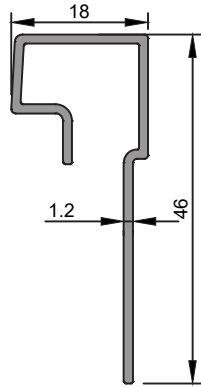
**1649**

0,278 kg/m

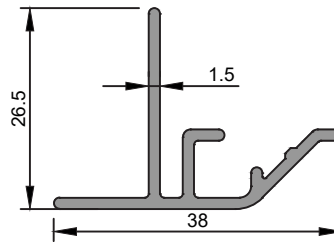

**1364**

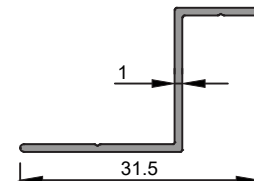
0,333 kg/m

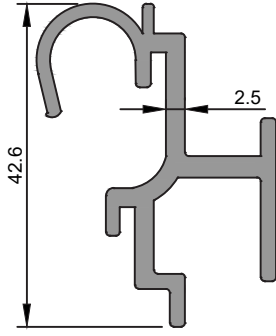

**1366**

0,133 kg/m

★ Yandaki profil birim ağırlıkları, bilgisayarda hesaplanmış teorik ağırlıklardır.

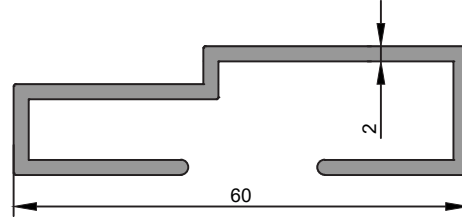

1754  
0,718 kg/m



1566  
0,696 kg/m

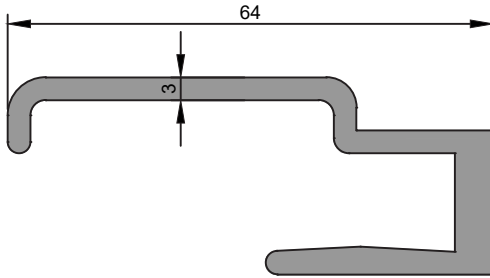

1565  
1,051 kg/m

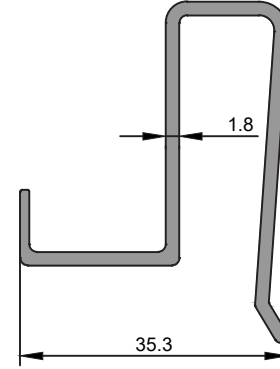

1316  
0,563 kg/m

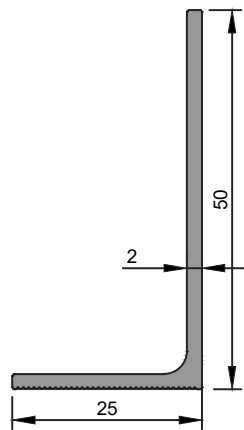

1748  
0,394 kg/m

★ Yandaki profil birim ağırlıkları, bilgisayarla hesaplanmış teorik ağırlıklardır.

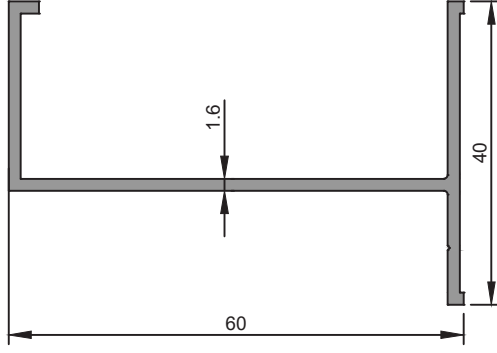

1692
0,540 kg/m

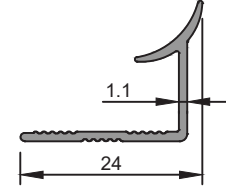

1682
0,139 kg/m

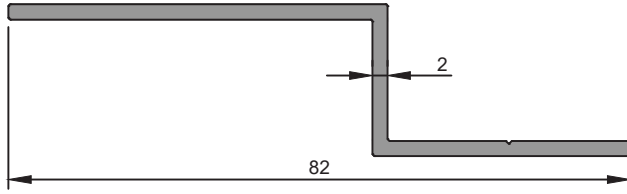

1355
0,541 kg/m

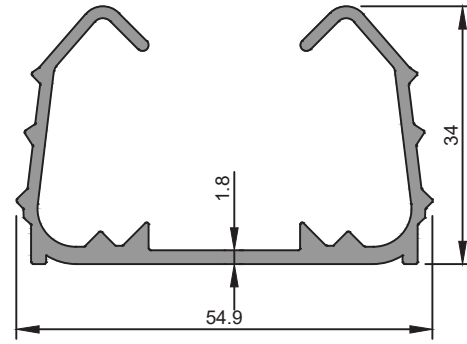

1354
0,751 kg/m

★ Yandaki profil birim ağırlıkları, bilgisayarda hesaplanmış teorik ağırlıklardır.

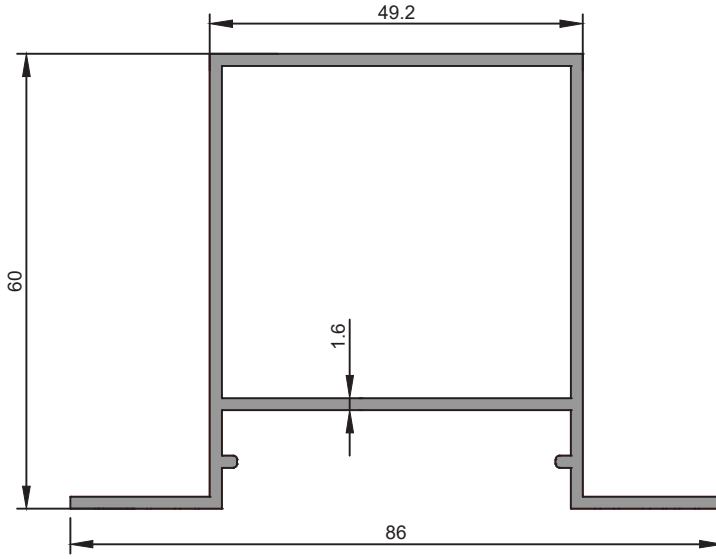

<b>2098</b>
1,095 kg/m

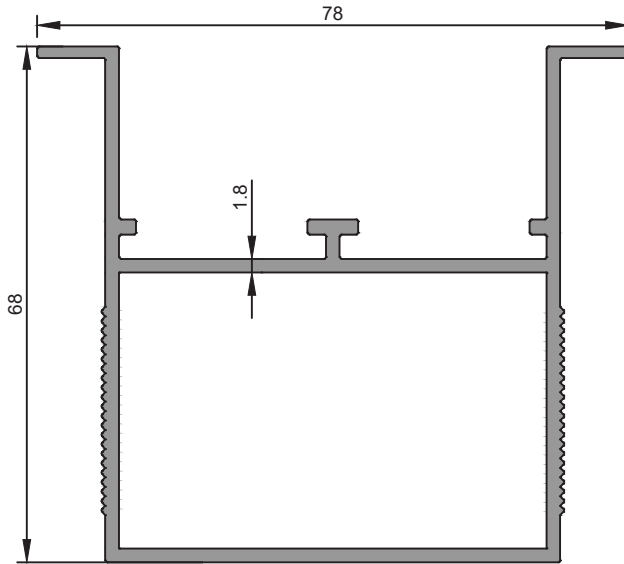

<b>1632</b>
1,407 kg/m

★ Yandaki profil birim ağırlıkları, bilgisayarla hesaplanmış teorik ağırlıklardır.

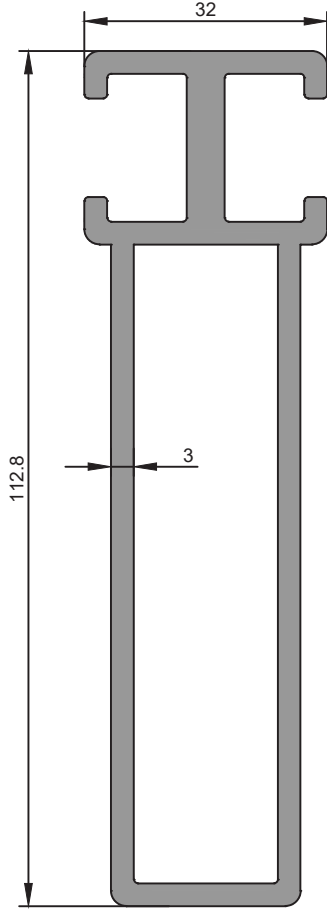

<b>1482</b>
1,449 kg/m

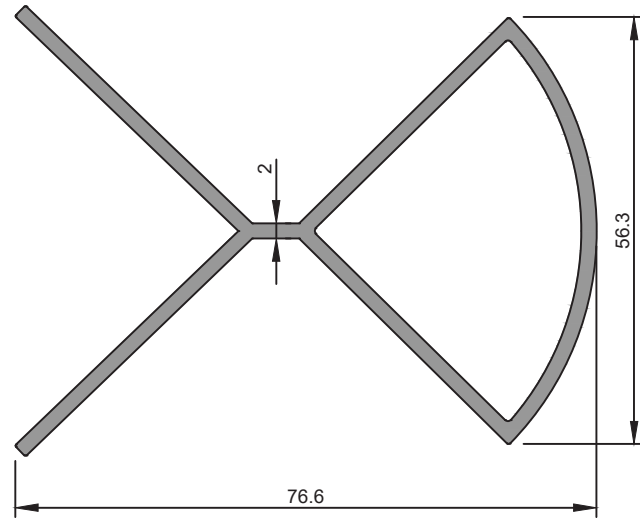

<b>1798</b>
1,215 kg/m

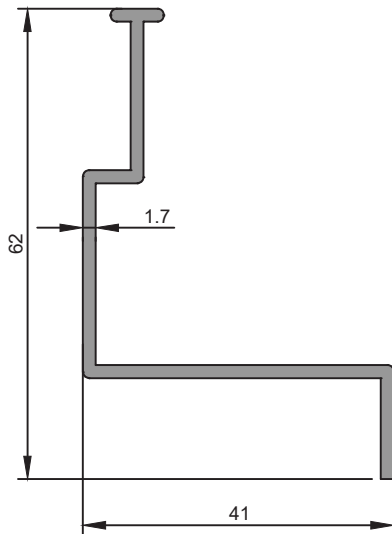

<b>1978</b>
0,517 kg/m

★ Yandaki profil birim ağırlıkları, bilgisayarda hesaplanmış teorik ağırlıklardır.

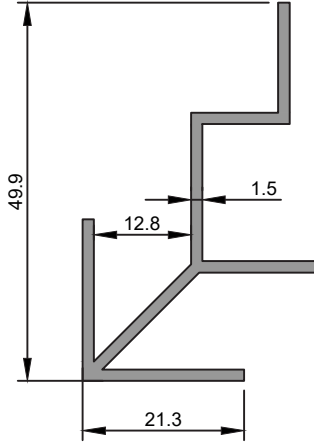
**3776**

0,494 kg/m

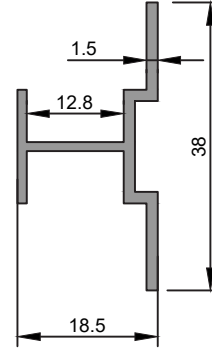
**3777**

0,269 kg/m

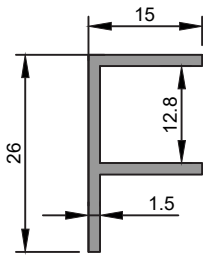

**3778**

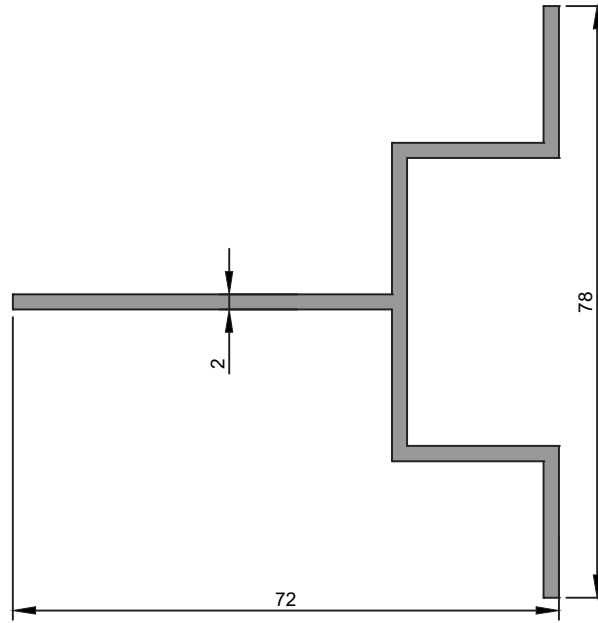
0,217 kg/m

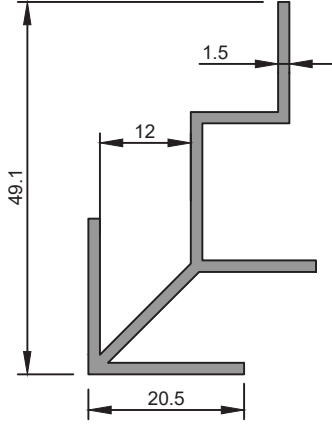

**3192**

0,910 kg/m

★ Yandaki profil birim ağırlıkları, bilgisayarda hesaplanmış teorik ağırlıklardır.

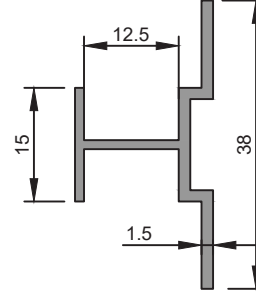

<b>3220</b>
0,484 kg/m



<b>3221</b>
0,268 kg/m

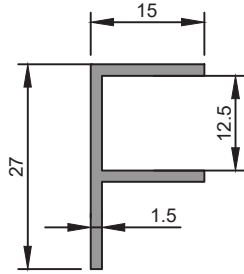

<b>3222</b>
0,220 kg/m



★ Yandaki profil birim ağırlıkları, bilgisayarda hesaplanmış teorik ağırlıklardır.

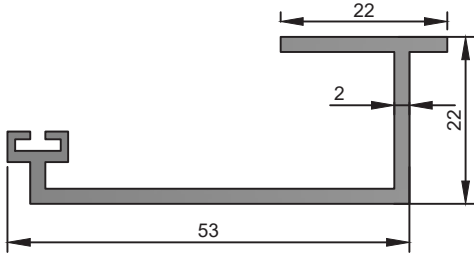

<b>3668</b>
0,563 kg/m

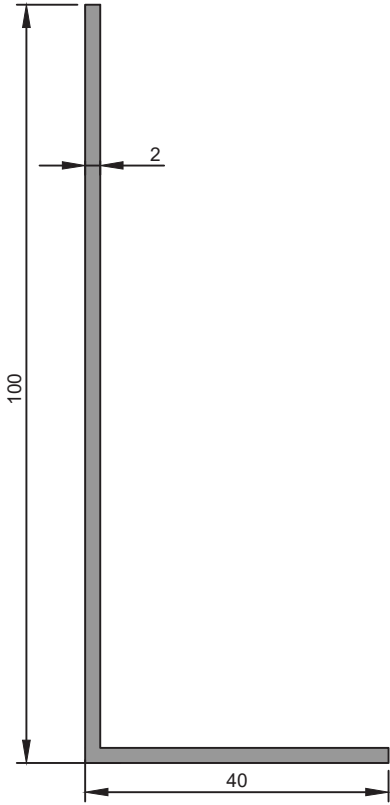

<b>3748</b>
0,748 kg/m

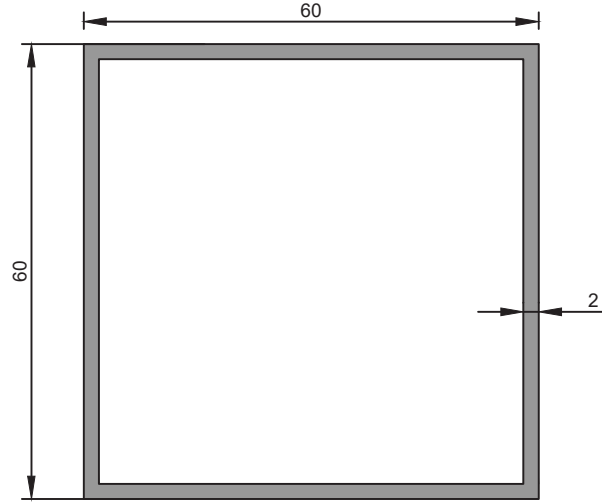

<b>3802</b>
1,257 kg/m

★ Yandaki profil birim ağırlıkları, bilgisayararda hesaplanmış teorik ağırlıklardır.

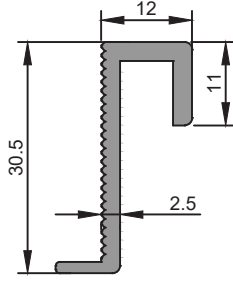

<b>3954</b>
0,334 kg/m

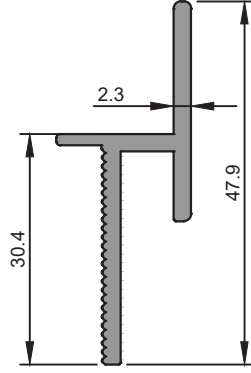

<b>3955</b>
0,436 kg/m

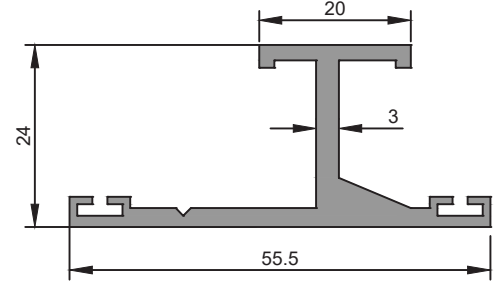

<b>3999</b>
0,708 kg/m

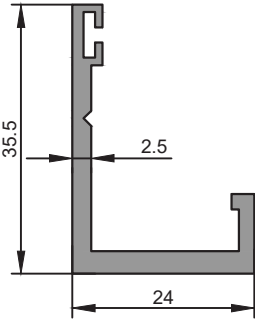

<b>4015</b>
0,461 kg/m

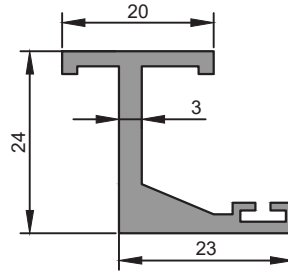

<b>4016</b>
0,488 kg/m

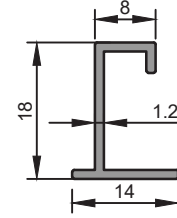

<b>4798</b>
0,131 kg/m

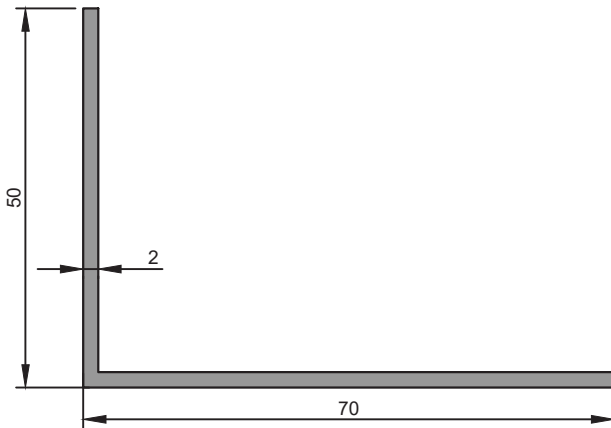

<b>4068</b>
0,640 kg/m

★ Yandaki profil birim ağırlıkları, bilgisayarda hesaplanmış teorik ağırlıklardır.

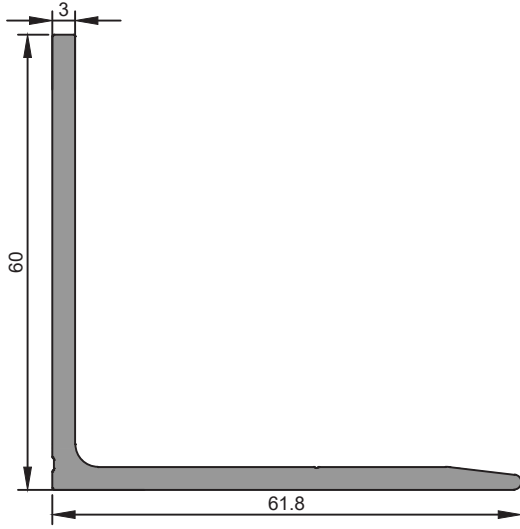

**2637**

0,954 kg/m

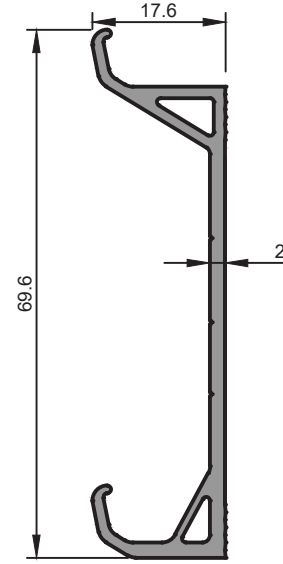

**2999**

0,594 kg/m

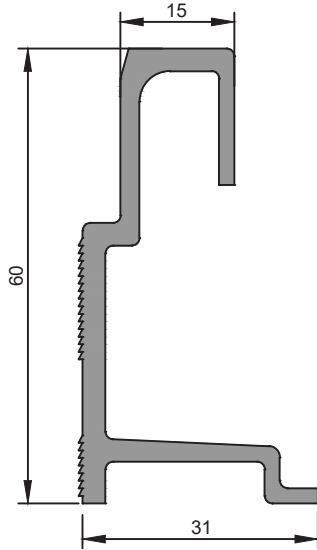

**2634**

0,909 kg/m

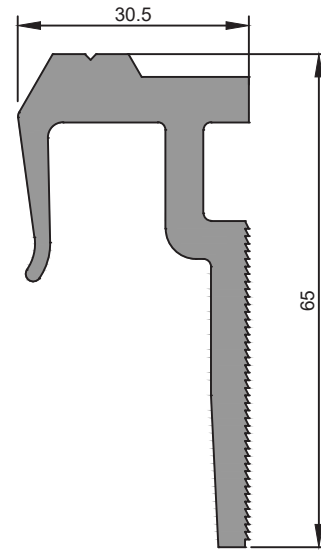

**2635**

1,500 kg/m

★ Yandaki profil birim ağırlıkları, bilgisayarda hesaplanmış teorik ağırlıklardır.

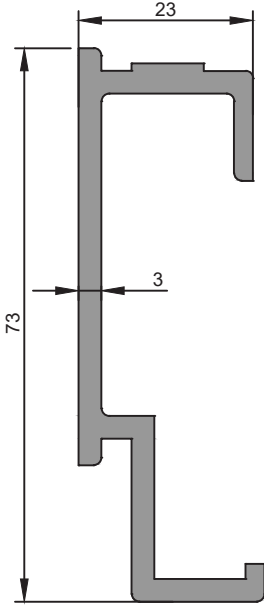

**2636**

1,074 kg/m

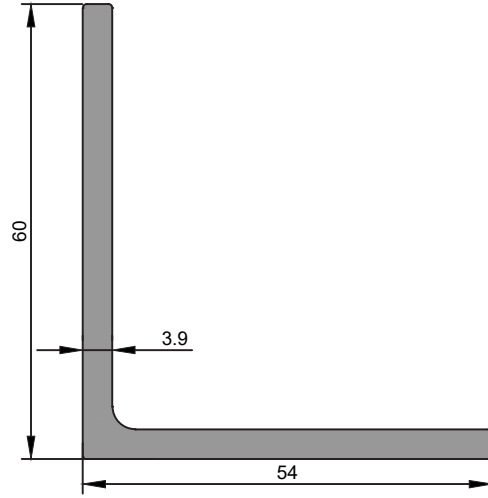

**1365**

1,168 kg/m

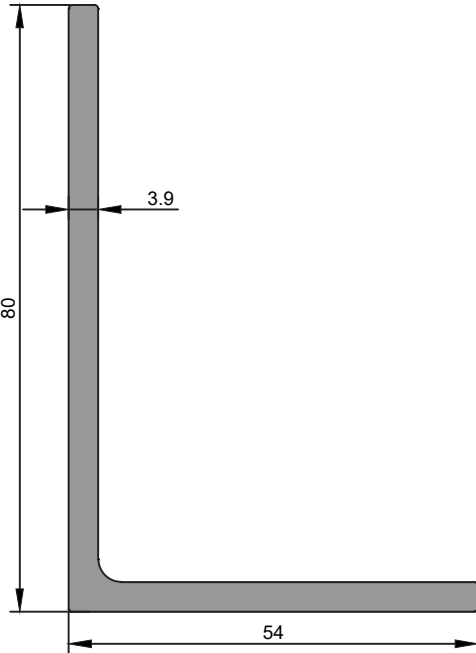

**1367**

1,379 kg/m

★ Yandaki profil birim ağırlıkları, bilgisayarda hesaplanmış teorik ağırlıklardır.

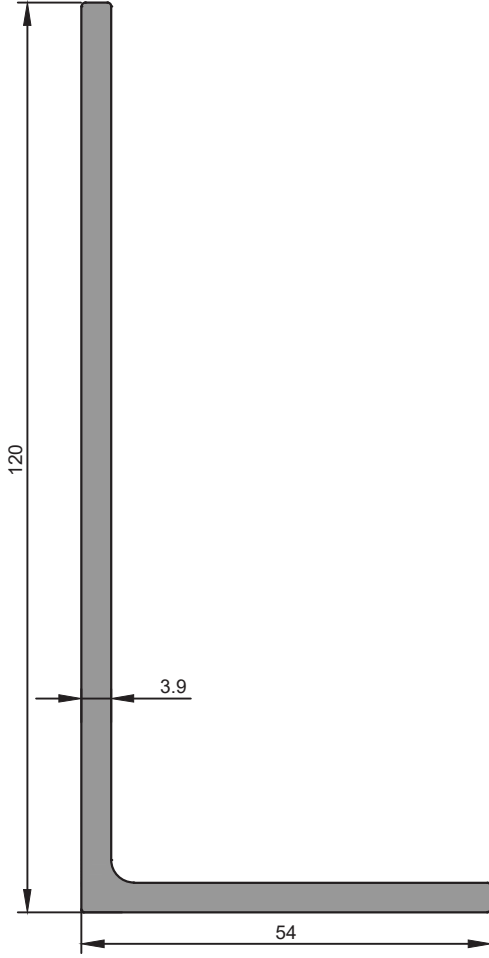

<b>1369</b>
1,802 kg/m

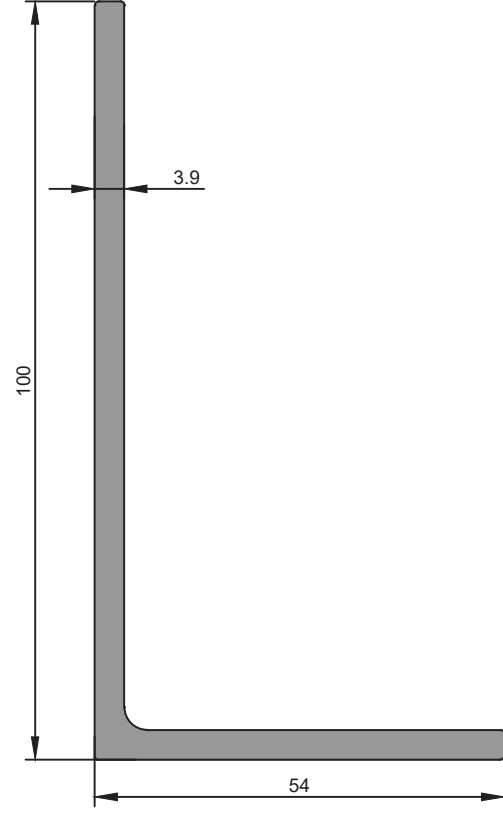

<b>1370</b>
1,590 kg/m

★ Yandaki profil birim ağırlıkları, bilgisayarla hesaplanmış teorik ağırlıklardır.

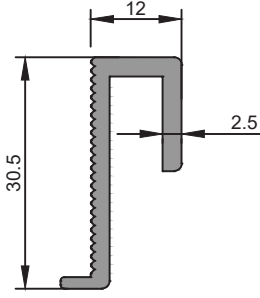

2900
0,353 kg/m

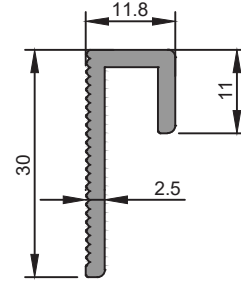

2901
0,297 kg/m

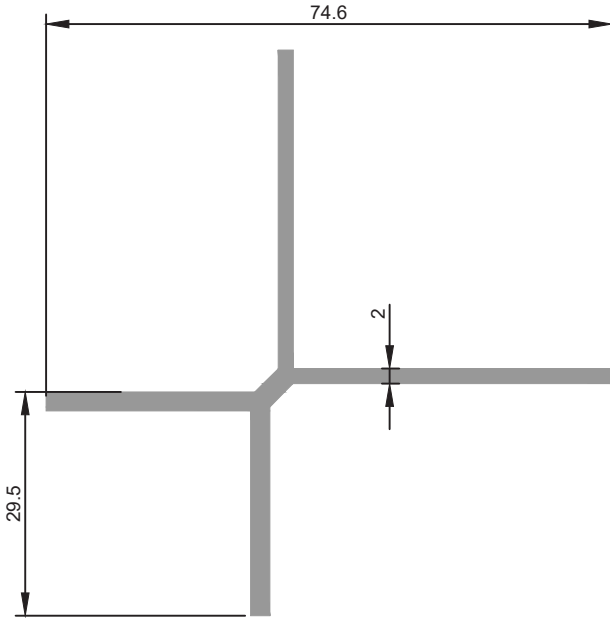

3025
0,871 kg/m

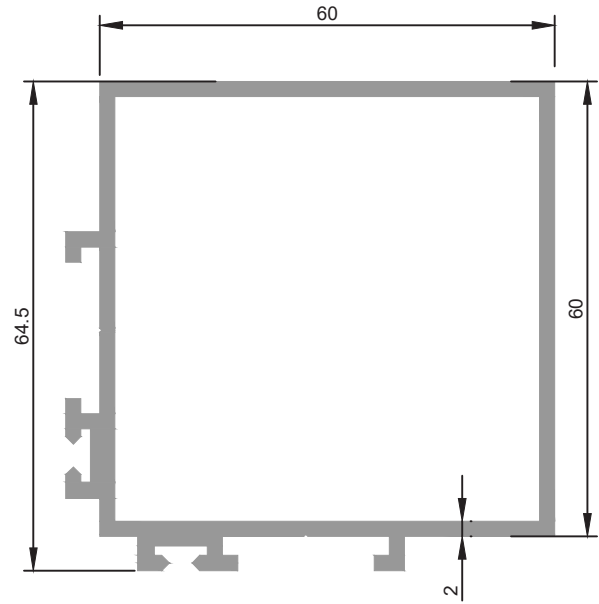

3026
1,531 kg/m

★ Yandaki profil birim ağırlıkları, bilgisayarda hesaplanmış teorik ağırlıklardır.

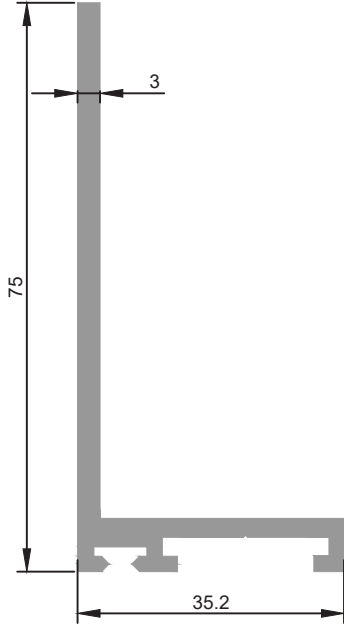
**3027**

0,928 kg/m

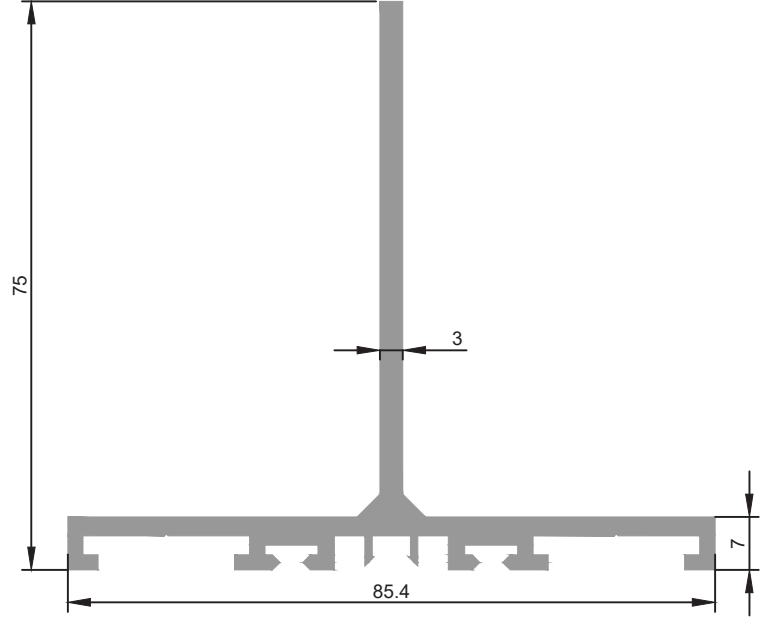
**3028**

1,448 kg/m







## PROFİL KATALOĐU







# TEMİZ ODA PROFİLLERİ

## COOLING ROOM PROFILES

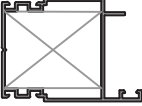
★ Profil Ağırlıkları Teorik Olup Teslim Anındaki Ağırlık Geçerlidir

★ *Weight of profiles are theoretical, net weight will valid at the time of delivery.*

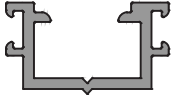
★ Yandaki profil birim ağırlıkları, bilgisayarda hesaplanmış teorik ağırlıklardır.

PROFİL KESİTİ	PROFİL KODU	PROFİL ADI	AĞIRLIK	ATALET MOMENTLERİ		SAYFA NO
				$J_x$ (cm <sup>4</sup> )	$J_y$ (cm <sup>4</sup> )	
	3486	Panel Kasa	0,945 kg/m	15,95	14,21	
	3485	Panel Kapı	1,197 kg/m	26,67	18,52	
	3487	Kapı Çıtası	0,257 kg/m	...	...	
	3489	Orta Kayıt Çıtası	0,538 kg/m	...	...	
	3294	Cam Arası Kapağı	0,127 kg/m	...	...	
	3297	Cam Arası Kapağı	0,382 kg/m	...	...	
	2916	Köşe Takozu	4,919 kg/m	...	...	

★ Yandaki profil birim ağırlıkları, bilgisayararda hesaplanmış teorik ağırlıklardır.

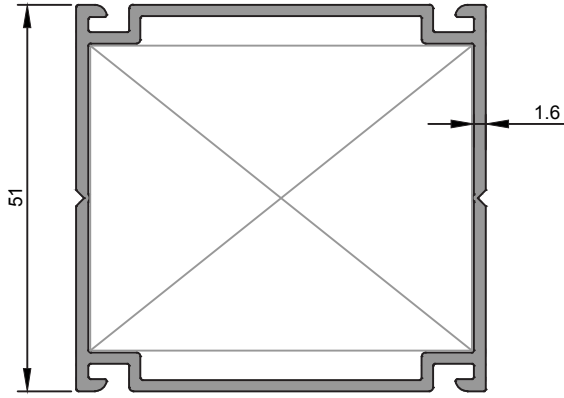

<b>3486</b>
Panel Kasa
0,945 kg/m
Jx=15,95 cm <sup>4</sup> Jy=14,21 cm <sup>4</sup>

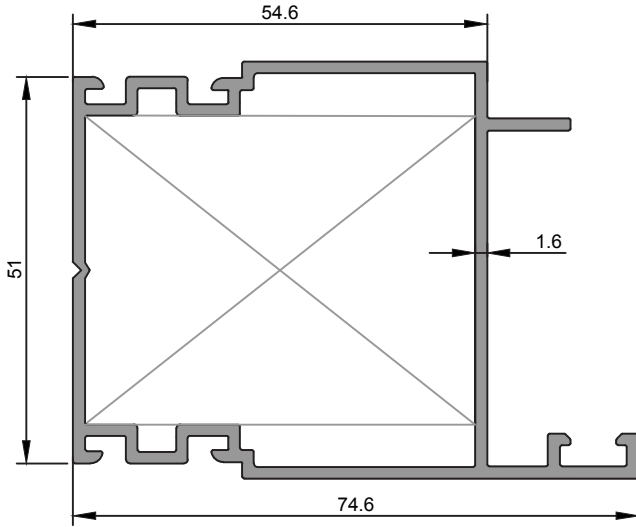

<b>3485</b>
Panel Kapı
1,197 kg/m
Jx=26,67 cm <sup>4</sup> Jy=18,52 cm <sup>4</sup>

★ Yandaki profil birim ağırlıkları, bilgisayarla hesaplanmış teorik ağırlıklardır.

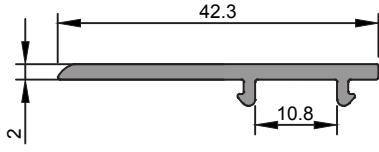

<b>3487</b>
Kapı Çıtası
0,257 kg/m

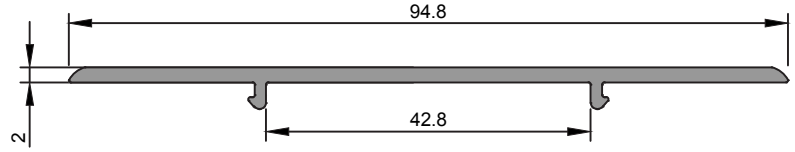

<b>3489</b>
Orta Kayıt Çıtası
0,538 kg/m

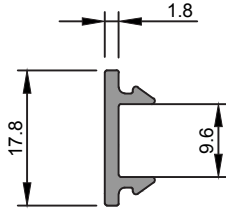

<b>3294</b>
Cam Arası Kapağı
0,127 kg/m

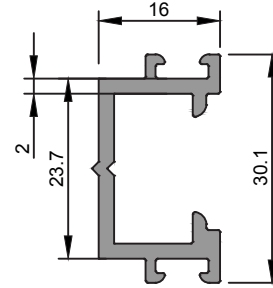

<b>3297</b>
Cam Arası Kapağı
0,382 kg/m

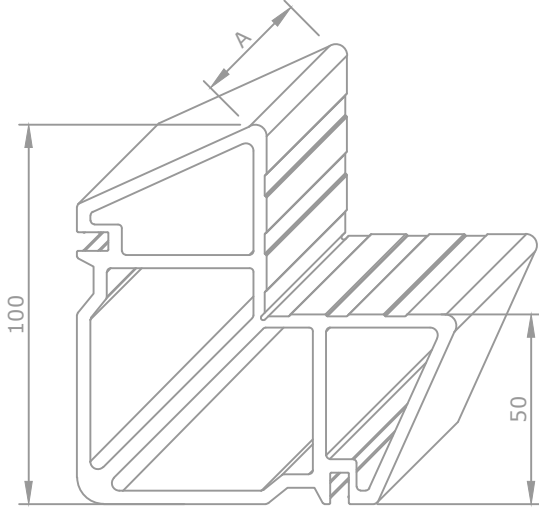
**KÖŞE TAKOZU KESİM ÖLÇÜLERİ****2916**

Köşe Takozu

4,919 kg/m

Aksesuar Kodu	Profil Kodu	Kesim Ölçüsü A(mm)
K2916 402	3485	40.2
K2916 402	3486	40.2

★ Yandaki profil birim ağırlıkları, bilgisayarla hesaplanmış teorik ağırlıklardır.

**DETAY-1**  
ÖLÇEK:1/1

★ Yandaki profil birim ağırlıkları, bilgisayarla hesaplanmış teorik ağırlıklardır.

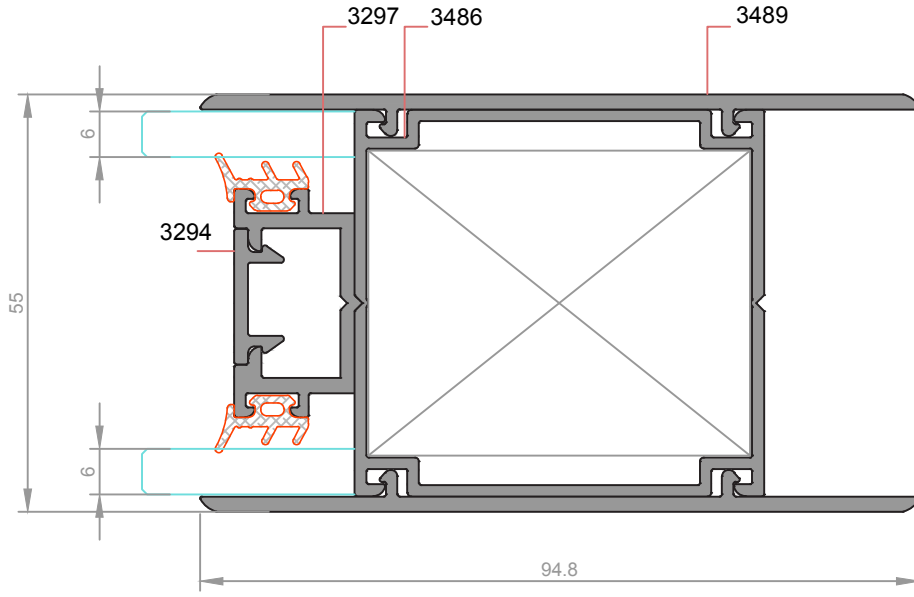









## PROFİL KATALOĐU









# VİTRİN PROFİLLERİ

## SHOWCASE PROFILE

★ Profil Ağırlıkları Teorik Olup Teslim Anındaki Ağırlık Geçerlidir

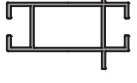
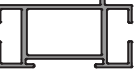
★ *Weight of profiles are theoretical, net weight will valid at the time of delivery.*

★ Yandaki profil birim ağırlıkları, bilgisayarda hesaplanmış teorik ağırlıklardır.

PROFİL KESİTİ	PROFİL KODU	PROFİL ADI	AĞIRLIK	ATALET MOMENTLERİ		SAYFA NO
				$J_x$ (cm <sup>4</sup> )	$J_y$ (cm <sup>4</sup> )	
	1399	...	0,540 kg/m	...	...	
	1143	...	0,665 kg/m	...	...	
	1061	...	0,572 kg/m	...	...	
	1052	...	0,727 kg/m	...	...	
	1246	...	0,727 kg/m	...	...	
	1802	...	0,768 kg/m	...	...	
	1803	...	0,740 kg/m	...	...	
	1100	...	0,655 kg/m	...	...	
	1051	...	0,606 kg/m	...	...	
	1101	...	0,935 kg/m	...	...	

★ Yandaki profil birim ağırlıkları, bilgisayarda hesaplanmış teorik ağırlıklardır.

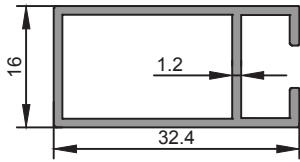

<b>1399</b>
0,540 kg/m

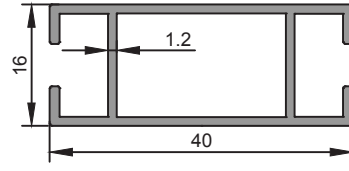

<b>1143</b>
0,665 kg/m

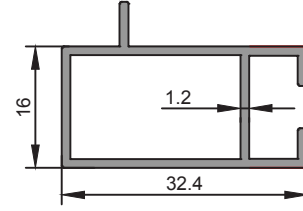

<b>1061</b>
0,572 kg/m

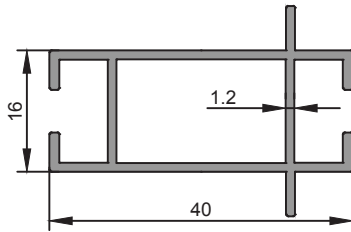

<b>1052</b>
0,727 kg/m

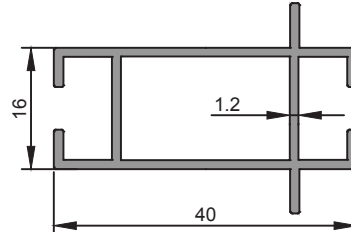

<b>1246</b>
0,727 kg/m

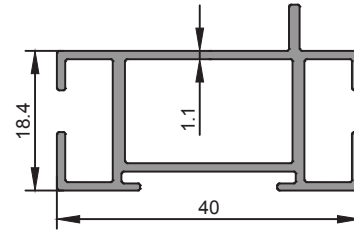

<b>1802</b>
0,768kg/m

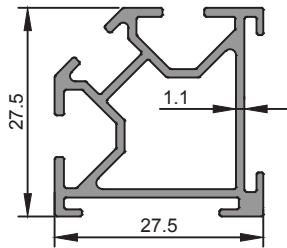

<b>1803</b>
0,740 kg/m

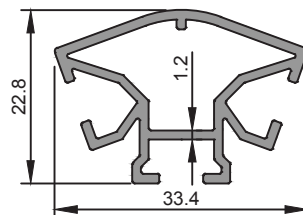

<b>1100</b>
0,655 kg/m

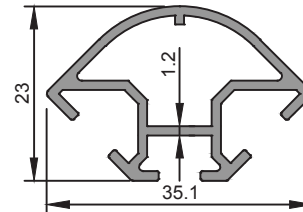

<b>1051</b>
0,606 kg/m

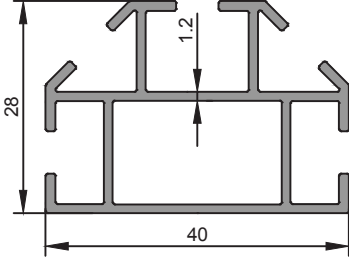

1101

0,935 kg/m

★ Yandaki profil birim ağırlıkları, bilgisayarla hesaplanmış teorik ağırlıklardır.



## PROFİL KATALOĐU







# GÜNEŐ KIRICI PROFİLLER

## SUNBREAKER PROFILES

★ Profil Ađırlıkları Teorik Olup Teslim Anındaki Ađırlık Geçerlidir

★ *Weight of profiles are theoretical, net weight will valid at the time of delivery.*

★ Yandaki profil birim ağırlıkları, bilgisayarda hesaplanmış teorik ağırlıklardır.

PROFİL KESİTİ	PROFİL KODU	PROFİL ADI	AĞIRLIK	ATALET MOMENTLERİ		SAYFA NO
				$J_x$ (cm <sup>4</sup> )	$J_y$ (cm <sup>4</sup> )	
	1895	Güneş Kırıcı Profili	1,290 kg/m	49,76	4,67	
	1896	Güneş Kırıcı Profili	1,047 kg/m	47,02	1,50	
	3283	Güneş Kırıcı Lameli Profili	0,618 kg/m	33,33	0,22	
	3282	Güneş Kırıcı Dikme Profili	1,327 kg/m	48,91	11,60	
	2255	Güneş Kırıcı Profili	0,870 kg/m	29,14	0,65	
	2256	Menfez Kasa Profili	0,535 kg/m	8,10	2,16	
	1456	40'lık Menfez Lameli Profili	0,385 kg/m	...	...	

★ Yandaki profil birim ağırlıkları, bilgisayarda hesaplanmış teorik ağırlıklardır.

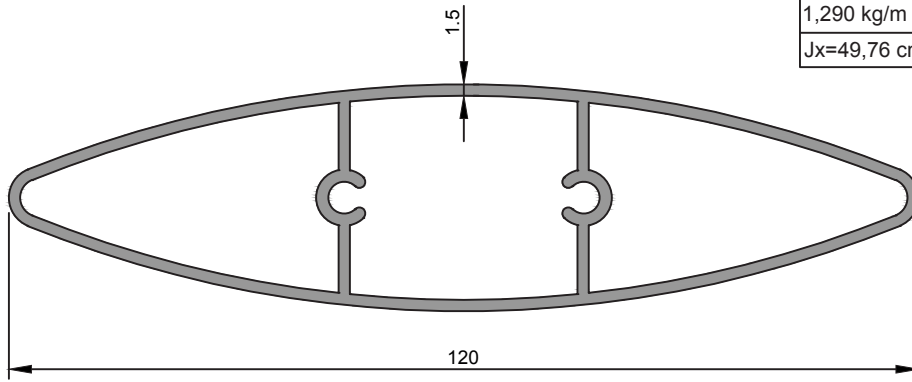

<b>1895</b>
Güneş Kırıcı Profili
1,290 kg/m
$Jx=49,76 \text{ cm}^4$ $Jy=4,67 \text{ cm}^4$

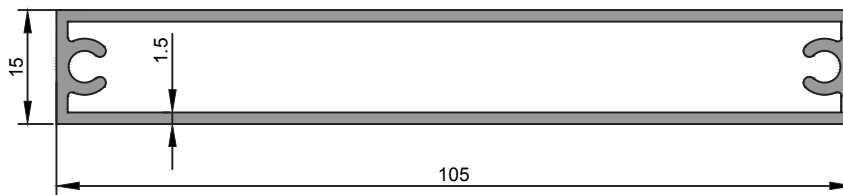

<b>1896</b>
Güneş Kırıcı Profili
1,047 kg/m
$Jx=47,02 \text{ cm}^4$ $Jy=1,50 \text{ cm}^4$

★ Yandaki profil birim ağırlıkları, bilgisayarla hesaplanmış teorik ağırlıklardır.

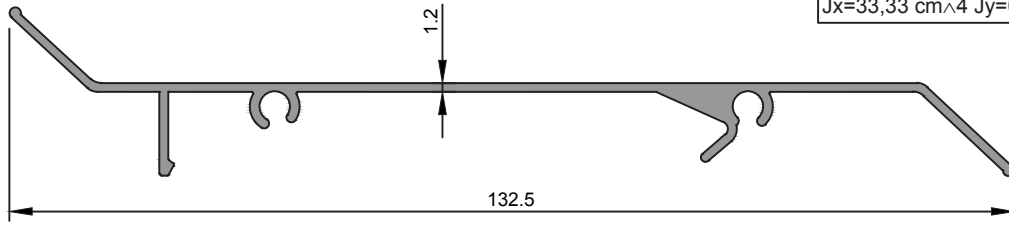

<b>3283</b>
Güneş Kırıcı Lameli Profili
0,618 kg/m
$J_x=33,33 \text{ cm}^4$ $J_y=0,22 \text{ cm}^4$

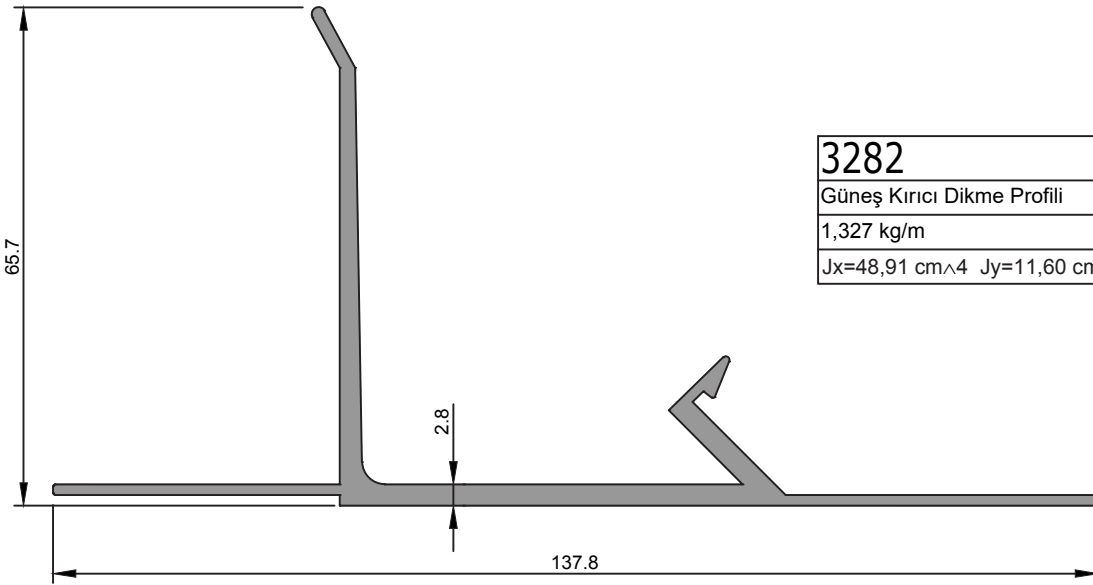

<b>3282</b>
Güneş Kırıcı Dikme Profili
1,327 kg/m
$J_x=48,91 \text{ cm}^4$ $J_y=11,60 \text{ cm}^4$



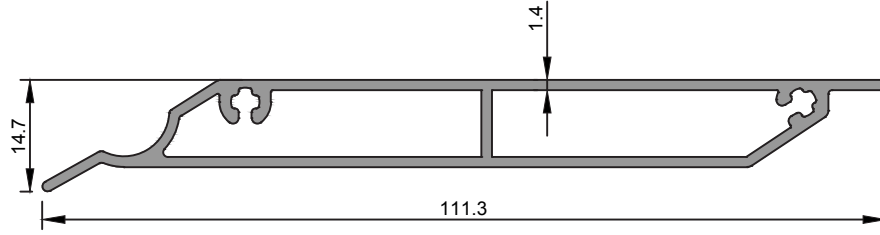

<b>2255</b>
Güneş Kırıcı Profili
0,870 kg/m
$J_x=29,14 \text{ cm}^4$ $J_y=0,65 \text{ cm}^4$

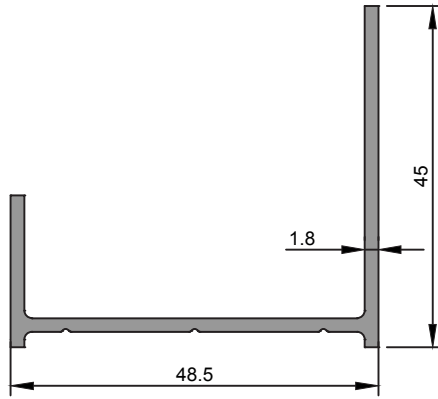

<b>2256</b>
Menfez Kasa Profili
0,535 kg/m
$J_x=8,10 \text{ cm}^4$ $J_y=2,16 \text{ cm}^4$

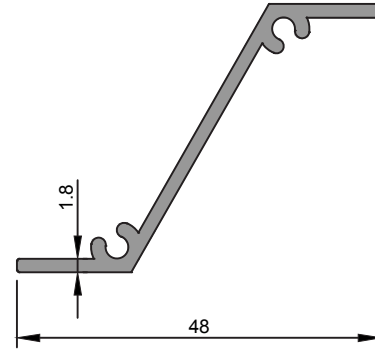

<b>1456</b>
40'lık Menfez Lameli Profili
0,385 kg/m

★ Yandaki profil birim ağırlıkları, bilgisayarla hesaplanmış teorik ağırlıklardır.





## PROFİL KATALOĐU















# ZEMİN PROFİLLER

## FLOORING PROFILE













★ Profil Ağırlıkları Teorik Olup Teslim Anındaki Ağırlık Geçerlidir

★ *Weight of profiles are theoretical, net weight will valid at the time of delivery.*



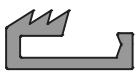







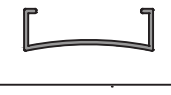
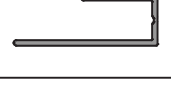

★ Yandaki profil birim ağırlıkları, bilgisayarda hesaplanmış teorik ağırlıklardır.

PROFİL KESİTİ	PROFİL KODU	PROFİL ADI	AĞIRLIK	ATALET MOMENTLERİ		SAYFA NO
				$J_x$ (cm <sup>4</sup> )	$J_y$ (cm <sup>4</sup> )	
	1822	...	0,158 kg/m	...	...	
	1253	...	0,116 kg/m	...	...	
	1752	...	0,126 kg/m	...	...	
	1254	...	0,64 kg/m	...	...	
	1572	...	1,92 kg/m	...	...	
	1774	...	0,96 kg/m	...	...	
	1746	...	0,99 kg/m	...	...	
	1031	...	0,133 kg/m	...	...	
	1795	...	0,87 kg/m	...	...	
	1475	...	0,183 kg/m	...	...	
	1295	...	0,151kg/m	...	...	
	2751	...	0,196 kg/m	...	...	
	1574	...	0,101 kg/m	...	...	
	1681	...	0,75 kg/m	...	...	



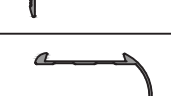

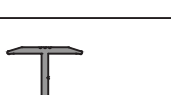
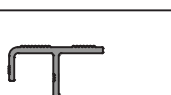





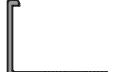

★ Yandaki profil birim ağırlıkları, bilgisayarda hesaplanmış teorik ağırlıklardır.

PROFİL KESİTİ	PROFİL KODU	PROFİL ADI	AĞIRLIK	ATALET MOMENTLERİ		SAYFA NO
				$J_x$ (cm <sup>4</sup> )	$J_y$ (cm <sup>4</sup> )	
	1773	...	0,97 kg/m	...	...	
	1781	...	0,110 kg/m	...	...	
	1780	...	0,144 kg/m	...	...	
	1775	...	0,141 kg/m	...	...	
	1575	...	0,105 kg/m	...	...	
	1571	...	0,81 kg/m	...	...	
	1577	...	0,57 kg/m	...	...	
	1862	...	0,252 kg/m	...	...	
	2082	...	0,177 kg/m	...	...	
	1272	...	0,322 kg/m	...	...	
	1573	...	0,108 kg/m	...	...	
	1700	...	0,140 kg/m	...	...	
	1810	...	0,155 kg/m	...	...	
	1268	...	0,101 kg/m	...	...	





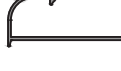









★ Yandaki profil birim ağırlıkları, bilgisayarda hesaplanmış teorik ağırlıklardır.

PROFİL KESİTİ	PROFİL KODU	PROFİL ADI	AĞIRLIK	ATALET MOMENTLERİ		SAYFA NO
				$J_x$ (cm <sup>4</sup> )	$J_y$ (cm <sup>4</sup> )	
	2051	...	0,216 kg/m	...	...	
	1784	...	0,130 kg/m	...	...	
	1387	...	0,137 kg/m	...	...	
	1019	...	0,162 kg/m	...	...	
	1568	...	0,85 kg/m	...	...	
	1861	...	0,250 kg/m	...	...	
	1652	...	0,168 kg/m	...	...	
	1390	...	0,424 kg/m	...	...	
	1389	...	0,225 kg/m	...	...	
	2083	...	0,232 kg/m	...	...	
	1691	...	0,272 kg/m	...	...	
	2357	...	0,341 kg/m	...	...	
	2358	...	0,163 kg/m	...	...	
	2241	...	0,226 kg/m	...	...	

★ Yandaki profil birim ağırlıkları, bilgisayarda hesaplanmış teorik ağırlıklardır.

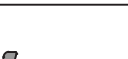
PROFİL KESİTİ	PROFİL KODU	PROFİL ADI	AĞIRLIK	ATALET MOMENTLERİ		SAYFA NO
				$J_x$ (cm <sup>4</sup> )	$J_y$ (cm <sup>4</sup> )	
	2353	...	0,98 kg/m	...	...	
	2354	...	0,111 kg/m	...	...	
	2828	...	0,146 kg/m	...	...	
	2781	...	0,282 kg/m	...	...	
	2352	...	0,103 kg/m	...	...	
	2752	...	0,148 kg/m	...	...	
	1142	...	0,128 kg/m	...	...	
	1683	...	0,118 kg/m	...	...	
	1257	...	0,123 kg/m	...	...	
	1730	...	0,113 kg/m	...	...	
	1074	...	0,83 kg/m	...	...	
	1823	...	0,121 kg/m	...	...	
	1552	...	0,103 kg/m	...	...	
	1397	...	0,118 kg/m	...	...	

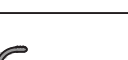
★ Yandaki profil birim ağırlıkları, bilgisayarda hesaplanmış teorik ağırlıklardır.

PROFİL KESİTİ	PROFİL KODU	PROFİL ADI	AĞIRLIK	ATALET MOMENTLERİ		SAYFA NO
				$J_x$ (cm <sup>4</sup> )	$J_y$ (cm <sup>4</sup> )	
	1757	...	0,101 kg/m	...	...	
	1917	...	0,144 kg/m	...	...	
	1651	...	0,156 kg/m	...	...	
	1660	...	0,155 kg/m	...	...	
	1602	...	0,158 kg/m	...	...	
	1570	...	0,138 kg/m	...	...	
	1576	...	0,134 kg/m	...	...	
	1777	...	0,116 kg/m	...	...	
	1793	...	0,104 kg/m	...	...	
	1783	...	0,108 kg/m	...	...	
	1782	...	0,101 kg/m	...	...	
	1616	...	0,142 kg/m	...	...	
	1274	...	0,138 kg/m	...	...	
	1032	...	0,162 kg/m	...	...	





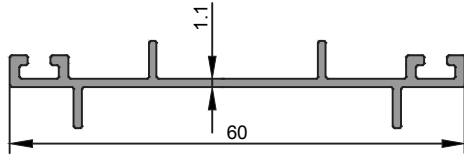

<b>1755</b>
0,290 kg/m

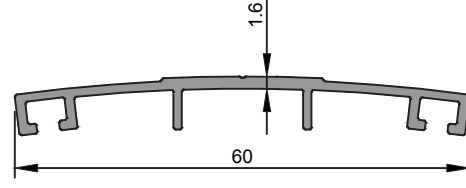

<b>1756</b>
0,319 kg/m

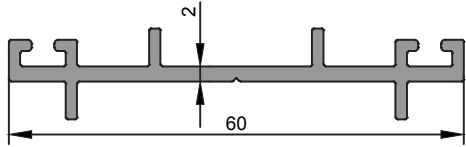

<b>1121</b>
0,486 kg/m

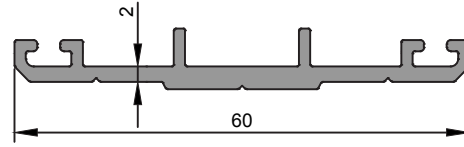

<b>1222</b>
0,490 kg/m

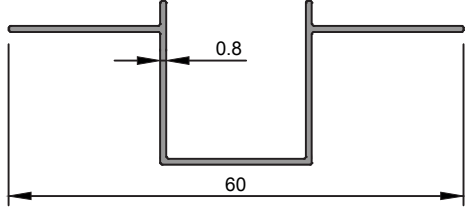

<b>1831</b>
0,220 kg/m

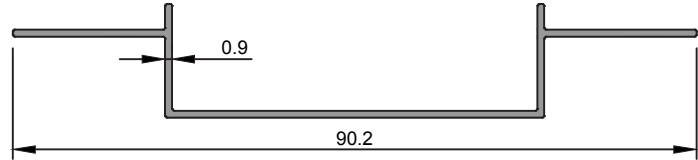

<b>1834</b>
0,288 kg/m

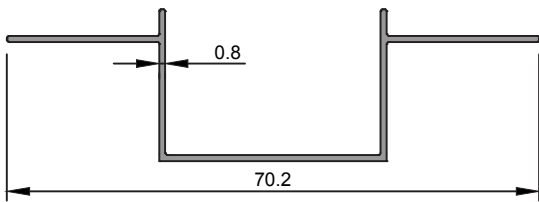

<b>1832</b>
0,235 kg/m

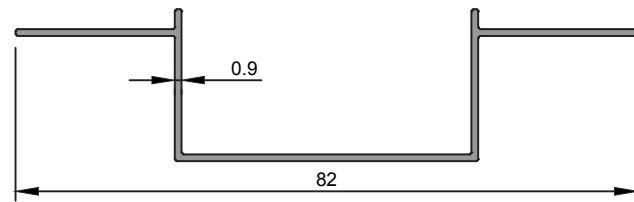

<b>1833</b>
0,293 kg/m

★ Yandaki profil birim ağırlıkları, bilgisayarla hesaplanmış teorik ağırlıklardır.

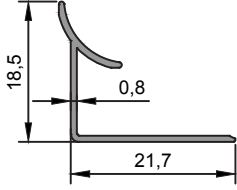
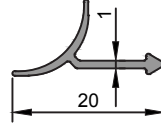
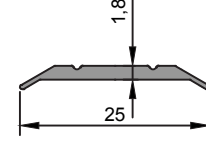
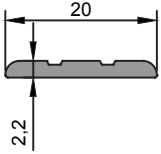
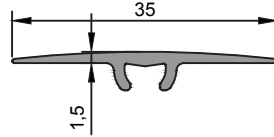
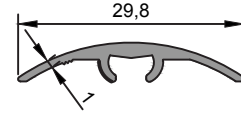
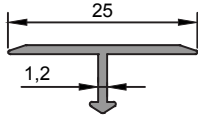
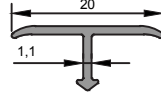
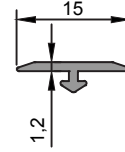
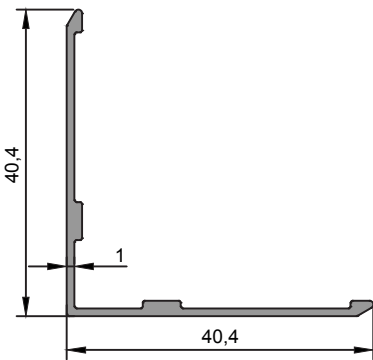
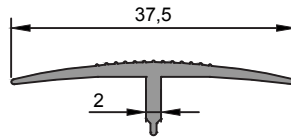
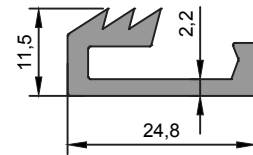
**1574**  
 0,101 kg/m

**1681**  
 0,75 kg/m

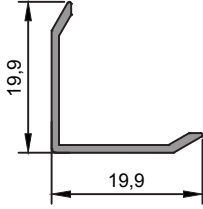
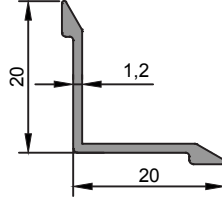
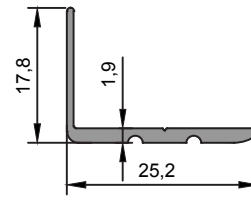
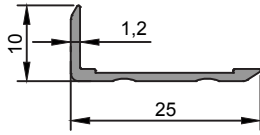
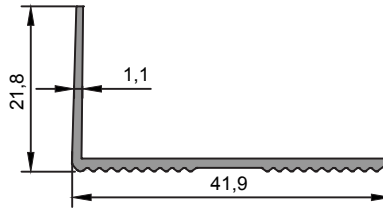
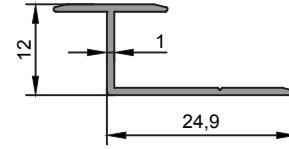
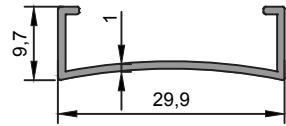
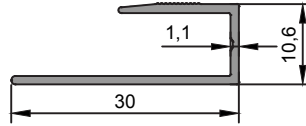
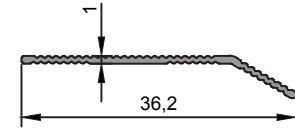
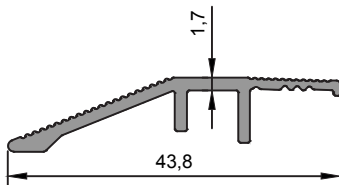
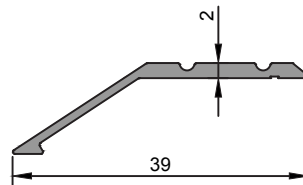
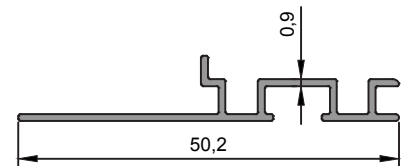
**1773**  
 0,97 kg/m

**1781**  
 0,110 kg/m

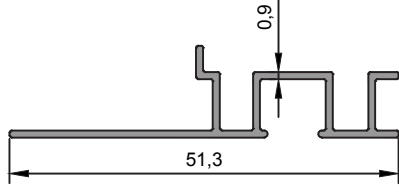
**1780**  
 0,144 kg/m

**1775**  
 0,141 kg/m

**1575**  
 0,105 kg/m

**1571**  
 0,81 kg/m

**1577**  
 0,57 kg/m

**1862**  
 0,252 kg/m

**2082**  
 0,177 kg/m

**1272**  
 0,322 kg/m

★ Yandaki profil birim ağırlıkları, bilgisayarda hesaplanmış teorik ağırlıklardır.

**1573**  
 0,108 kg/m

**1700**  
 0,140 kg/m

**1810**  
 0,155 kg/m

**1268**  
 0,101 kg/m

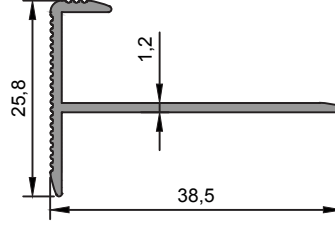
**2051**  
 0,216 kg/m

**1784**  
 0,130 kg/m

**1387**  
 0,137 kg/m

**1019**  
 0,162 kg/m

**1568**  
 0,85 kg/m

**1861**  
 0,250 kg/m

**1652**  
 0,168 kg/m

**1390**  
 0,424 kg/m

★ Yandaki profil birim ağırlıkları, bilgisayarda hesaplanmış teorik ağırlıklardır.

**1389**

0,225 kg/m

**2083**

0,232 kg/m

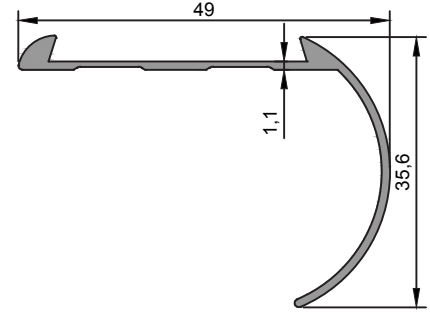
**1691**

0,272 kg/m

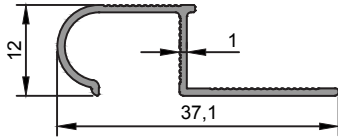
**2357**

0,341 kg/m

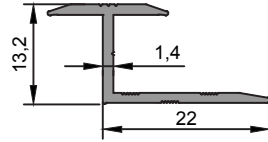
**2358**

0,163 kg/m

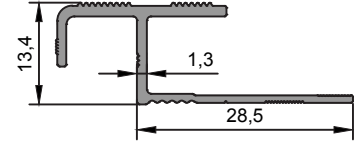
**2241**

0,226 kg/m

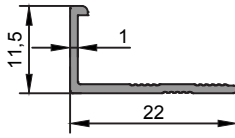
**2353**

0,98 kg/m

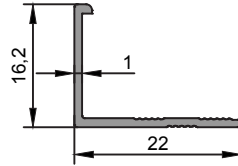
**2354**

0,111 kg/m

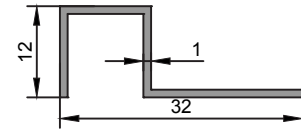
**2828**

0,146 kg/m

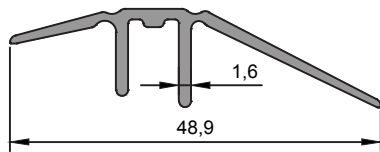
**2781**

0,282 kg/m

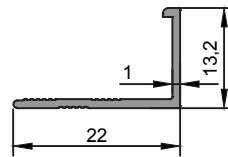

**2352**

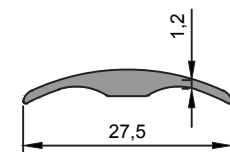
0,103 kg/m

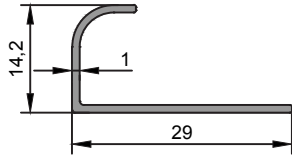

**2752**

0,148 kg/m

★ Yandaki profil birim ağırlıkları, bilgisayarda hesaplanmış teorik ağırlıklardır.

**1142**

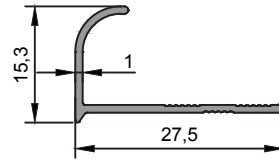
0,128 kg/m

**1683**

0,118 kg/m

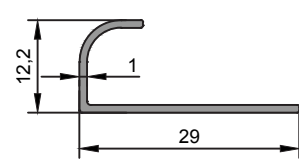
**1257**

0,123 kg/m

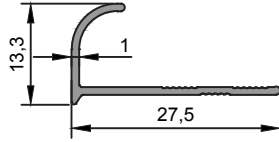
**1730**

0,113 kg/m

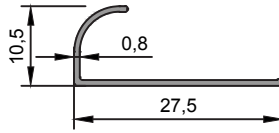
**1074**

0,83 kg/m

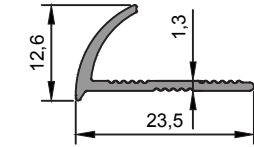
**1823**

0,121 kg/m

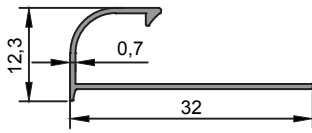
**1552**

0,103 kg/m

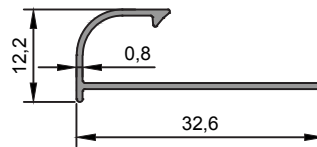
**1397**

0,118 kg/m

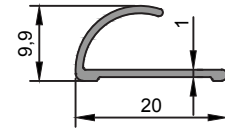
**1757**

0,101 kg/m

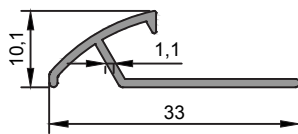
**1617**

0,144 kg/m

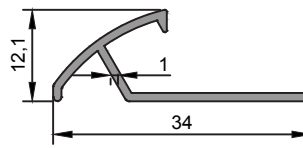
**1651**

0,156 kg/m

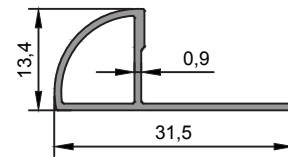
**1660**

0,155 kg/m

★ Yandaki profil birim ağırlıkları, bilgisayarda hesaplanmış teorik ağırlıklardır.

★ Yandaki profil birim ağırlıkları, bilgisayarda hesaplanmış teorik ağırlıklardır.

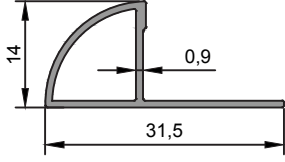
**1602**

0,158 kg/m

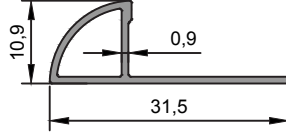
**1570**

0,138 kg/m

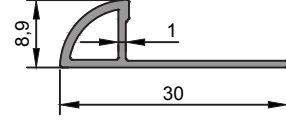
**1576**

0,134 kg/m

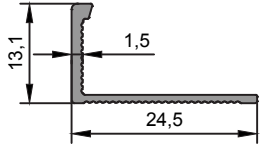
**1777**

0,116 kg/m

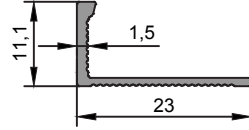
**1793**

0,104 kg/m

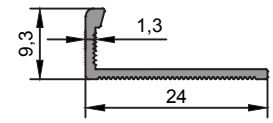
**1783**

0,108 kg/m

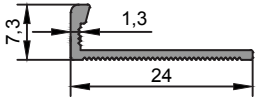
**1782**

0,101 kg/m

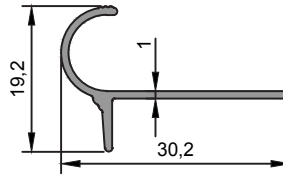
**1616**

0,142 kg/m

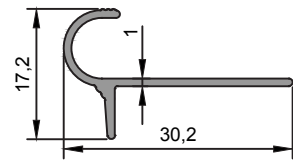
**1274**

0,138 kg/m

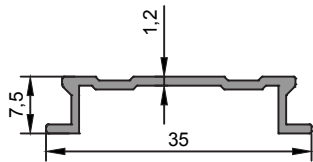
**1032**

0,162 kg/m

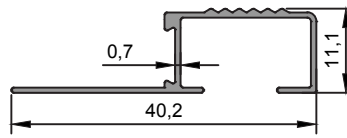
**1380**

0,146 kg/m

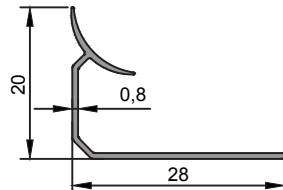
**1229**

0,106 kg/m

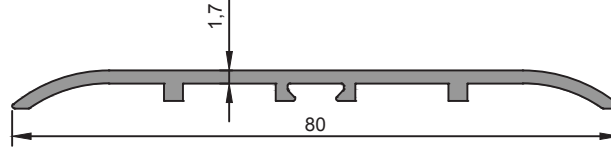

<b>1669</b>
0,424 kg/m

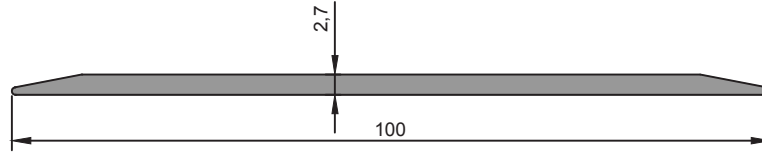

<b>1320</b>
0,686 kg/m

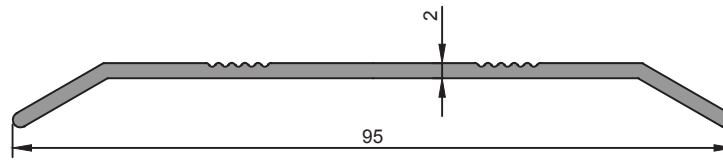

<b>1792</b>
0,519 kg/m

★ Yandaki profil birim ağırlıkları, bilgisayarda hesaplanmış teorik ağırlıklardır.





## PROFİL KATALOĐU













# PANJUR PROFİLLERİ

## SHUTTER PROFILES

★ Profil Ağırlıkları Teorik Olup Teslim Anındaki Ağırlık Geçerlidir

★ *Weight of profiles are theoretical, net weight will valid at the time of delivery.*

★ Yandaki profil birim ağırlıkları, bilgisayarda hesaplanmış teorik ağırlıklardır.

PROFİL KESİTİ	PROFİL KODU	PROFİL ADI	AĞIRLIK	ATALET MOMENTLERİ		SAYFA NO
				$J_x$ (cm <sup>4</sup> )	$J_y$ (cm <sup>4</sup> )	
	1324	Panjur Profili	1,296 kg/m	...	...	
	1686	Panjur Profili	1,133 kg/m	...	...	
	1323	Panjur Profili	0,880 kg/m	...	...	
	1322	Panjur Profili	0,591 kg/m	...	...	
	1325	Panjur Profili	0,409 kg/m	...	...	
	1685	Panjur Profili	0,588 kg/m	...	...	
	1138	Panjur Profili	0,580 kg/m	...	...	
	1326	Panjur Profili	0,585 kg/m	...	...	
	1558	Panjur Profili	0,601 kg/m	...	...	
	1327	Panjur Profili	0,451 kg/m	...	...	
	1562	Panjur Profili	0,353 kg/m	...	...	
	1556	Panjur Profili	0,381 kg/m	...	...	

★ Yandaki profil birim ağırlıkları, bilgisayarda hesaplanmış teorik ağırlıklardır.

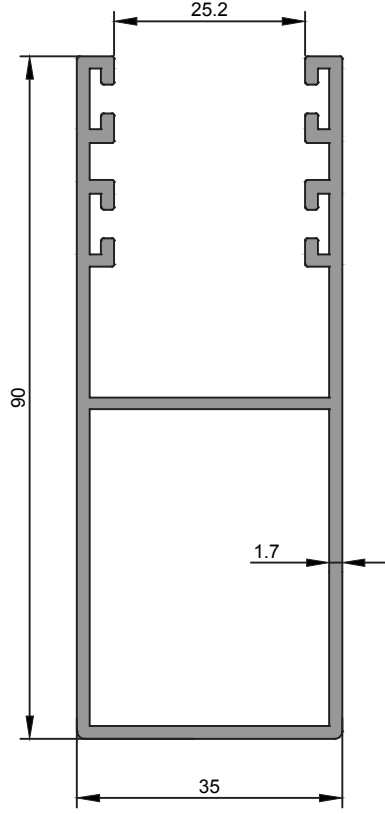
**1324**

Panjur Profili

1,296 kg/m

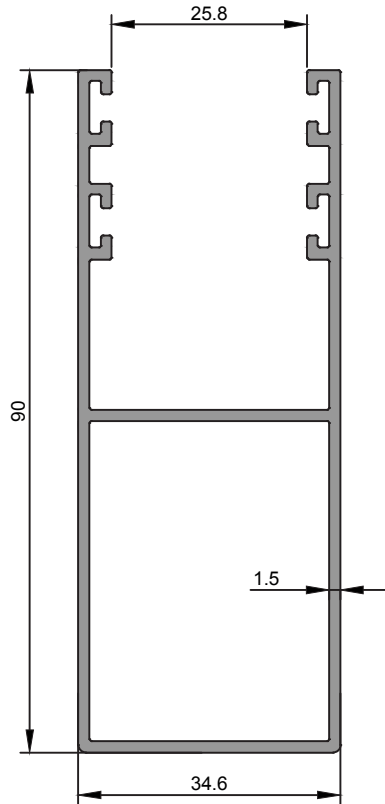
**1686**

Panjur Profili

1,133 kg/m

★ Yandaki profil birim ağırlıkları, bilgisayarda hesaplanmış teorik ağırlıklardır.

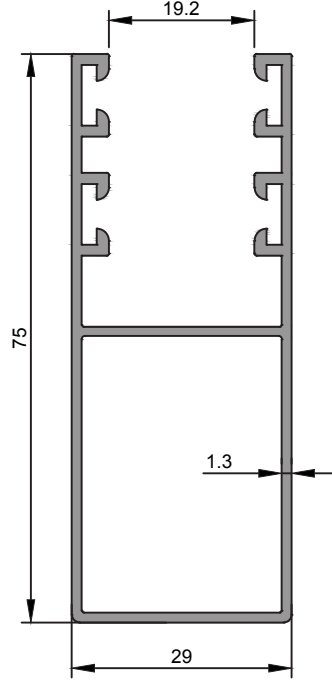

<b>1323</b>
Panjur Profili
0,880 kg/m

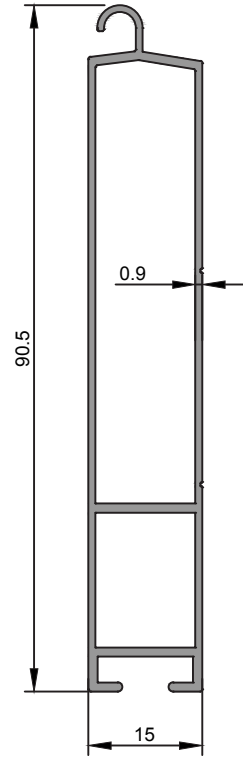

<b>1322</b>
Panjur Profili
0,591 kg/m

★ Yandaki profil birim ağırlıkları, bilgisayarda hesaplanmış teorik ağırlıklardır.

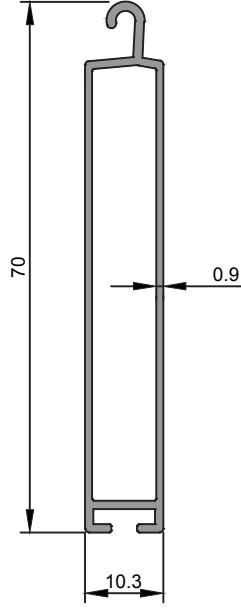

<b>1325</b>
Panjur Profili
0,409 kg/m

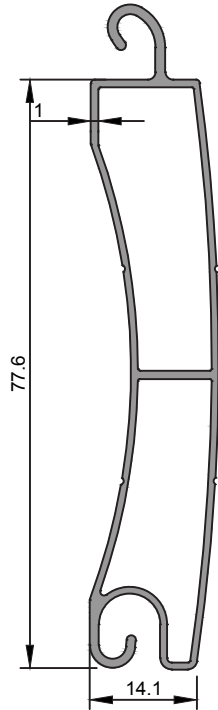

<b>1685</b>
Panjur Profili
0,588 kg/m

★ Yandaki profil birim ağırlıkları, bilgisayarda hesaplanmış teorik ağırlıklardır.

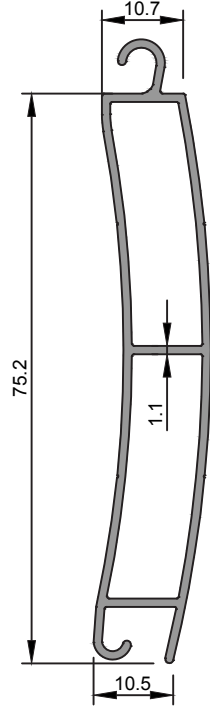

<b>1138</b>
Panjur Profili
0,580 kg/m

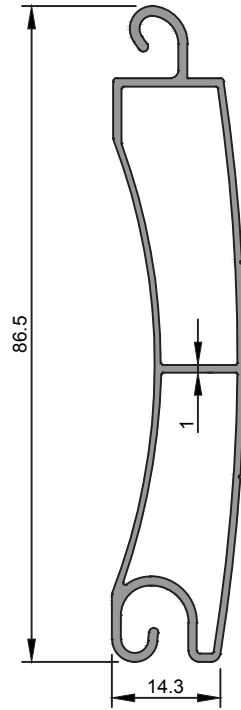

<b>1326</b>
Panjur Profili
0,585 kg/m

★ Yandaki profil birim ağırlıkları, bilgisayarda hesaplanmış teorik ağırlıklardır.

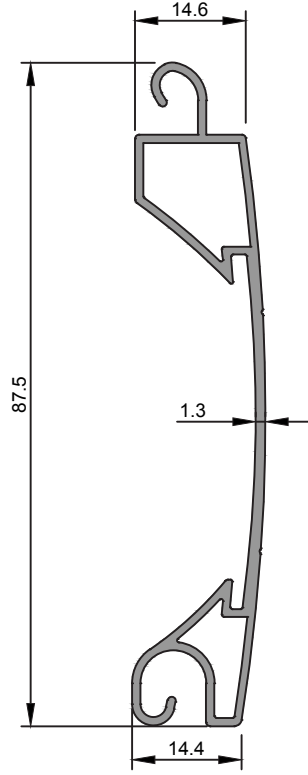

<b>1558</b>
Panjur Profili
0,601 kg/m

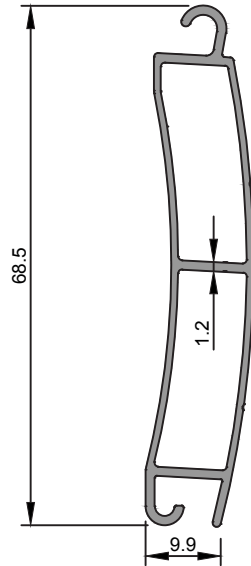

<b>1327</b>
Panjur Profili
0,451 kg/m

★ Yandaki profil birim ağırlıkları, bilgisayarda hesaplanmış teorik ağırlıklardır.

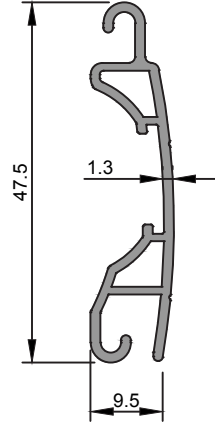

<b>1562</b>
Panjur Profili
0,353 kg/m

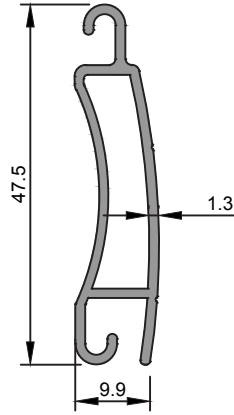

<b>1556</b>
Panjur Profili
0,381 kg/m





## PROFİL KATALOĐU







# DENİZLİK SÜPÜRGELİK PROFİLLERİ

*WINDOWSILL , SKIRTING PROFILES*

★ Profil Ağırlıkları Teorik Olup Teslim Anındaki Ağırlık Geçerlidir

★ *Weight of profiles are theoretical, net weight will valid at the time of delivery.*

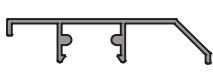
★ Yandaki profil birim ağırlıkları, bilgisayarda hesaplanmış teorik ağırlıklardır.

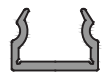
PROFİL KESİTİ	PROFİL KODU	PROFİL ADI	AĞIRLIK	ATALET MOMENTLERİ		SAYFA NO
				$J_x$ (cm <sup>4</sup> )	$J_y$ (cm <sup>4</sup> )	
	1455	...	0,456 kg/m	27,02	0,49	
	1136	...	0,593 kg/m	35,69	0,68	
	1653	...	0,276 kg/m	3,33	0,02	
	1778	...	0,201 kg/m	1,13	0,02	
	1779	...	0,364 kg/m	8,11	0,02	
	1205	...	0,375 kg/m	3,88	0,18	
	1786	...	0,420 kg/m	8,90	0,24	
	1785	...	0,328 kg/m	3,64	0,18	
	1206	...	0,120 kg/m	0,11	0,04	

★ Yandaki profil birim ağırlıkları, bilgisayarda hesaplanmış teorik ağırlıklardır.

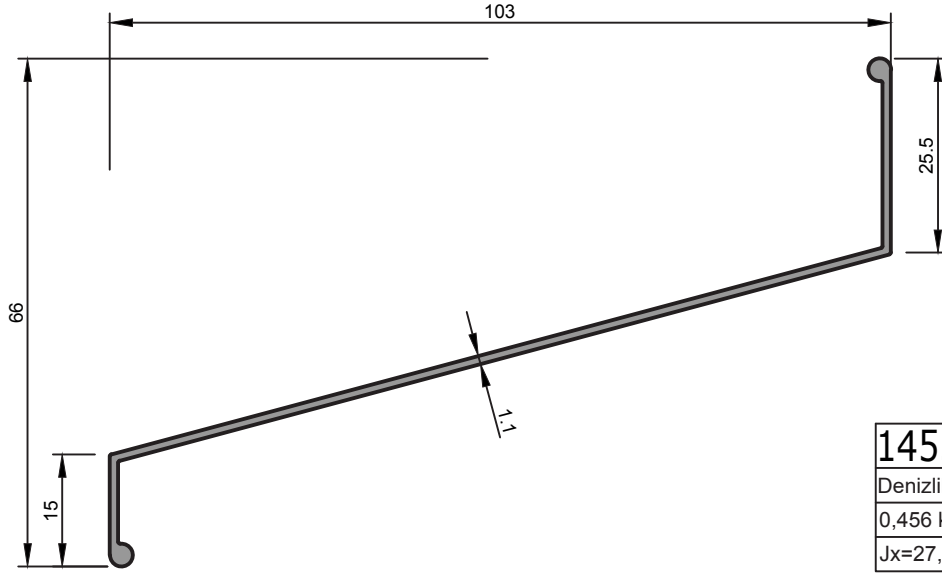

<b>1455</b>
Denizlik Süpürgelik Profili
0,456 kg/m
$J_x=27,02 \text{ cm}^4$ $J_y=0,49 \text{ cm}^4$

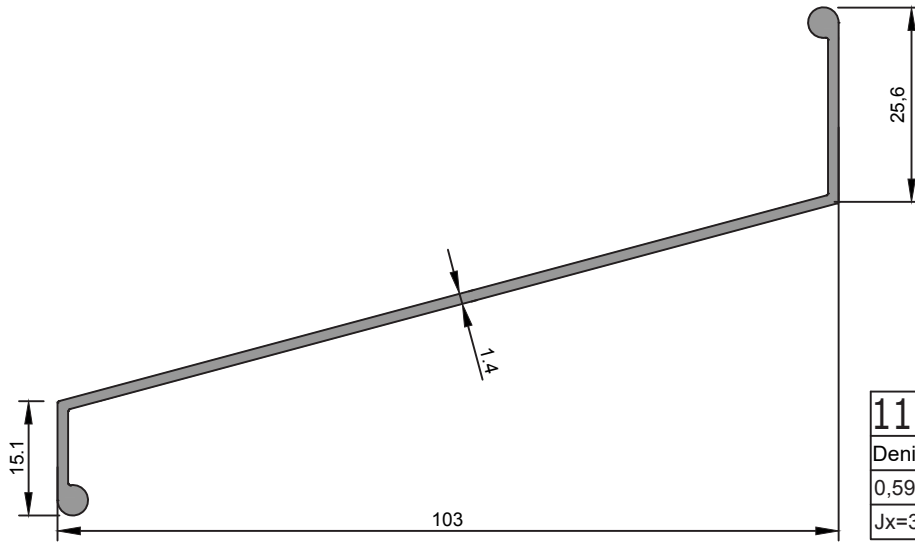

<b>1136</b>
Denizlik Süpürgelik Profili
0,593 kg/m
$J_x=35,69 \text{ cm}^4$ $J_y=0,68 \text{ cm}^4$

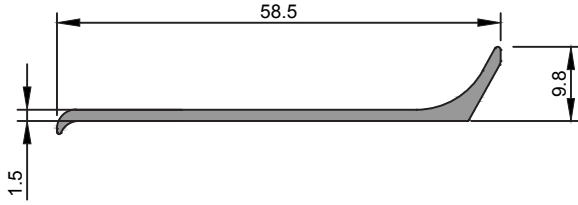

<b>1653</b>
Denizlik Süpürgelik Profili
0,276 kg/m
$J_x=3,33 \text{ cm}^4$ $J_y=0,02 \text{ cm}^4$

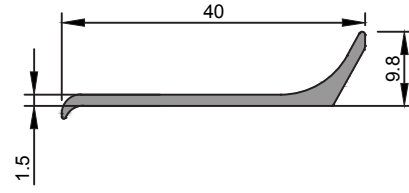

<b>1778</b>
Denizlik Süpürgelik Profili
0,201 kg/m
$J_x=1,13 \text{ cm}^4$ $J_y=0,02 \text{ cm}^4$

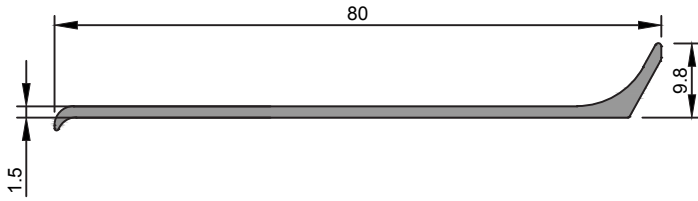

<b>1779</b>
Denizlik Süpürgelik Profili
0,364 kg/m
$J_x=8,11 \text{ cm}^4$ $J_y=0,02 \text{ cm}^4$

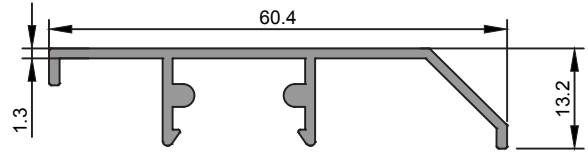

<b>1205</b>
Denizlik Süpürgelik Profili
0,375 kg/m
$J_x=3,88 \text{ cm}^4$ $J_y=0,18 \text{ cm}^4$

★ Yandaki profil birim ağırlıkları, bilgisayarla hesaplanmış teorik ağırlıklardır.

★ Yandaki profil birim ağırlıkları, bilgisayarda hesaplanmış teorik ağırlıklardır.

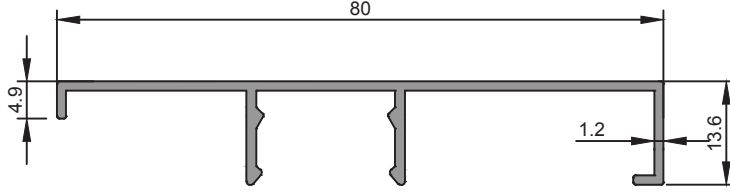
**1786**

Denizlik Süpürgelik Profili

0,420 kg/m

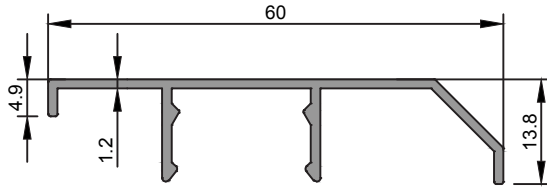
 $J_x=8,90 \text{ cm}^4$   $J_y=0,24 \text{ cm}^4$ **1785**

Denizlik Süpürgelik Profili

0,328 kg/m

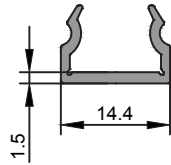
 $J_x=3,64 \text{ cm}^4$   $J_y=0,18 \text{ cm}^4$ **1206**

Denizlik Süpürgelik Profili

0,120 kg/m

 $J_x=0,11 \text{ cm}^4$   $J_y=0,04 \text{ cm}^4$





## PROFİL KATALOĐU

# BORU PROFİLLERİ

## PIPE PROFILES

★ Profil Ağırlıkları Teorik Olup Teslim Anındaki Ağırlık Geçerlidir

★ *Weight of profiles are theoretical, net weight will valid at the time of delivery.*

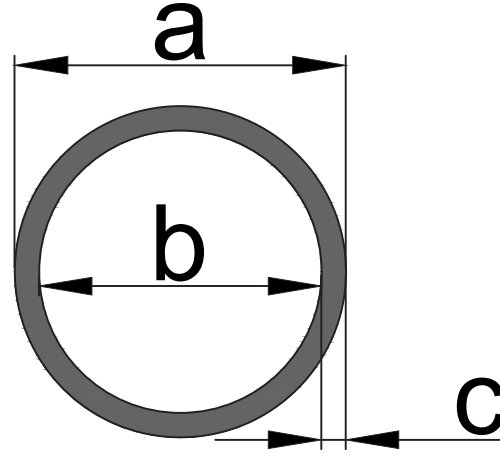

★ Yandaki profil birim ağırlıkları, bilgisayarla hesaplanmış teorik ağırlıklardır.

No	a	b	c	gr/m
1835	11,95	10,15	0,9	85
1540	12	10,1	0,95	89
1763	12	10,2	0,9	85
1525	12,8	10,4	1,2	244
1011	16	12	2	228
1063	16	13	1,5	185
1172	16	6	5	468
1308	16	8	4	409
1606	16	13,6	1,2	151
1804	16	14	1	128
1195	17	8,5	4,5	479
1006	18,4	16,4	1	148
1171	19,4	16,4	1,5	228
1220	20	12	4	545
1555	20	18	1	163
1863	20	18,1	0,95	154
2042	20	17	1,5	236
1146	24	18	3	536
2092	24	22	1	196
1281	24,5	18	3,25	588
1200	25	18	3,5	640
1419	25	23	1	204
1864	25	23,1	0,95	195
2041	25	22	1,5	300
2195	25	20	2,5	479
1048	30	24	3	690
1173	30	26	2	477
1215	30	10	10	1702

No	a	b	c	gr/m
1218	30	22	4	885
1418	30	28	1	246
1865	30	28,1	0,95	235
2193	30	23	3,5	789
1318	45	20,2	12,4	3441
1416	45	35	2	1703
1674	45	8	18,5	4174
2150	55	51	2,0	902
2736	35	31	2,0	562
2641	35	32	1,5	427
2640	35	32,4	1,30	373
2639	19	17	1,00	153
2569	38	35	1,50	466
1837	45	39	3	1072
1603	48	46	1	400
2068	49	27	11	3558
1046	50	45	2,5	1010
1047	50	45	2	1011
1417	50	40	5	1916
2025	50	46,7	1,65	679
2026	50	45,8	2,1	856
1054	50	47	1,5	620
2078	50,5	45	2,75	1118
1346	53	41	6	2400
1673	53	30	11,5	4061
1004	54	50,4	1,8	800
1076	58	20,4	18,8	6274
2495	50	47,4	1,30	539

No	a	b	c	gr/m
1679	60	54	3	1456
1980	60	56,4	1,8	891
1672	70	40,3	14,+7	6973
2000	70	67	1,5	874
2094	70	67,4	1,3	760
1331	80	74	3	1967
1053	40,2	10	15,1	3227
1104	39	30,4	4,3	1270
1147	60	55	2,5	1224
1169	40	36	2	647
1526	10	4	3	179
1541	10	8	1	77
1604	32	30	1	263
1738	32	26	3	1740
1739	45	42,6	1,2	447
1805	8	6	1	59
1836	9,7	8	0,85	64
1926	40	35	2,5	798
1836	8	5	1,5	83
2194	35	29	3	817
1929	8	5	1,5	83
1904	53	8	22,5	5842
2895	20	14	3	434
2928	25	10	7,2	1117
1363	49,9	46,4	1,75	717
2519	19	16,6	1,20	181
3459	32	25	3,5	848
2736	35	31	2	562
1054	50	47	1,5	620



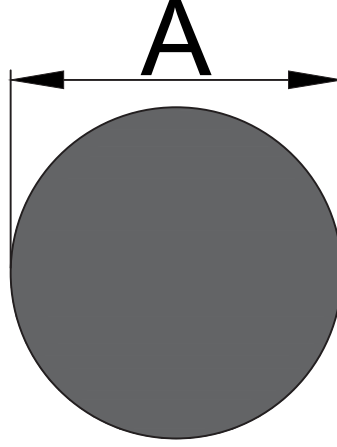

★ Yandaki profil birim ağırlıkları, bilgisayarda hesaplanmış teorik ağırlıklardır.

No	a	gr/m
1776	10	213
1212	16	545
1799	16	545
1381	18	689
1198	19,8	834
1234	22	1030
1197	24,95	1330
1328	30	1915
1329	35	2607
1165	41	3571
1167	51	5536
1282	55	6438
1166	60,5	7790
1227	65,5	9131
2786	16,3	566
2711	4,3	43
2451	6	77
2480	4,9	43





## PROFİL KATALOĐU

# DİKDÖRTGEN VE KARE PROFİLLER

RECTANGULAR AND SQUARE PROFILES

★ Profil Ağırlıkları Teorik Olup Teslim Anındaki Ağırlık Geçerlidir

★ *Weight of profiles are theoretical, net weight will valid at the time of delivery.*

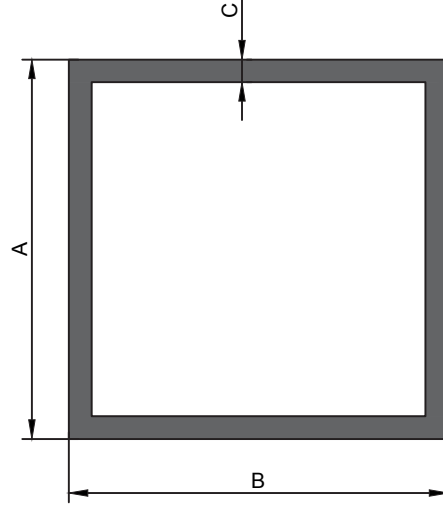

No	A	B	C	gr/m
1196	10	10	1,8	160
1737	12	12	1	119
1992	15	15	2	282
1990	20	20	2	390
1400	20	20	2,1	407
2151	22	22	2	434
1642	25	25	2	499
2578	25	25	1,2	310
1471	30	30	2	607
1352	35	35	1,2	440
1362	40	40	0,8	340
1068	40	40	1,1	464
1344	40	40	2	824
2415	60	60	1,4	889
3123	39,7	39,7	0,8	237
1465	50	50	2	1040
2939	80	80	2	1691

★ Yandaki profil birim ağırlıkları, bilgisayarda hesaplanmış teorik ağırlıklardır.

★ Yandaki profil birim ağırlıkları, bilgisayarda hesaplanmış teorik ağırlıklardır.

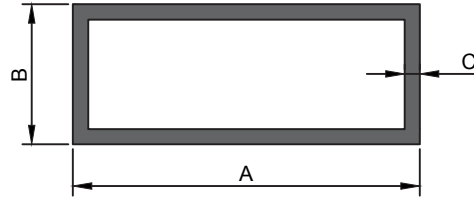

No	A	B	C	gr/m
1420	20	10	1	152
1614	20	10	1,2	180
1069	25	17	1,2	258
1513	25	17	2	412
1400	20	20	1,9	579
1066	40	20	1,2	375
1022	60	20	2	624
1624	80,2	20,2	0,86	453
1433	100	20	0,95	608
1869	100	25	1,3	862
2280	100	25	1,8	1184
1991	40	30	2	715
1415	50	30	2	824
1887	50	30	3	1185
1680	60	30	2	932
1426	70	32	0,8	435
1056	75	32	1,2	680
2421	45	35	1,75	726
1353	50	35	1,2	537
1067	50	40	1,2	570
1410	50	40	1,5	707
2414	95	50	1,5	1154
2423	80	75	1,5	1236
2555	30	20	2	499
2826	80	60	2	1142





## PROFİL KATALOĐU

# KÖŐEBENT, T, U VE LAMA PROFİLLERİ

KÖŐEBENT, T, U AND FLAT BAR PROFILES

★ Profil Ađırlıkları Teorik Olup Teslim Anındaki Ađırlık Geçerlidir

★ *Weight of profiles are theoretical, net weight will valid at the time of delivery.*

★ Yandaki profil birim ağırlıkları, bilgisayarla hesaplanmış teorik ağırlıklardır.

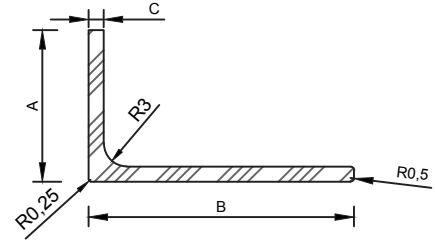
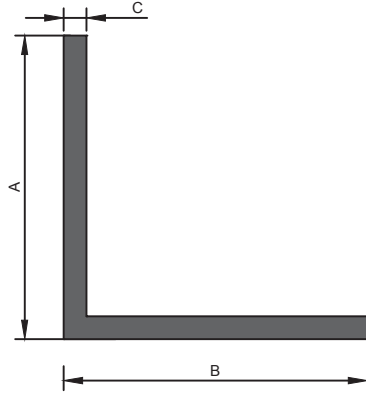

No	A	B	C	gr/m
1772	10	10	1,2	0,61
1127	10	15	1,2	0,77
1771	10	20	1,2	0,94
2300	10	20	2	0,152
1036	14	22	2,4	0,219
1693	15	15	1,4	0,109
1806	15	15	1,5	0,116
2427	15	15	3	0,220
1113	19	30	1,2	0,142
1313	20	19	0,8	0,81
1258	20	20	0,8	0,85
1128	20	20	1,2	0,126
1341	20	20	2	0,206
1342	20	25	2	0,233
1796	20	30	1	0,133
1350	20	30	2	0,260
1769	20	40	1	0,160
1112	20	40	1,2	0,191
1539	20	40	2	0,314
1707	20	53,2	2	0,386
1111	20	60	1,2	0,256
2416	20	80	1,5	0,400
1137	15	15	1,2	0,93

No	A	B	C	gr/m
1105	20	60	1,5	320
1247	25	25	0,8	107
1129	25	25	1,2	159
1514	25	25	2	260
1037	25	25	2,4	310
1706	27,7	53,2	2	427
1250	30	30	0,8	128
1110	30	30	1,2	191
1466	30	30	2	314
1343	30	30	3	463
2534	30	30	1,5	238
1829	30	50	3	626
1108	40	40	1,2	256
1107	40	40	2	422
1114	40	40	4	823
1115	40	60	2	531
2028	40	60	2,5	660
1109	50	50	1,5	398
2283	50	50	3	788
1106	50	50	5	1287
1839	50	85	4	1420
2768	50	20	1,2	224

No	A	B	C	gr/m
1365	54	60	3	907
1367	54	80	3	1070
1370	54	100	3	1230
1369	54	120	3	1395
1748	25	50	1,8	356
1368	25	50	2	395
3432	33	20	1	141
3425	35	25	2	315
3426	25	40	2	342
2518	25	25	1	258
2538	50	35	4	878
2512	80	120	2	1073
2511	50	50	2	531
2510	25	50	2	396
2305	20	20	2	203



★ Yandaki profil birim ağırlıkları, bilgisayarla hesaplanmış teorik ağırlıklardır.

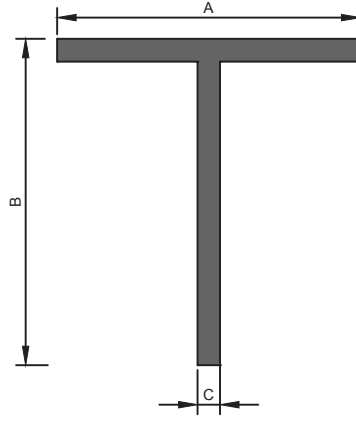

No	A	B	C	gr/m
1123	20	20	1,5	157
1125	20	20	2	206
1124	25	25	2	260
1126	30	30	1,2	191
1564	30	30	1,5	238
1635	30	30	3	463
1639	50	50	2	531
1797	100	60	2	856
2029	100	60	2,5	1067
1809	110	30	2	748
2455	110	50	2	833
2509	100	52	2	813

★ Yandaki profil birim ağırlıkları, bilgisayarla hesaplanmış teorik ağırlıklardır.

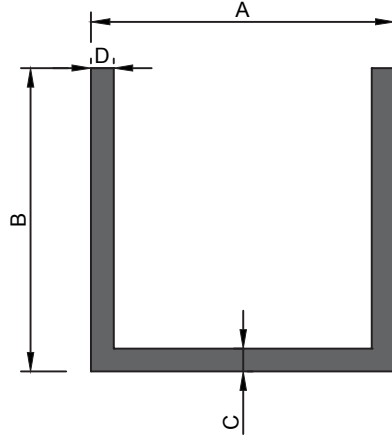

No	A	B	C	D	gr/m
1018	8	19,9	1	1	122
1294	10	20	0,8	0,8	105
1807	13	15	1,5	1,5	163
1949	15	23,5	1,6	1,6	255
1201	25	20	1,2	1,2	203
1629	42	5	1	1	190
1791	48	18,8	1	1	226
1790	50	20	1	1	238
1145	8,2	8,1	0,9	0,9	55
1894	50	50	3	3	1170
1788	69	18,8	1	1	283
3191	21	25	1,2	1,2	223
2777	111	30	2	3	1138
2567	40	20	2	2	412
2247	40	30	1,5	1,5	394

No	A	B	C	D	gr/m
1789	70	20	1	1	292
1634	40	30	2	2	667
1950	50	30	3	3	255
2242	105	11	2	2	661
2301	26	8	2	2	206
2443	20	20	1,5	1,5	233
2537	40	40	4	4	1214
2606	9,8	6	1	1	54
2780	17	17	1,1	1,1	145
2789	14,8	9,4	1,6	1,6	131

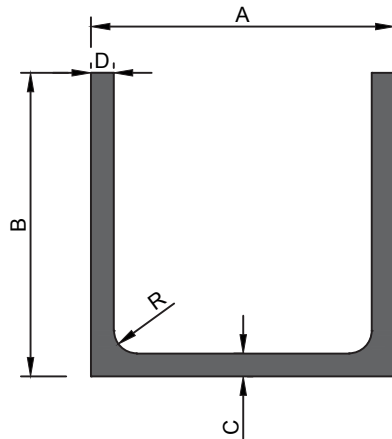

No	A	B	C	D	R	gr/m
3333	23	20	25	25	2	422

★ Yandaki profil birim ağırlıkları, bilgisayarda hesaplanmış teorik ağırlıklardır.

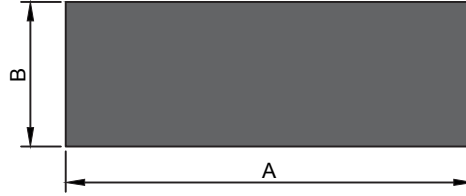

No	A	B	gr/m
1770	10	2	54
1140	15	2,5	102
1958	17	8	369
1029	19,5	4,5	238
1055	20	3	163
2288	20	2	108
1648	20	20	1084
1729	25	25	1694
2282	30	3	244
1938	30	5	407
1959	30	8	650
1351	34	4,8	440
1450	34	3	275
1321	40	3	325
3205	28	23	1745

No	A	B	gr/m
1703	40	5	542
1030	44	10	1192
2366	45	2	244
1448	50	6	813
2424	50	1,5	203
2492	60	1,3	211
1973	60	5	813
2196	70	1,5	285
2425	70	1,6	304
1702	70	8	1518
2888	80	1,4	304
2889	100	1,5	407
1519	100	4	1084
1509	100	5	1355

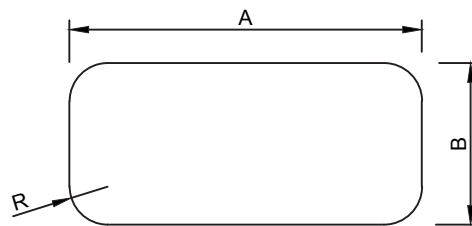

No	A	B	R	gr/m
2529	1485	9.9	1	314





# HASEL GROUP – Worldwide DÜNYA ÇAPINDA HASEL GRUP



HASEL GROUP ALÜMİNYUM TURİZM İTH. İHR. SAN. TİC. LTD. ŞTİ.

Oruçreis Mah. Tekstil Kent Cad. B14 Blok No: 10-V No: 213 (2.Kat)  
Tekstil Kent Ticaret Merkezi Esenler / İstanbul / Türkiye



[www.haseldisticaret.com](http://www.haseldisticaret.com)



[info@haseldisticaret.com](mailto:info@haseldisticaret.com)